

# LS2TR30-1200Q8

## Light Screen for Machine Safety Applications – Receiver

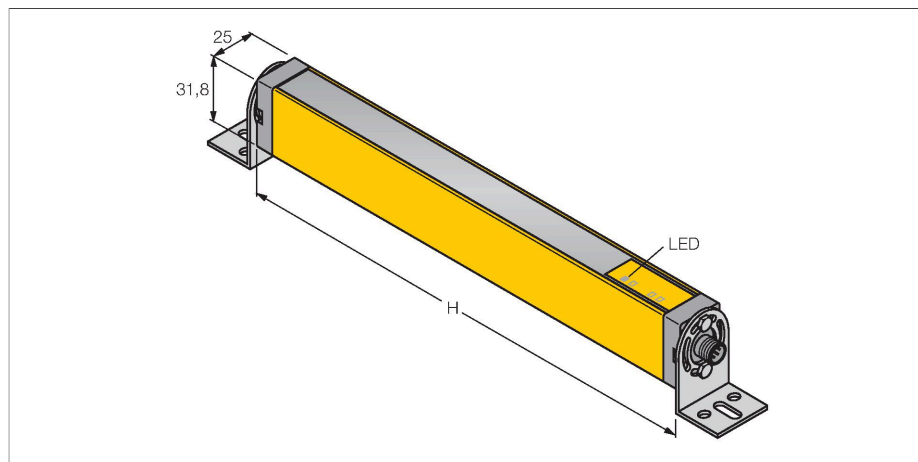

### Features

- Male M12 × 1, 8-pin
- Protection class IP65
- Scan field 1200 mm
- Resolution 30 mm
- Internal testing in 500 ms cycle
- Range 15 m
- Operating voltage 24 VDC +15 %
- Switching output without TRIP
- Type 2 acc. to IEC 61496-1,-2; category 2  
PLd acc. to EN ISO 13849-1; SIL2 acc. to IEC 61508

### Wiring diagram

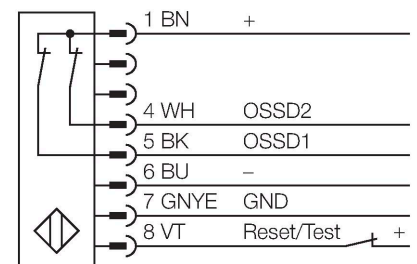

### Functional principle

The safety light curtain consists of an emitter and a receiver. The system is optically synchronized, making the wiring between emitter and receiver redundant. The receiver's safety switching outputs are directly connected to a load relay and trigger an immediate stop of the dangerous machine cycle. Due to the dual-channel design of the switching device, personal safety degree type 2 acc. to IEC 61496 and category 2 acc. to EN 9541 are fulfilled.

### Technical data

Type	LS2TR30-1200Q8
ID	3073541
<b>Optical data</b>	
Function	Light screen
Optical resolution	30 mm
Range	200...15000 mm
Scan field	1200 mm
Number of beams	64
With muting function	no
Scan Code	None
<b>Electrical data</b>	
Operating voltage	20...28 VDC
Residual ripple	< 15 % U <sub>ss</sub>
DC rated operational current	≤ 90 mA
No-load current	≤ 90 mA
Max. current safe output	500 mA
Output function	2 x NC (normally closed), 2 x PNP
Current output	500 mA
Number of safe semiconductor outputs	2
Response time typical	< 22 ms
With restart interlock	no
Blanking function	no
<b>Mechanical data</b>	
Design	Rectangular, EZ-Screen
Dimensions	31.8 x 25.2 x 1264 mm
Housing material	Metal, AL, Yellow polyester
Lens	plastic, Acrylic

## Technical data

Cascadable	No
Electrical connection	Connector, M12 × 1
Number of cores	8
Ambient temperature	0...+55 °C
Protection class	IP65
Power-on indication	LED, Green
Switching state	LED, Red
<b>Tests/approvals</b>	
Vibration resistance	10-55 Hz at 0.35 mm
Shock test	10 g at 16 ms (6000 cycles)
Approvals	CE, cULus listed