

EVT301

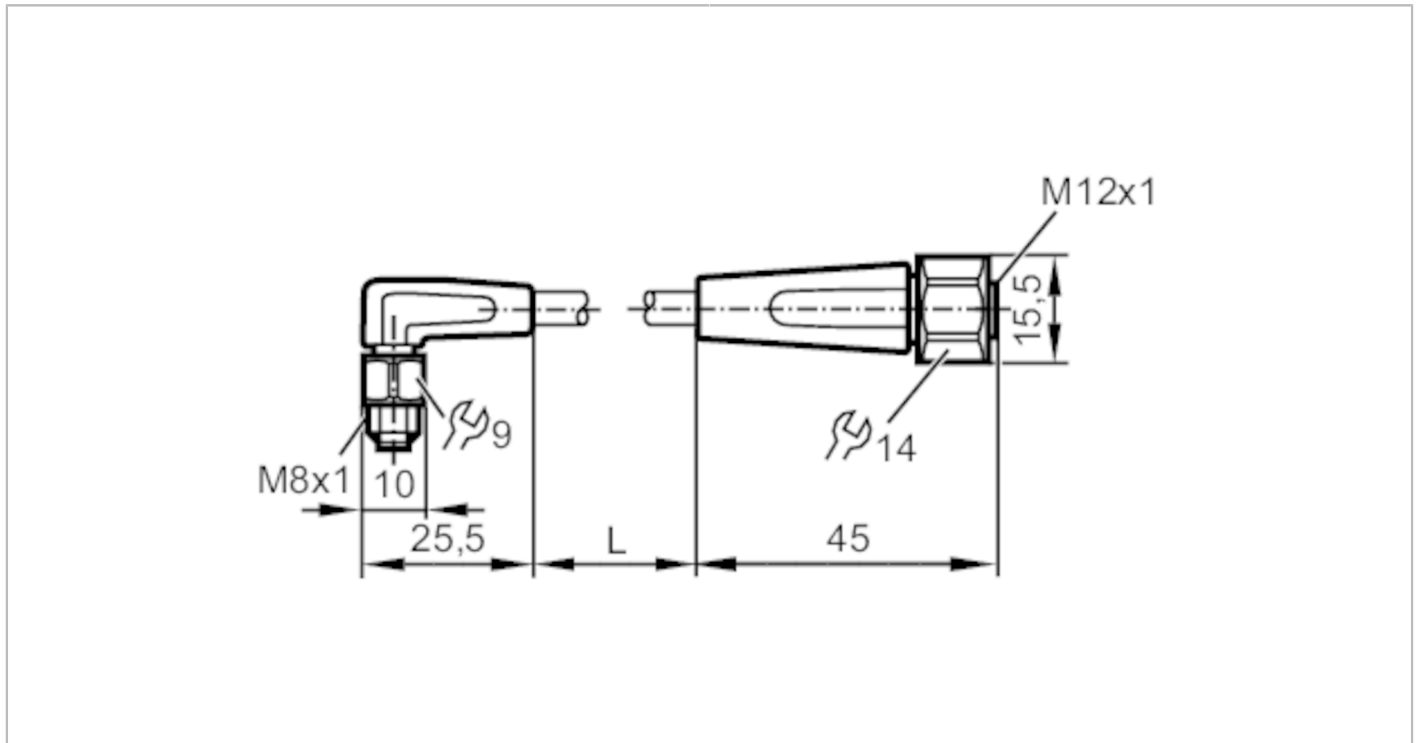

Connection cable

VDOGH030VAS00,3E03STAF030VAS



Application	
System	Free from silicone; gold-plated contacts; Drag chain suitability
Application	sanitary and wet areas in the food industry
Free from silicone	yes
Electrical data	
Operating voltage [V]	< 50 AC / < 60 DC
Protection class	III
Max. current load total [A]	3
Operating conditions	
Ambient temperature [°C]	-25...80
Note on ambient temperature	cULus: ...50 °C
Ambient temperature (moving) [°C]	5...80
Note on ambient temperature (moving)	cULus: ...50 °C
Protection	IP 65; IP 67; IP 68; IP 69K

EVT301



Connection cable

VDOGH030VAS00,3E03STAF030VAS

Mechanical data		
Weight [g]	36.2	
Material	housing: PVC orange; sealing: EPDM	
Material nut	stainless steel (1.4404 / 316L)	
Drag chain suitability	yes	
Drag chain suitability	Bending radius for flexible applications	min. 10 x cable diameter
	Travel speed	max. 3.3 m/s for a horizontal travel length of 5 m and max. acceleration of 5 m/s ²
	Bending cycles	> 1 Mio.
	Torsional strain	± 180 °/m

Remarks	
Pack quantity	1 pcs.

Electrical connection - plug

Connector: 1 x M8, angled; coding: A; Locking: stainless steel (1.4404 / 316L); Contacts: gold-plated; Tightening torque: 0.3...0.5 Nm

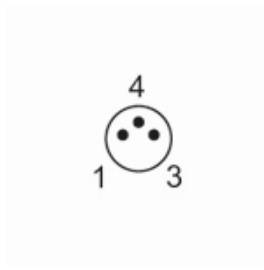

Electrical connection

Cable: 0.3 m, PVC, orange, Ø 4.9 mm; 3 x 0.34 mm² (42 x Ø 0.1 mm)

Connection

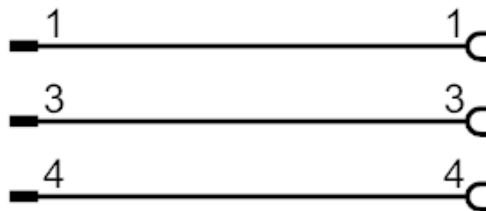

Electrical connection - Socket

Connector: 1 x M12, straight; coding: A; Locking: stainless steel (1.4404 / 316L); Contacts: gold-plated; Tightening torque: 0.6...1.5 Nm

EVT301



Connection cable

VDOGH030VAS00,3E03STAF030VAS

