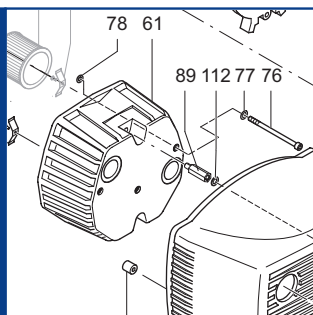

**VT 4.40**

**SERVICE**

**BECKER**  
D-42279 Wuppertal  
www.becker-international.com

year

No. **A**  **Index Variante**

type **VT 4.40-XX**

frequency  Hz

speed  min<sup>-1</sup>

power required  kW

inlet capacity  m<sup>3</sup>/h

pressure +  mbar

vacuum -  mbar

Made in  Germany



**Ersatzteilliste**  
**Spare parts list**  
**Liste de pièces de rechange**  
**Listino pezzi di ricambio**  
**Lista de piezas de recambio**  
**Lista de peças sobresselentes**  
**Reserveonderdelenlijst**  
**Atsarginių dalių sąrašas**  
**Varuosad nimekirja**  
**Rezerves daļu saraksts**

**Reservedelsliste**  
**Reservdelslista**  
**Varaosuettelo**  
**Reservedelsliste**  
**Wykaz części zamiennych**  
**Tartalékalkatrész lista**  
**Seznam náhradních dílů**  
**Seznam nadomestnih delov**  
**Zoznam náhradných dielov**  
**Rezervni dijelovi popis**

**Lista pieselor de schimb**  
**Páirteanna spártha liosta**  
**Κατάλογος ανταλλακτικών**  
**Yedek parça listesi**  
**Списък на резервните части**  
**Перечень запасных частей**  
**スペアパーツリスト**  
**예비 부품 목록**  
**备用零件目录**

**SERVICE**

[www.becker-international.com](http://www.becker-international.com)

**Sales and service network**

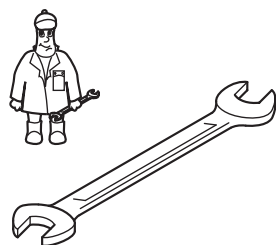

Pos.	Menge <sup>2)</sup> Quantity Quantité Quantità Cantidad	Bestell-Nr. Ident No. No. Identification No. Identificazione No. de pedido	Bezeichnung Description Designation Designazione Descripción
24	SATZ/KIT	901352 00007	Schieber, Rotor Vane, Palette, Empujador
72	1	909505 00000	Filterpatrone, Filter cartridge, Cartouche Filtrante, Cartuccia filtro, Cartucho de filtro
74	1	909529 00000	- VT 4.40/0-65 Filterpatrone, Filter cartridge, Cartouche Filtrante, Cartuccia filtro, Cartucho de filtro

<sup>2)</sup> erforderliche Bestellmenge / necessary order quantity / quantité nécessaire / quantità di ordinazione necessari / cantidad necesario

**Wartung**  
**Maintenance**  
**Entretien**  
**Manutenzione**  
**Mantenimiento**



VT 4.40

Standard



Variante



VT 4.40/XX

①

- 1~ Einphasenwechselstrom
- 1~ single-phase AC
- 1~ AC monophasé
- 1~ AC monofase
- 1~ AC monofásica

② /0-65

- Abluftanschluß oben
- exhaust connection obove
- raccord d'évacuation d'air en haut
- allacciamento emissioni gassose disopra
- conexión de aire de escape superior

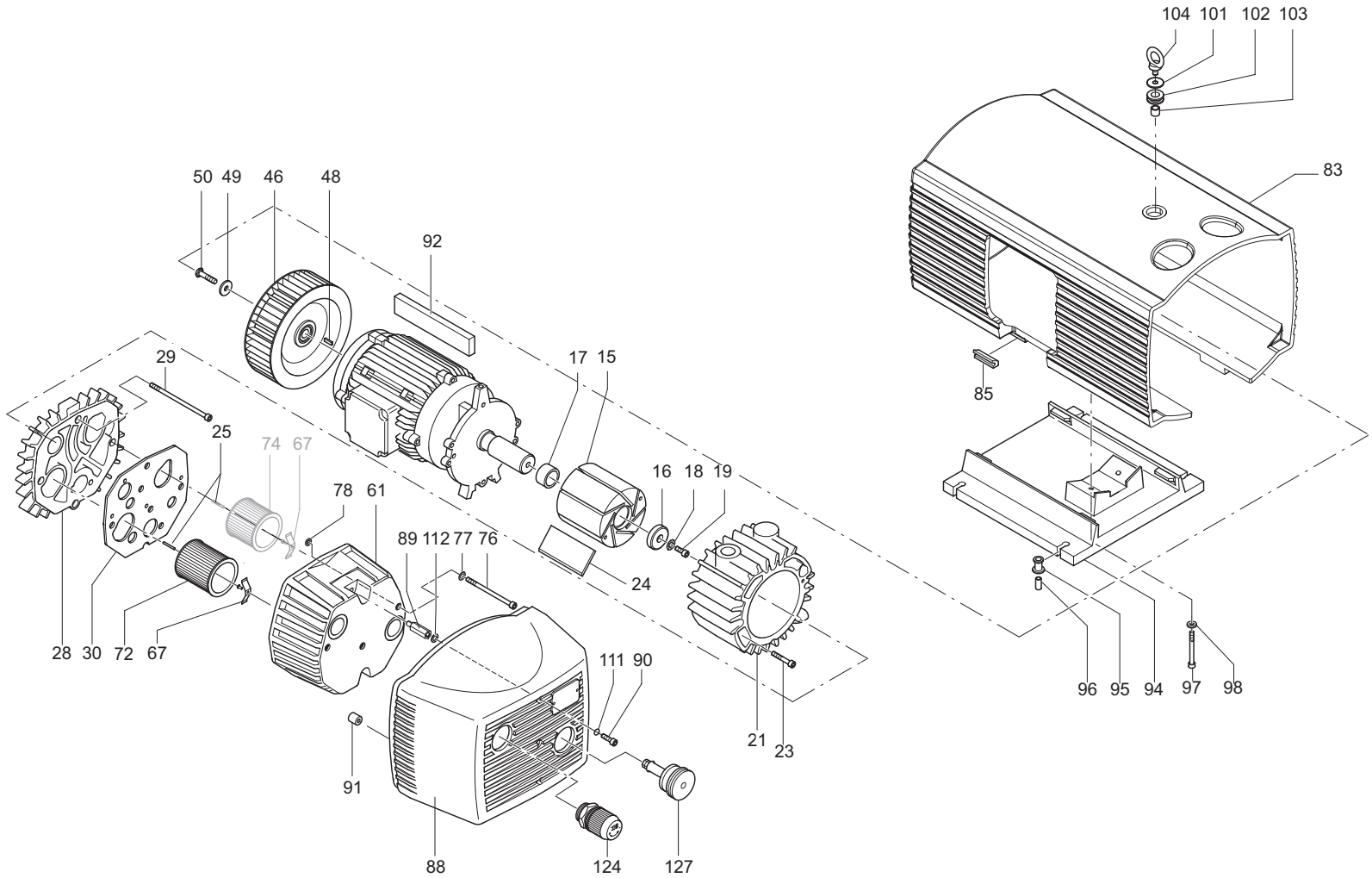

SERVICE ? i

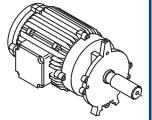

C = ? µF  
U = ? V

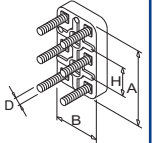
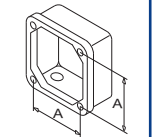
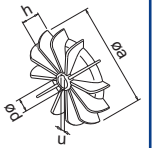
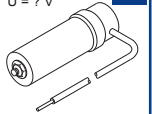

<b>A</b> INDEX	Pos.	Bestell Nr.	Beschreibung	
<b>VT 4.40</b>	15	020000 16500	KOLBEN	
	16	016800 16500	SPANNSCHEIBE	
	17	911008 00000	STAR-TOLERANZRING	
	18	949203 00000	ZAHNSCHEIBE	
	19	945320 00000	INNENSECHSKANTSCHRAUBE	
	21	000102 16500	GEHÄUSE	
	23	945322 00000	INNENSECHSKANTSCHRAUBE	
	24	901352 00007	<b>SCHIEBER, KOHLE (SATZ)</b>	
	25	952009 00000	SPANNHÜLSE	
	28	000710 16500	SEITENDECKEL	
	29	945374 00000	INNENSECHSKANTSCHRAUBE	
	30	008900 16500	DICHTUNG	
46	902300 26200	VENTILATOR MIT NABE		
48	947713 00000	PASSFEDER		
49	949454 00000	U-SCHEIBE		
50	901804 00000	WELLENENDSCHRAUBE TUFLOK		
61	004803 27600	FILTERDECKEL		
67	009000 16300	ANPRESSFEDER		
72	909505 00000	<b>FILTERPATRONE (1x)<sup>1)</sup></b>		
76	945373 00000	INNENSECHSKANTSCHRAUBE		
77	948021 00000	DICHTRING		
78	913161 00000	O-RING		
83	006801 27600	GERÄTEHAUBE		
85	951920 00000	GUMMIFORMTEIL		
88	006802 27600	GERÄTEHAUBE		
89	068000 27500	DISTANZSTÜCK		
90	945320 00000	INNENSECHSKANTSCHRAUBE		
91	951922 00000	GUMMIFORMTEIL		
92	964109 00000	KANTENSCHUTZ		
94	015100 27600	FUSS		
95	951921 00000	GUMMIFORMTEIL		
96	068000 27600	DISTANZSTÜCK		
97	945328 00000	INNENSECHSKANTSCHRAUBE		
98	949451 00000	UNTERLEGSCHNEIBE		
101	833903 99597	VENTILTÄLLER		
102	951906 00000	KABELTÜLLE		
103	068002 16500	DISTANZROHR		
104	548800 16300	RINGSCHRAUBE		
111	913161 00000	O-RING		
112	741300 27600	GUMMISCHEIBE		
124	736001 99613	VAKUUMREGULIERVENTIL		
127	727502 06000	ABBLASEVENTIL		

<sup>1)</sup> erforderliche Bestellmenge / Wartung

<b>A</b> INDEX	Pos.	Ident No.	Description	
<b>VT 4.40</b>	15	020000 16500	ROTOR	
	16	016800 16500	CLAMPING DISC	
	17	911008 00000	STAR-TOLERANCE-RING	
	18	949203 00000	TOOTHED SPRING WASHER	
	19	945320 00000	SOCKET HEAD SCREW	
	21	000102 16500	PUMP BODY	
	23	945322 00000	SOCKET HEAD SCREW	
	24	901352 00007	<b>CARBON VANES (KIT)</b>	
	25	952009 00000	LOCATING PIN	
	28	000710 16500	LID	
	29	945374 00000	SOCKET HEAD SCREW	
	30	008900 16500	GASKET	
46	902300 26200	FAN		
48	947713 00000	KEY		
49	949454 00000	WASHER		
50	901804 00000	SHAFT END BOLT		
61	004803 27600	FILTER COVER		
67	009000 16300	BLADE SPRING		
72	909505 00000	<b>FILTER CARTRIDGE (1x)<sup>1)</sup></b>		
76	945373 00000	SOCKET HEAD SCREW		
77	948021 00000	SEALING RING		
78	913161 00000	O-RING		
83	006801 27600	PROTECTING HOOD		
85	951920 00000	RUBBER ELEMENT		
88	006802 27600	PROTECTING HOOD (FRONT)		
89	068000 27500	SPACER		
90	945320 00000	SOCKET HEAD SCREW		
91	951922 00000	RUBBER ELEMENT		
92	964109 00000	EDGE PROTECTION		
94	015100 27600	FOOT		
95	951921 00000	RUBBER ELEMENT		
96	068000 27600	SPACING COLLAR		
97	945328 00000	SOCKET HEAD SCREW		
98	949451 00000	WASHER		
101	833903 99597	DISC		
102	951906 00000	RUBBER BUSHING		
103	068002 16500	SPACER TUBE		
104	548800 16300	EYE SCREW		
111	913161 00000	O-RING		
112	741300 27600	RUBBER DISC		
124	736001 99613	VACUUM REGULATING VALVE		
127	727502 06000	BLOW-OFF VALVE		

<sup>1)</sup> necessary order quantity / maintenance

A INDICE	Pos.	No. Identification	Designation		
VT 4.40	15	020000 16500	PISTON		
	16	016800 16500	DISQUE DE SERRAGE		
	17	911008 00000	BAGUE STAR		
	18	949203 00000	DENT DISQUE		
	19	945320 00000	VIS HEXAGONALE INTERNE		
	21	000102 16500	CORP DE POMPE		
	23	945322 00000	VIS HEXAGONALE INTERNE		
	24	901352 00007	PALETTE DE CHARBON (KIT)		
	25	952009 00000	DOVILLE DE ETRAGE		
	28	000710 16500	COUVERCLE		
	29	945374 00000	VIS HEXAGONALE INTERNE		
	30	008900 16500	JOINT		
46	902300 26200	VENTILATEUR			
48	947713 00000	CLAVETTE			
49	949454 00000	RONDELLE			
50	901804 00000	VIS BOUT D'ARBRE			
61	004803 27600	COUVERCLE DU FILTRE			
67	009000 16300	RESSORT-JAME			
72	909505 00000	CARTOUCHE FILTRANTE (1x) <sup>1)</sup>			
76	945373 00000	VIS HEXAGONALE INTERNE			
77	948021 00000	JOINT			
78	913161 00000	ANNEAU-O			
83	006801 27600	CARTER PROTECTEUR			
85	951920 00000	ELEMENT EN CAOUTCHOUC			
88	006802 27600	CARTER PROTECTEUR			
89	068000 27500	ENTRETOISE			
90	945320 00000	VIS HEXAGONALE INTERNE			
91	951922 00000	ELEMENT EN CAOUTCHOUC			
92	964109 00000	PROTECTION D'ARETE			
94	015100 27600	PIED			
95	951921 00000	ELEMENT EN CAOUTCHOUC			
96	068000 27600	DONILLE D'ECARMENT			
97	945328 00000	VIS HEXAGONALE INTERNE			
98	949451 00000	RONDELLE			
101	833903 99597	PLATEAU DE SOUPE			
102	951906 00000	PROTECTION EN CAOUTCHOUC			
103	068002 16500	TUBE D'ECARTEMENT			
104	548800 16300	PITON			
111	913161 00000	ANNEAU-O			
112	741300 27600	RONDELLE DE CAOUTCHOUC			
124	736001 99613	SOUPAPE REGLAGE VIDE			
127	727502 06000	SILENCIEUX			



<sup>1)</sup> quantité nécessaire / entretien

A INDICE	Pos.	No. Identificazione	Designazione		
VT 4.40	15	020000 16500	ROTORE		
	16	016800 16500	DISCO DI FISSAGGIO		
	17	911008 00000	STAR-ANELLO TOLLERANZA		
	18	949203 00000	DISCO A DENTE		
	19	945320 00000	VITE ESAGONALE INTERNA		
	21	000102 16500	CARCASSA		
	23	945322 00000	VITE ESAGONALE INTERNA		
	24	901352 00007	PALETTE DI CHARBONE (KIT)		
	25	952009 00000	SPINE DI RISCONTRO		
	28	000710 16500	COPERCHIO		
	29	945374 00000	VITE ESAGONALE INTERNA		
	30	008900 16500	GUARNIZIONE		
46	902300 26200	VENTILATORE			
48	947713 00000	CHIAVETTA			
49	949454 00000	RONDELLA			
50	901804 00000	VITE DI CHIUSURA ALBERO			
61	004803 27600	COPERCHIO FILTRO			
67	009000 16300	MOLLA			
72	909505 00000	CARTUCCIA FILTRO (1x) <sup>1)</sup>			
76	945373 00000	VITE ESAGONALE INTERNA			
77	948021 00000	ANELLO GUARNIZIONE			
78	913161 00000	ANELLO-O			
83	006801 27600	CAPOTO DI PRTEZIONE			
85	951920 00000	ELEMENTO IN GOMMA			
88	006802 27600	CARTER DI PROTEZIONE			
89	068000 27500	SPAZIATORE			
90	945320 00000	VITE ESAGONALE INTERNA			
91	951922 00000	ELEMENTO IN GOMMA			
92	964109 00000	LISTELLO DI PROTEZIONE			
94	015100 27600	PIEDE			
95	951921 00000	ELEMENTO IN GOMMA			
96	068000 27600	BOCCOLA DISTANZIATRICE			
97	945328 00000	VITE ESAGONALE INTERNA			
98	949451 00000	RONDELLE			
101	833903 99597	PIATELLO DELLA VALVOLA			
102	951906 00000	PROTEZIONE IN GOMMA			
103	068002 16500	TUBO DISTANZA			
104	548800 16300	GANCIO			
111	913161 00000	ANELLO-O			
112	741300 27600	RONDELLE IN GOMMA			
124	736001 99613	VALVOLA REGOLAZIONE VUOTO			
127	727502 06000	SILENZIATORE			

<sup>1)</sup> quantità di ordinazione necessari / manutenzione

A INDICE	Pos.	No. De pedido	Descripción	
VT 4.40	15	020000 16500	ÉMBOLO	
	16	016800 16500	ARANDELA TENSORA	
	17	911008 00000	ANILLO DE TOLERANCIA STAR	
	18	949203 00000	POLEA DENTADA	
	19	945320 00000	TORNILLO HEXAGONAL INTERIOR	
	21	000102 16500	CARCASA	
	23	945322 00000	TORNILLO HEXAGONAL INTERIOR	
	24	901352 00007	<b>EMPUJADOR DE CARBÓN (KIT)</b>	
	25	952009 00000	CASQUILLO TENSOR	
	28	000710 16500	TAPA LATERAL	
	29	945374 00000	TORNILLO HEXAGONAL INTERIOR	
	30	008900 16500	JUNTA	
	46	902300 26200	VENTILADOR CON CUBO	
	48	947713 00000	LENGÜETA DE AJUSTE	
	49	949454 00000	ARANDELA	
	50	901804 00000	TORNILLO TERMINAL DE ÁRBOL TUFLOK	
	61	004803 27600	TAPA DE FILTRO	
	67	009000 16300	MUELLE DE PRESIÓN	
	72	909505 00000	<b>CARTUCHO DE FILTRO (1x) <sup>1)</sup></b>	
	76	945373 00000	TORNILLO HEXAGONAL INTERIOR	
	77	948021 00000	ANILLO DE JUNTA	
	78	913161 00000	JUNTA TÓRICA	
	83	006801 27600	CAPERUZA DE APARATO	
	85	951920 00000	PIEZA DE ORMA DE GOMA	
	88	006802 27600	CAPERUZA DE APARATO	
	89	068000 27500	PORTABOQUILLA	
	90	945320 00000	TORNILLO HEXAGONAL INTERIOR	
91	951922 00000	PIEZA DE ORMA DE GOMA		
92	964109 00000	PROTECCIÓN DE CANTOS		
94	015100 27600	PIE		
95	951921 00000	PIEZA DE ORMA DE GOMA		
96	068000 27600	PIEZA DISTANCIADORA		
97	945328 00000	TORNILLO HEXAGONAL INTERIOR		
98	949451 00000	ARANDELA		
101	833903 99597	PLATILLO DE VÁLVULA		
102	951906 00000	BOQUILLA DE CABLE		
103	068002 16500	TUBO DISTANCIADOR		
104	548800 16300	TORNILLO DE CÁNCAMO		
111	913161 00000	JUNTA TÓRICA		
112	741300 27600	ARANDELA DE GOMA		
124	736001 99613	VÁLVULA REGULADORA DE VACÍO		
127	727502 06000	VÁLVULA DE BARRIDO		

<sup>1)</sup> cantidad necesario / mantenimiento

VT 4.40	Variante 	Pos. <sup>2)</sup>	Bestell Nr. / Ident No. / No. Identification / No. Identificazione / No. De pedido		Beschreibung / Description / Designation / Designazione / Desripcion
					
① 1~ Einphasenwechselstrom 1~ single-phase AC 1~ AC monophasé 1~ AC monofase 1~ AC monofásica		13	742002 30000		KABEL / CABLE / CABLE / CAVO / CABLE
		83	006805 27600	<del>006804 27600</del>	HAUBE / PROTECTING HOOD / CARTER PROTECTEUR / CARTER DI PROTEZIONE / CAPERUZA
		94	015101 27600	<del>015100 27600</del>	FUSS / FOOT / PIED / PIEDE / PIE
② /0-65 - Abluftanschluß oben - exhaust connection obove - raccord d'évacuation d'air en haut - allacciamento emissioni gassose disopra - conexión de aire de escape superior		21	000100 16500	<del>000102 16500</del>	GEHÄUSE / PUMP BODY / CORP DE POMPE / CARCASSA / CARCASA
		28	000700 16500	<del>000710 16500</del>	SEITENDECKEL / LID / COUVERCLE / COPERCHIO / TAPA LATERAL
		74	909529 00000		FILTERPATRONE / FILTER CARTRIDGE / CARTOUCHE FILTRANTE / CARTUCCIA FILTRO / CARTUCHO DE FILTRO
		83	006806 27600	<del>006804 27600</del>	HAUBE / PROTECTING HOOD / CARTER PROTECTEUR / CARTER DI PROTEZIONE / CAPERUZA

<sup>2)</sup> variantenabhängige Bauteile / variant-dependent components / composants variante-dependantes / componenti variante-dispendenti / componentes variante-dependientes