

Technical specifications

PVS10520201013

The CGS4-C junction box is able to connect several load cells: it synchronizes measurements and it ensures correct and accurate weight values. The CGS4-C junction box collects the signals of the individual cells and translates them into a single signal. Our junction boxes are equipped with a quick connector for the connection to our Tester 1008, which allows the immediate control of the signals of the single cells and the system diagnostics.

Temperature range:	-10 ÷ +50 °C (max 85% humidity without condensation)
Storage temperature:	-20 ÷ +70 °C
Drilling template:	140 x 110 mm (L x H)
Dimensions:	160 x 160 x 90 mm (L x H x D)

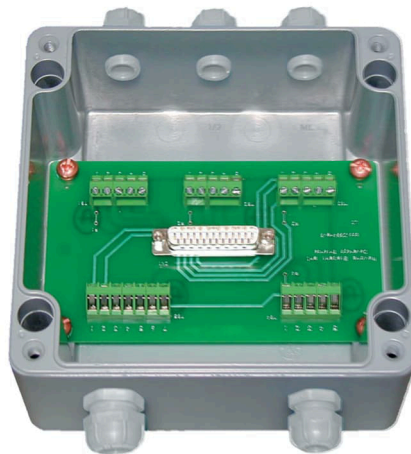

All indicated data may be changed without notice.
All the measures indicated are expressed in millimeters (mm).



All indicated data may be changed without notice.
All the measures indicated are expressed in millimeters (mm).

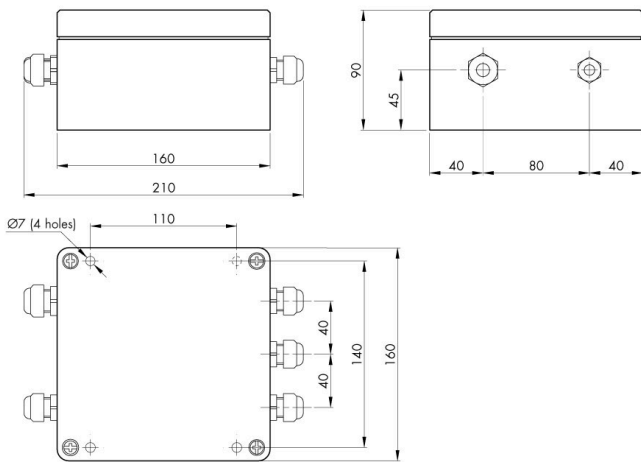

Aluminium housing

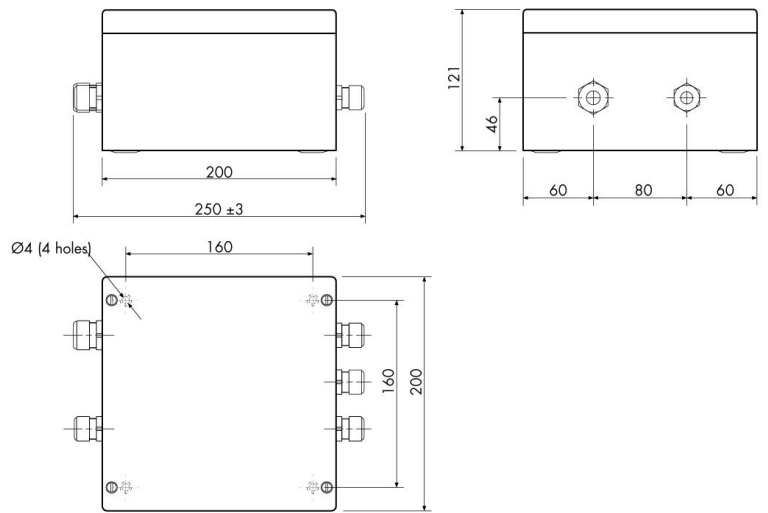

Stainless Steel housing

LOAD CELLS COLOUR CODE

+Exc	Red	Red/Green	Red	Red/Blue
-Exc	Black	Black	White	Black/Brown
+Sgn	Green	Green/White	Green	Green
-Sgn	White	Red/White	Blue	White
Shd	Shield	Shield	Shield	Shield
	SENSORTRONICS	NOBEL	MINEBEA	PAVONE

All indicated data may be changed without notice.
 All the measures indicated are expressed in millimeters (mm).

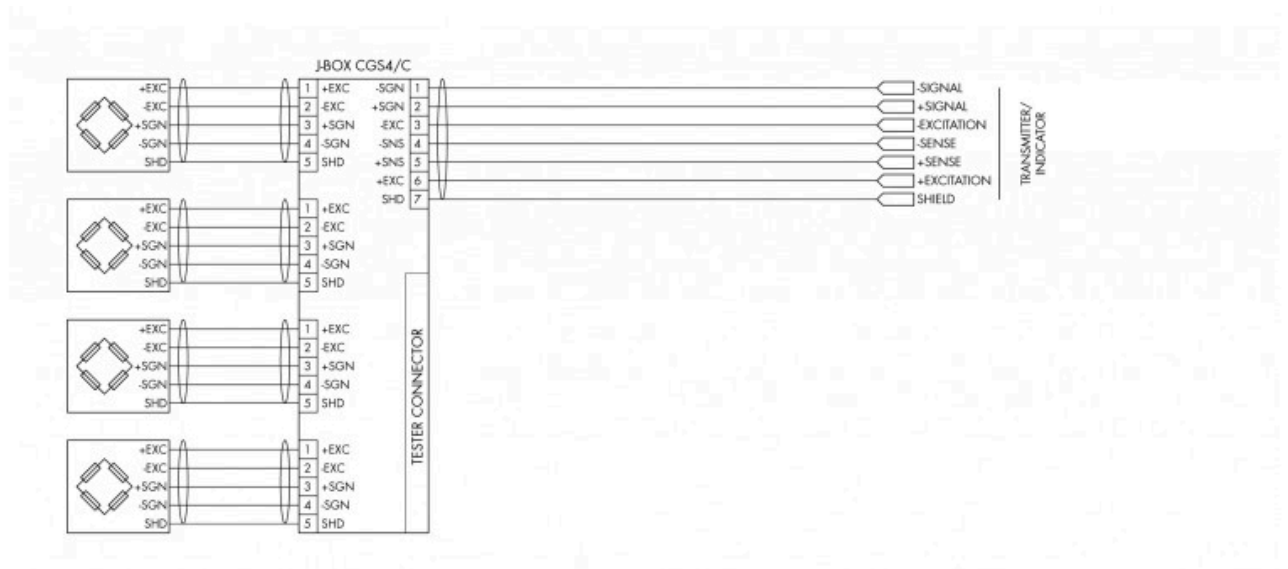

All indicated data may be changed without notice.
 All the measures indicated are expressed in millimeters (mm).