

# TECHNOLOGY IN MOTION

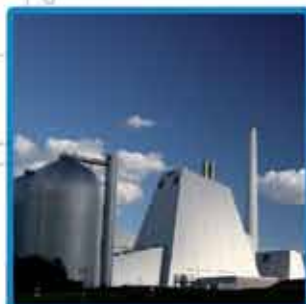

INDUSTRIAL



POWER GEN



OIL & GAS

## SMT16B series

Dry & submersible screw pumps  
for industrial applications - 40 bar pressure



### Three screw pumps

Three screw pumps represent the largest class of multiple screw pumps in service today. No matter the applications and the environmental conditions, three screw pump is the most flexible pump on the market.

Well known to be very reliable, at reasonable cost, virtually pulsation-free flow, very low acoustic emissions, three screw pumps are extensively used in meeting the requirements of oil & gas, chemical, marine, industrial, mobile, alternative energy, food processing, paper, power gen, pharmaceutical and many other industries.

**SMT16B** three screw pumps represent one of the most used pumps all over the world after thirty five years of experience. **SMT16B** has been designed to reduce the dimensions of the traditional **SMT** series in order to be ideal where reduced dimensions are a must.

### Le pompe a tre viti

*Le pompe a tre viti, oggi, rappresentano la classe di pompe a viti maggiormente utilizzate, indipendentemente dal tipo di applicazione e dalle condizioni ambientali, in quanto sono le più flessibili sul mercato. Sono considerate le più affidabili, a prezzi ragionevoli, e raggiungono bassissimi livelli di emissioni acustiche e assenza di vibrazioni nella trasmissione del flusso. Le pompe a tre viti sono ampiamente utilizzate in quanto rispettano i requisiti di settori quali oil & gas, chimico, navale, mobile, agroalimentare, power generation ed energie alternative, industria della carta, industria farmaceutica e molte altre.*

*Le pompe a tre viti della serie **SMT16B**, sono tra le più usate in tutto il mondo e vantano oltre trent'anni di esperienza. Le pompe **SMT16B** sono state progettate per ridurre gli ingombri, in quanto le dimensioni sono minori rispetto alle tradizionali pompe **SMT**.*

### No pulsation – smooth flow

#### Low noise

**SMT16B** three screw pumps are designed to avoid any pulsation, to ensure a smooth operation and to reduce to the lowest level the acoustic emissions, reducing all costs of second noise reduction measures.

The pulsation-free flow of **SMT16B** pumps, allows Settima screw pumps also in output condition management critical to applications such as precision hydraulic controls and fuel metering.

**SMT16B** pump is a priming pump assembled into a pump body. The three screws rotate inside the pump body and the design of the screws avoids any axial load. The functional pressure develops some tolerance between the balancing piston of the main screw and the surrounding body.

This creates a balancing hydrodynamic force on the screws and, at the same time, lubricates and cools down the sealing ports. The torque needed to move the lateral screws is transmitted hydraulically by the pumped fluid, which means that the screws rotate with no possibilities of wearing.

The geometric design of the three screws creates sealing chambers. During the rotation of the three screws, the main one creates a sort of cavity that holds the fluid and drives it with an axial direction from the inlet to the outlet port.

### Flusso omogeneo – Nessuna pulsazione

#### Basse emissioni acustiche

*Le pompe a tre viti della serie **SMT16B** sono progettate per eliminare le pulsazioni, assicurare un funzionamento omogeneo e ridurre al minimo le emissioni acustiche, riducendo in questo modo i costi legati alla necessità di ricorrere a misure secondarie per la riduzione del rumore.*

*Il flusso privo di pulsazioni delle pompe **SMT16B**, permette l'applicazione delle pompe Settima anche in condizioni critiche, come ad esempio idraulica di precisione, dosaggio e misurazione di carburanti.*

*La **SMT16B** è una pompa di adescamento assemblata in un corpo pompa: le tre viti ruotano all'interno del corpo e la progettazione delle stesse è studiata per evitare qualsiasi carico assiale. A seconda della pressione di funzionamento, si sviluppa una certa tolleranza tra il pistone di bilanciamento della vite e il corpo principale circostante. Questo crea una forza idrodinamica di bilanciamento delle viti e al tempo stesso lubrifica e raffredda le parti di tenuta. La coppia necessaria per muovere le viti laterali è trasmessa idraulicamente dal fluido pompato, questo significa che le viti ruotano senza possibilità di usura. Il profilo geometrico delle tre viti crea camere di tenuta. Durante*

## SMT16B pump series / Serie SMT16B

la rotazione delle viti, la principale crea una sorta di cavità che contiene il fluido e lo spinge con direzione assiale dal condotto di ingresso a quello di uscita.

### SMT16B Applications

**SMT16B** pumps have a very large field of applications. The well proven **SMT16B** technology delivers many different kinds of fluids in a wide variety of demanding industrial applications such as: crude oil transport, power generation, lube and seal oil services, hydraulic elevator, fuel oil transport & burner service, power hydraulics, food, machinery lubrication, commercial marine and Navy, refineries and petrochemical services, chemical processing and more.

**SMT16B** pump is suitable for customization and for special applications such as marine, oil & gas etc.

### SMT16B – Applicazioni

L'affermata tecnologia delle pompe **SMT16B** le rende adatte al trasferimento di diversi tipi di fluidi in varie applicazioni e in molteplici settori industriali, quali ad esempio: crude oil transport, power generation, lubrificazione e seal oil services, ascensori ed elevatori idraulici, fuel oil transport & burner service, idraulica di potenza, industria agroalimentare, lubrificazione macchinari, imbarcazioni commerciali e navale, raffinerie e industria petrolchimica, chimica e molti altri.

Le pompe **SMT16B** possono essere personalizzate e sono adatte a rispondere ai requisiti necessari per applicazioni speciali quali navale, oil & gas ecc.

### SMT16B Fluid handlings

**SMT16B** pumps can handle a large variety of fluids, due to the technology itself. From any kind of oil, mineral and synthetic, to emulsions, high viscosity fuel, petrol, polymer, isocyanates, diesel, liquid food and so on.

### SMT16B Movimento fluidi

Le pompe **SMT16B** sono adatte al trasporto di un'ampia varietà di fluidi, grazie alla loro tecnologia: a partire da qualsiasi tipo di olio, minerale o sintetico, alle emulsioni, ai combustibili ad elevata viscosità, petrolio, polimero, isocianato, diesel, fluidi agroalimentari e molti altri.

### Magnetic coupling sealless leakage free pumps - FGM option

**SMT16B** pump can be equipped with a magnetic coupling if required. The hermetically sealed magnetic coupling is a permanent magnetic synchronous coupling able to transmit torque through magnetic forces between the internal and external rotor. Applying a magnetic coupling, the drive and the driven sides are hermetically separated. In case of critical media the magnetic coupling is a reliable seal and avoids any serious leaking.

The magnetic coupling is the containment shroud that is fixed to the driven sided power unit and separates internal and external rotor from each other. Due to the absence of mechanical connection the vibrations torque transmission are very low, with completely leak-proof separation of product and atmosphere.

The magnetic coupling is used to ensure no media leaking or when working in environments with potentially explosive atmospheres.



### Giunto magnetico senza tenute rotanti assenza di perdite garantita - Opzione FGM

Le pompe **SMT16B** possono, su richiesta, essere dotate di giunto magnetico. Il giunto magnetico permette di sigillare l'accoppiamento che trasmette la coppia tra il rotore interno ed esterno tramite forza magnetica. Con l'applicazione del giunto magnetico, l'elemento di trasmissione e quello condotto sono ermeticamente separati. In caso di fluidi pericolosi, il giunto magnetico garantisce una tenuta affidabile che impedisce perdite. Il giunto magnetico consiste nella copertura fissata sull'elemento condotto che separa il rotore interno da quello esterno. Grazie all'assenza di connessioni meccaniche, le vibrazioni dovute alla trasmissione di potenza sono molto ridotte, senza possibilità di contaminazione dell'atmosfera da parte del fluido e viceversa. Il giunto magnetico è utilizzato per prevenire in modo sicuro perdite in ambienti con atmosfera potenzialmente esplosiva.

## INDUSTRIAL

Lube services  
Power hydraulics (presses, machine tools, working machines rolling mill, dumping equipment, elevators, variable pitch propellers, hydraulic winches)  
Power unit & mini power packs  
Hydraulic governors  
Cooling, heating, recycling  
Driving and filtering  
Process technology and chemistry  
Filtration applications  
Chip conveyors  
Hydro power (turbines & compressor lubrication power)  
Paper & Pulp (lubrication & filtration)  
Gear box lube and filtration system (high viscosity lube, air emulsion)



## POWER GENERATION

Lube oil service  
Control oil service  
Sealing oil service for gas turbine  
Fuel unloading station  
Fuel transfer  
Fuel feeding  
Burner operations service  
Filtration & cooling



## MARINE

Off-line filtration  
Off-line filtration cart and trolleys  
Filtration & oil transfer  
Fuel service  
Lube oil circulation service  
Lubricating liquids (machines, turbines, gear sets, motors)



## OIL & GAS

Oil filtration & cooling  
Oil and fuel oil lubrication  
Oil rigs  
Refineries (transport, meter and mix)  
Off-shore platform  
Petrochemical industry  
Transfer service



## Technical characteristics / Caratteristiche tecniche

<b>Types</b> <i>Tipi</i>	Dry (SMT16B) or submerged (SMIT16B) <i>Esterno (SMT16B) o sommerso (SMIT16B)</i>	
<b>Models</b> <i>Modelli</i>	20 – 25 – 32 – 40 – 45 – 55 – 60 – 70 – 80 – 90 – 110	
<b>Installation</b> <i>Installazione</i>	Free for SMT16B. Submerged (totally or partially) for SMIT16B <i>Qualsiasi per SMT16B. Sommersa (parzialmente o completamente) per SMIT16B</i>	
<b>Flanges</b> <i>Flange</i>	ISO 3019/2	
<b>Connections</b> <i>Conessioni</i>	SAE 3000 - BSPP	
<b>Drive loading</b> <i>Carichi</i>	No axial or radial loads <i>Nessun carico assiale o trasversale</i>	
<b>Shaft rotation</b> <i>Rotazione albero</i>	Clockwise (from shaft end) , (suitable also for counter clockwise rotation) <i>Destra (disponibile anche per rotazione sinistra)</i>	
<b>Shaft speed</b> <i>Velocità di rotazione</i>	From 500 to 3.600 rpm <sup>(1)</sup> <i>Da 500 a 3.600 rpm<sup>(1)</sup></i>	
<b>Flows</b> <i>Portate</i>	From 4 up to 3.200 L/min <i>Da 4 a 3.200 L/min</i>	
<b>Outlet Pressure</b> <i>Pressione di mandata</i>	Up to 40 bar <i>Fino a 40 bar</i>	
<b>Inlet Pressure</b> <i>Pressione in aspirazione</i>	Min. -0.7 bar max. 3 bar <sup>(2)</sup> <i>Min. -0.7 bar max. 3 bar<sup>(2)</sup></i>	
<b>Fluids<sup>(3)</sup></b> <i>Fluidi<sup>(3)</sup></i>	<ul style="list-style-type: none"> <li>• Mineral oil HLP e HVLP</li> <li>• Ecologic fluids HETG, HEPG, HEE</li> <li>• Synthetic fluid or emulsion: HFA oil-water emulsion, HFB water-oil emulsion 40% of volume, HFC water/glycole – water max 35 to 55%, HFDR phosphate ester</li> <li>• Lubrication high viscosity oils</li> <li>• Special synthetic fluid: MIL-H, SKYDROL,</li> <li>• Fuel oil: MGO, MDO, Low sulfur MDO and HFO</li> <li>• DMX (ISO8217), DMA, DMB, DMC, DMZ</li> <li>• Bunker oil, furnace oil, engines oil, heating oil, hydraulics oils DIN 51524</li> </ul>	<ul style="list-style-type: none"> <li>• Oli minerali HLP e HVLP</li> <li>• Fluidi ecologici HETG, HEPG, HEE</li> <li>• Fluidi sintetici o emulsioni: HFA emulsione olio-acqua, HFB emulsione acqua-olio 40% dl volume, HFC acqua/glicole – acqua max 35 to 55%, HFDR phosphate ester</li> <li>• Olio ad alta viscosità per lubrificazione</li> <li>• Fluidi speciali sintetici: MIL-H, SKYDROL,</li> <li>• Fuel oil: MGO, MDO, Basso livello di zolfo MDO e HFO</li> <li>• DMX (ISO8217), DMA, DMB, DMC, DMZ</li> <li>• Bunker oil, furnace oil, olio per motori, heating oil, olio idraulico DIN 51524</li> </ul>
<b>Viscosity</b> <i>Viscosità</i>	From 2 up to 10.000 cSt <sup>(4)</sup> <i>Da 2 fino a 10.000 cSt<sup>(4)</sup></i>	
<b>Seals polymer (shaft, O-ring)</b> <i>Polimero guarnizioni (albero, anello di tenuta)</i>	NBR, FKM, EPDM <sup>(5)</sup>	
<b>Seal type</b> <i>Tipo di guarnizioni</i>	TM, TMK, TMZ, FGM	
<b>Acoustic Emissions</b> <i>Emissioni Acustiche</i>	From 52 up to 68 db(A) at 2.950 rpm value based on ISO 4412 test procedure <i>Da 52 fino a 68 db(A) a 2.950 rpm (ISO 4412 test)</i>	
<b>Pump body</b> <i>Corpo pompa</i>	Extruded aluminum alloy <i>Alluminio estruso</i>	
<b>Pump body (special applications)</b> <i>Corpo pompa (applicazioni speciali)</i>	Cast iron, steel. Hardened steel and stainless steel available on request <i>Ghisa, acciaio. Acciaio temprato e acciaio inox su richiesta.</i>	
<b>Screws</b> <i>Viti</i>	Steel for main screw , idler cast iron <i>Acciaio vite principale, ghisa viti secondarie</i>	
<b>Screws (special applications)</b> <i>Viti (applicazioni speciali)</i>	Core hardened steel screws, surface treated screws <i>Viti in acciaio temprato, viti trattate superficialmente</i>	
<b>Environment temperature</b> <i>Temperatura ambiente</i>	From -50° up to +60°C <i>Da -50° a +60°C</i>	
<b>Hydraulic Temperature</b> <i>Temperatura olio</i>	From -50°C up to +300°C <i>Da -50°C a +300°C</i>	

All data reported by catalogue can change without any notice. I dati presenti nel catalogo possono cambiare senza preavviso.

(1) For shaft speed lower than 1.000 rpm and over 1.800 rpm please contact Settima. Per velocità inferiori a 1.000 rpm e maggiori di 1.800 rpm contattare Settima.

(2) For higher pressure please contact Settima. Per pressioni maggiori contattare Settima.

(3) For request of different fluids please contact Settima. Per l'utilizzo di diversi fluidi contattare Settima.

(4) For level of viscosity lower than 20 cSt and over 320 cSt please contact Settima. Per livelli di viscosità inferiori a 20 cSt e superiori a 320 cSt contattare Settima.

(5) For special seals, contact Settima. Per tenute speciali, contattare Settima.

## Product description / Descrizione prodotto

DIFFERENT COMBINATIONS OF SMT16B PUMP / *DIFFERENTI COMBINAZIONI DELLA POMPA SMT16B*

Flange configurations view / *Configurazioni flangia*

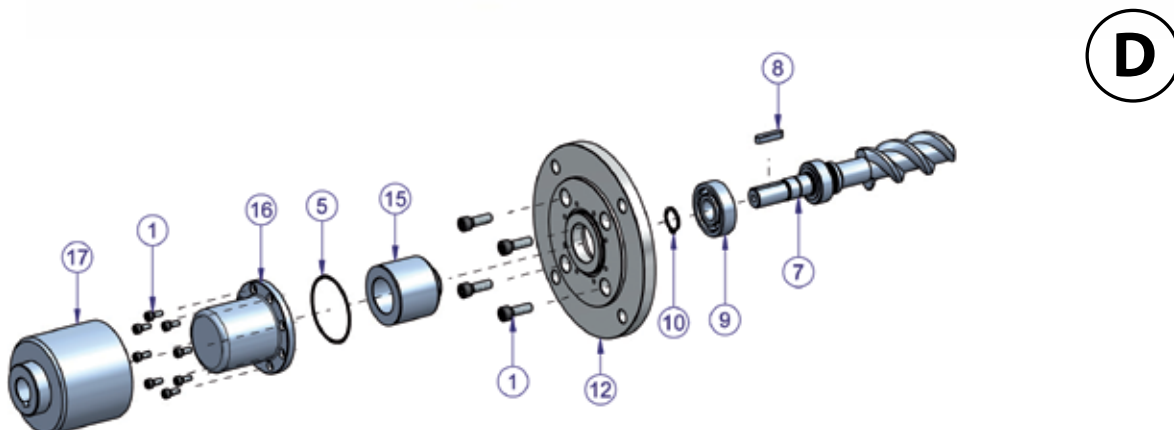
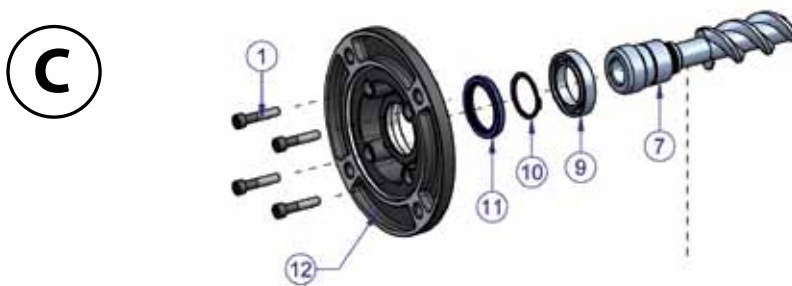
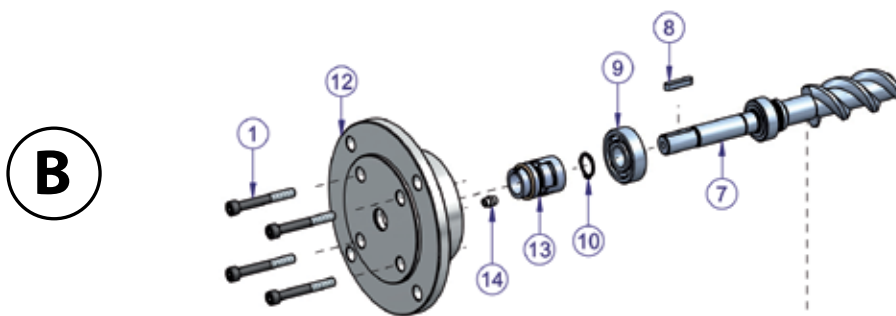
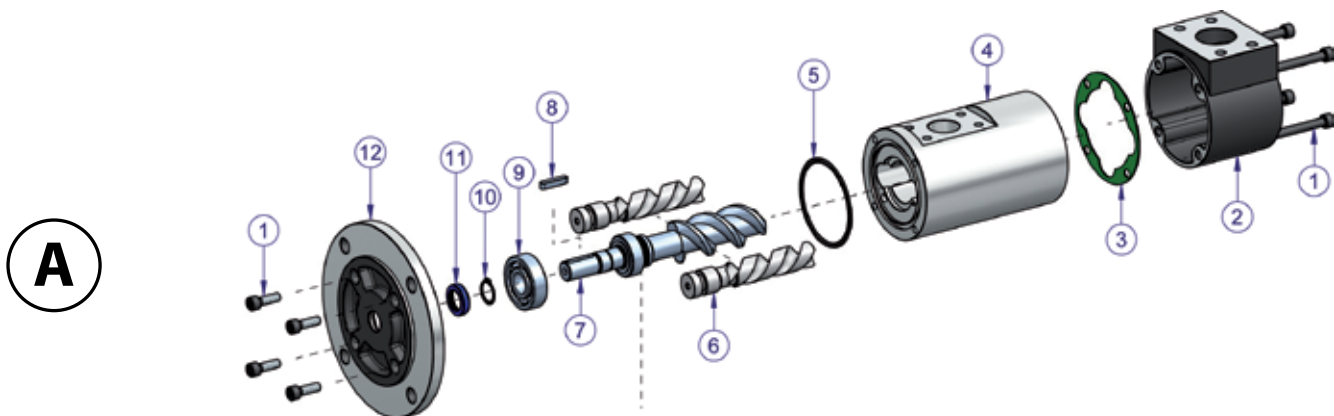

## Product description / Descrizione prodotto

### Shaft and seal options / Opzioni alberi e tenute

N°	Parts description / Descrizione componenti	Material / Materiale
1	Screw / Vite	Common components
2	Radial suction cover / Tappa radiale	Common components
3	Plane gasket / Guarnizione piana	Common components
4	Pump body / Corpo pompa	Common components
5	O-ring / Anello O-ring	Common components
6	Idler screw / Vite laterale	Common components
<b>A</b>	<b>SMT16B (LIP SEAL) / SMT16B (TENUTA A LABBRO)</b>	
7	Main screw / Vite centrale	Common components
8	Key / Linguetta	Common components
9	Ball bearing / Cuscinetto	Common components
10	Seeger	Common components
11	Seal / Anello di tenuta	Common components
12	Flange / Flangia	Common components
1	Screw / Vite	Common components
<b>B</b>	<b>SMT16B (MECHANICAL SEAL) - TM OPTION / SMT16B (TENUTA MECCANICA) - OPZIONE TM</b>	
7	Main screw / Vite centrale	Common components
8	Key / Linguetta	Common components
9	Ball bearing / Cuscinetto	Common components
10	Seeger	Common components
13	Mechanical seal / Tenuta meccanica	Common components
14	Driving oil bushing / Boccola convoglia olio	Common components
12	Flange / Flangia anteriore	Common components
1	Screw / Vite	Common components
<b>C</b>	<b>SMT16B HOLLOW SHAFT (LIP SEAL) / SMT16B ALBERO CAVO (TENUTA A LABBRO)</b>	
7	Main screw / Vite centrale	Common components
9	Ball bearing / Cuscinetto	Common components
10	Seeger	Common components
11	Seal / Anello di tenuta	Common components
12	Flange / Flangia anteriore	Common components
1	Screw / Vite	Common components
<b>D</b>	<b>SMT16B MAGNETIC COUPLING - FGM OPTION / SMT16B GIUNTO MAGNETICO - OPZIONE FGM</b>	
7	Main Screw / Vite centrale	Common components
8	Key / Linguetta	Common components
9	Ball bearing / Cuscinetto	Common components
10	Seeger	Common components
12	Flange / Flangia anteriore	Common components
1	Screw / Vite	Common components
15	Internal rotor MC / Rotore interno MC	Common components
5	O-ring / Anello O-ring	Common components
16	Containment shroud MC / Cappuccio MC	Common components
1	Screw / Vite	Common components
17	External rotor MC / Rotore esterno MC	Common components

## Product description / Descrizione prodotto

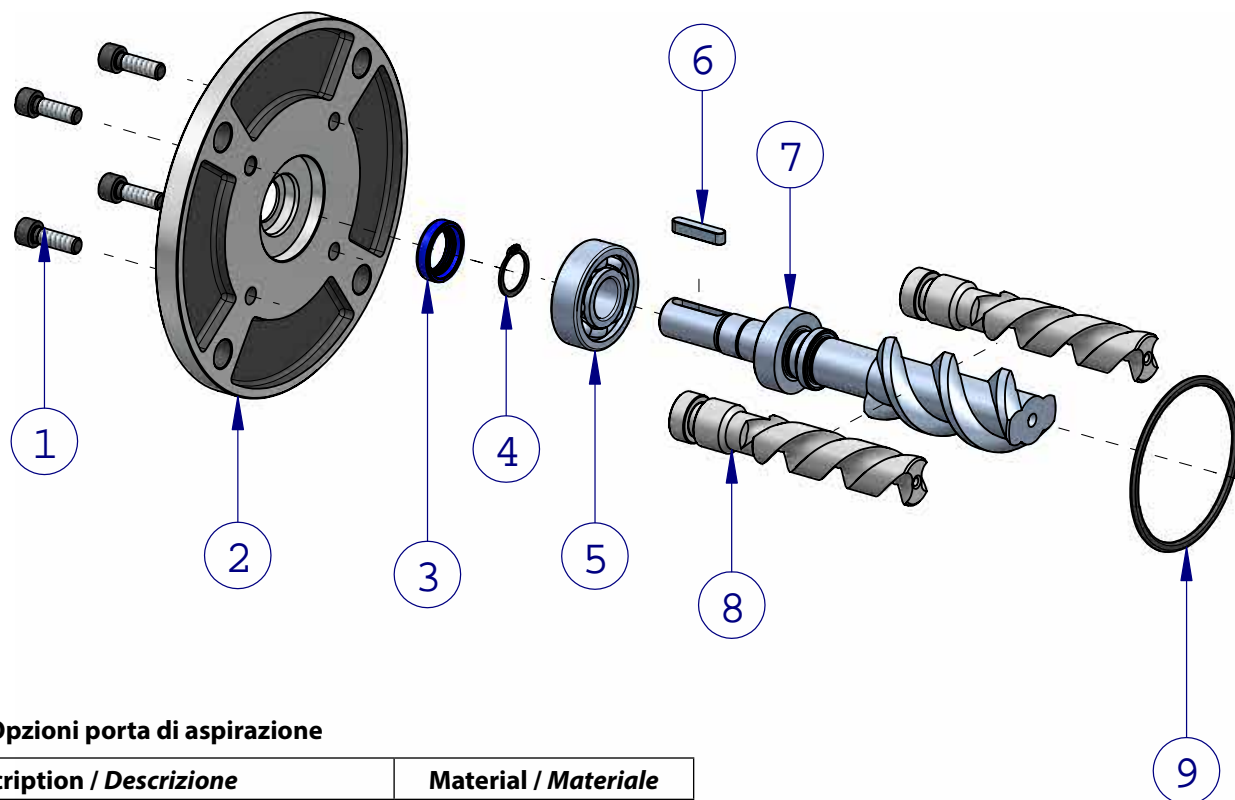

### Suction port options / Opzioni porta di aspirazione

N°	Description / Descrizione	Material / Materiale
1	Screw / Vite	Common components
2	Flange / Flangia anteriore	Common components
3	Seal / Anello di tenuta	Common components
4	Seeger	Common components
5	Ball bearing / Cuscinetto	Common components
6	Key / Linguetta	Common components
7	Main screw / Vite centrale	Common components
8	Idler screw / Vite laterale	Common components
9	O-ring / Anello O-ring	Common components
10	Body pump / Corpo pompa	Common components
11	Plane gasket / Guarnizione piana	Common components
<b>A</b>	<b>SMT16B</b>	
12	Radial suction cover / Tappa radiale	Common components
1	Screw / Vite	Common components
<b>B</b>	<b>SMT16B AX (axial BSPP) / SMT16B AX (assiale BSPP)</b>	
1	Screw / Vite	Common components
12	Axial suction cover / Tappa assiale	Common components
<b>C</b>	<b>SMT16B AL (top flange for vertical installation over the tank) SMT16B AL (tappa aspirazione per installazione verticale sopra serbatoio)</b>	
1	Screw / Vite	Common components
12	Tank top flange / Tappa aspirazione sopra serbatoio	Common components
<b>D</b>	<b>SMT16B (submersible) / SMT16B (sommersa)</b>	
12	Filter / Filtro	Common components
13	Clamp / Fascetta	Common components



# Product description / Descrizione prodotto

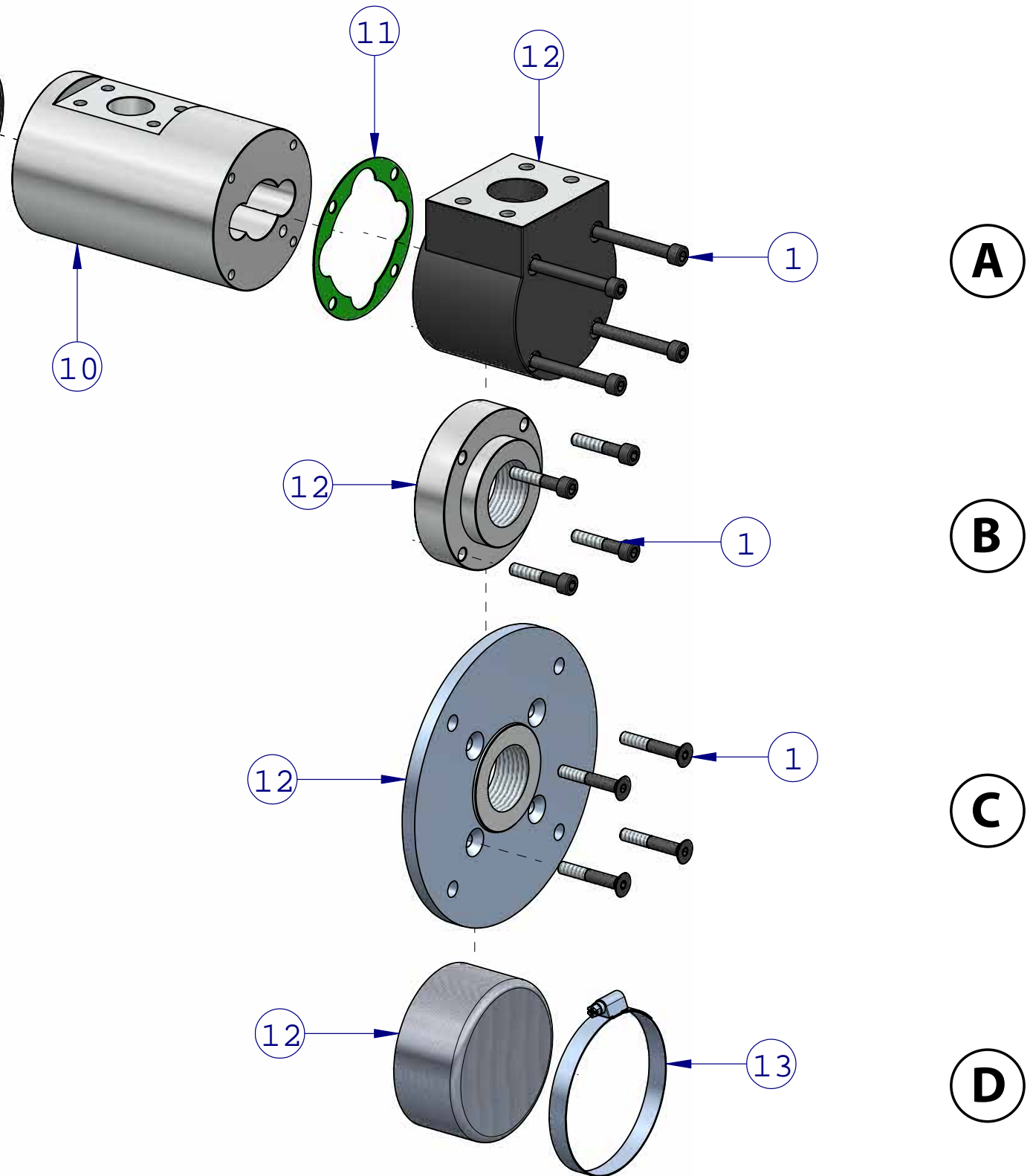

# SMT16B pump - Dimensional drawings / Disegni dimensionali

**SMT16B**

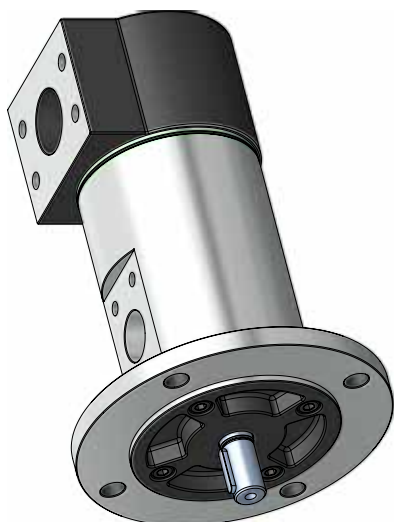

Dry screw pump  
Pompa per uso esterno

**SMIT16B**

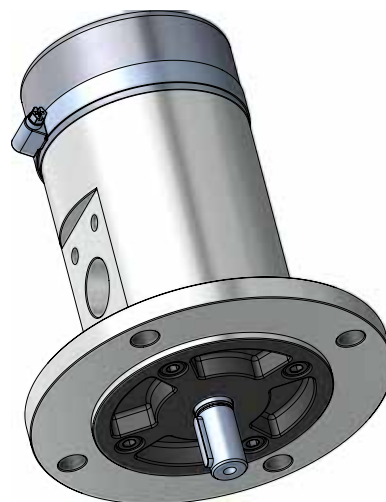

Submersible screw pump  
Pompa per uso sommerso

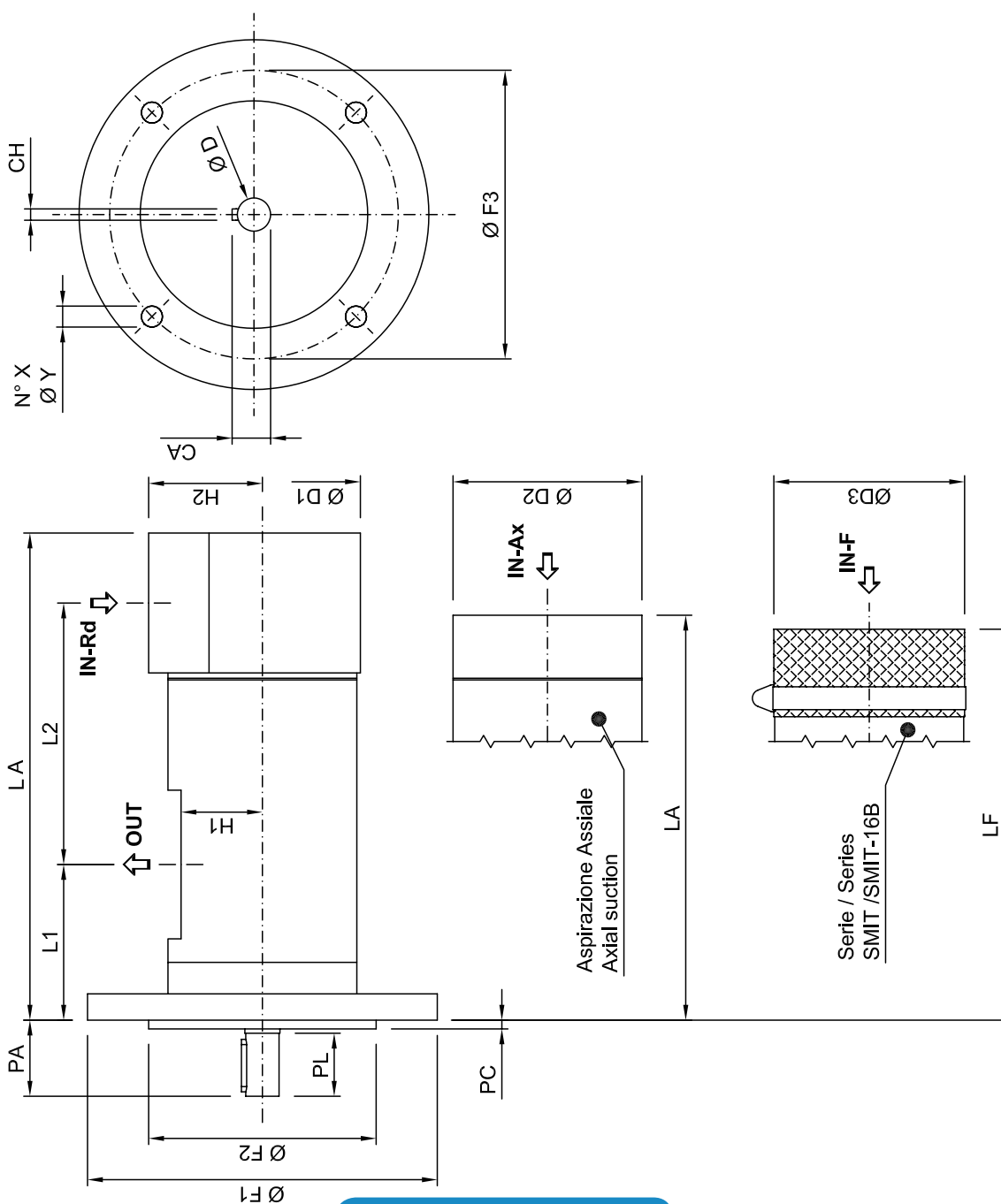

# SMT16B pump - Dimensional drawings / Disegni dimensionali

SMT16B Series/  
Serie SMT 16B

Submersible screw pump/  
Pompa per uso sommerso

SMT16B Series / Serie SMT16B

Dry screw pump / Pompa per uso esterno

Type/Tipologia	Flange / Flangia				Shaft/Albero				Suction / Aspirazione			Discharge / Mandata		Pump / Pompa							
	ØF2	ØY	ØF3	ØF1	PL	ØD	CA	CH	IN-Rd	IN-Ax	H2	OUT	H1	PA	ØD2	L1	L2	LA	Kg	ØD3	LF
GR20 SMT16B 8L-12L-15L-20L	80.0	11.0	103.0	125.0	30.0	14.0	16.0	5.0	½" BSPP	½" BSPP	26.0	½" BSPP	25.0	37.0	59.0	53.0	78.5	134.0	1.5	60.0	133.0
GR25 SMT16B 25L-30L	80.0	11.0	103.0	125.0	36.0	19.0	21.5	6.0	¾" BSPP	¾" BSPP	27.0	½" BSPP	27.5	42.0	65.0	72.5	87.0	178.0	2.7	66.0	158.5
GR32 SMT16B 35L-45L-55L-75L	100.0	11.0	125.0	150.0	35.0	19.0	21.5	6.0	1" SAE - 3000	1" ¼ BSPP	55.0	1" SAE - 3000	41.0	41.0	94.0	61.0	123.0	171.0	4.4	95.0	162.0
GR40 SMT16B 100L-125L-150L	125.0	14.0	160.0	188.0	36.0	19.0	21.5	6.0	1" ½ SAE - 3000	1" ½ BSPP	65.0	1" ¼ SAE - 3000	46.5	42.5	108.0	69.0	149.5	211.5	7	109.0	203.5
GR45 SMT16B 180L-210L	125.0	14.0	160.0	188.0	55.0	32.0	35.0	10.0	2" SAE - 3000	2" BSPP	85.0	1" ½ SAE - 3000	51.5	64.5	122.5	75.4	190.1	258.5	11	123.5	240.5
GR55 SMT16B 250L-300L-330L-380L	160.0	18.0	200.0	235.0	55.0	32.0	35.0	10.0	2" ½ SAE - 3000	2" ½ BSPP	95.0	2" SAE - 3000	55.0	64.5	142.5	83.5	202.5	274.0	15.5	143.5	284.0
GR60 SMT16B 440L-500L	160.0	18.0	200.0	235.0	55.0	32.0	35.0	10.0	3" SAE - 3000	3" BSPP	105.0	2" ½ SAE - 3000	63.0	65.5	155.0	83.5	228.5	292.5	25	154.0	299.5
GR70 SMT16B 600L-660L-800L	200.0	22.0	250.0	300.0	55.0	32.0	35.0	10.0	3" ½ SAE - 3000	3" ½ BSPP	110.0	3" SAE - 3000	73.0	65.5	180.0	94.5	279.0	365.0	30	179.0	379.5
GR80 SMT16B 1.000L-1.200L	200.0	22.0	250.0	300.0	60.0	38.0	41.0	10.0	4" SAE - 3000	4" BSPP	125.0	3" SAE - 3000	83.0	75.0	210.0	150.0	294.5	468.0	47.5	204.0	452.0
GR90 SMT16B 1.220L	200.0	22.0	250.0	300.0	60.0	38.0	41.0	10.0	4" SAE - 3000	4" BSPP	125.0	3" SAE - 3000	83.0	75.0	210.0	150.0	294.5	468.0	51	204.0	452.0
GR90 SMT16B 1.500L-1.700L-2.000L-2.200L	250.0	26.0	300.0	350.0	110.0	55.0	59.0	16.0	5" SAE - 3000	5" BSPP	140.0	4" SAE - 3000	100.0	118.0	250.0	256.0	525.0	816.0	95	251.0	721.0
GR110 SMT16B 2.300L-2.500L-2.800L-3.200L	250.0	26.0	300.0	350.0	110.0	55.0	59.0	16.0	5" SAE - 3000	5" BSPP	140.0	4" SAE - 3000	100.0	118.0	250.0	287.0	489.0	811.0	120	251.0	716.0

All data reported by catalogue can change without any notice. I dati presenti nel catalogo possono cambiare senza preavviso.

# SMT16B AC pump - Dimensional drawings / Disegni dimensionali

**SMT16B AC**



Dry screw pump  
Pompa per uso esterno

**SMIT16B AC**



Submersible screw pump  
Pompa per uso sommerso

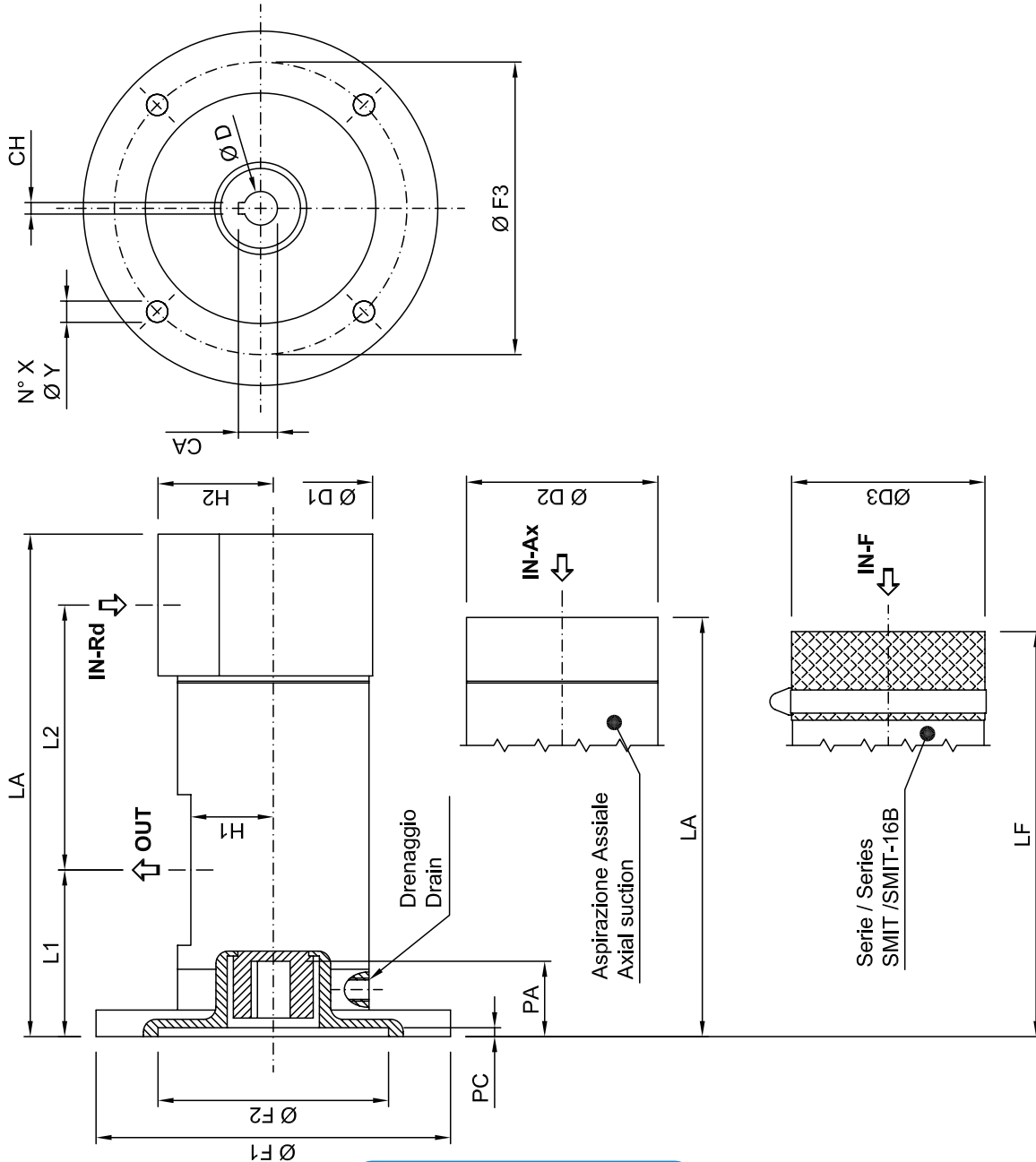

# SMT16B AC pump - Dimensional drawings / Disegni dimensionali

SMT16B AC Series /  
Serie SMT16B AC  
Submersible screw pump /  
Pompa per uso sommerso

SMT16B AC Series / Serie SMT16B AC Dry screw pump / Pompa per uso esterno	Flange/Flangia						Shaft / Albero			Suction / Aspirazione			Discharge / Mandata		Pump / Pompa						
	Type/Typo	ØF2	ØY	ØF3	ØF1	ØD	CA	CH	IN-Rd	IN-AX	H2	OUT	H1	PA	ØD2	L1	L2	LA	Kg	ØD3	LF
GR20 SMT16B AC11 B5 8-12-15-20	95.0	9.0	115.0	140.0	11.0	12.8	4.2	1/2" BSPP	1/2" BSPP	26.0	1/2" BSPP	25.0	25.0	25.0	59.0	57.0	78.5	138.0	1.5	60.0	137.0
GR20 SMT16B AC14 B5 8-12-15-20	110.0	9.5	130.0	160.0	14.0	16.1	5.2	1/2" BSPP	1/2" BSPP	26.0	1/2" BSPP	25.0	33.5	33.5	59.0	56.0	78.5	137.0	1.5	60.0	136.0
GR20 SMT16B AC19 B5 8-12-15-20	130.0	11.0	165.0	200.0	19.0	21.7	6.5	1/2" BSPP	1/2" BSPP	26.0	1/2" BSPP	25.0	42.0	42.0	59.0	75.0	78.5	156.0	1.5	60.0	155.0
GR25 SMT16B AC14 B5 25-30	110.0	9.5	130.0	160.0	14.0	16.2	5.2	3/4" BSPP	3/4" BSPP	27.0	3/4" BSPP	27.5	32.5	32.5	65.0	73.5	87.0	179.0	2.7	66.0	159.5
GR25 SMT16B AC19 B5 25-30	130.0	10.5	165.0	200.0	19.0	21.9	6.5	3/4" BSPP	3/4" BSPP	27.0	3/4" BSPP	27.5	42.5	42.5	65.0	76.5	87.0	182.0	2.7	66.0	162.5
GR32 SMT16B AC19 B5 35-45-55-75	130.0	12.0	165.0	200.0	19.0	21.9	6.5	1" 1/4 SAE -3000	1" 1/4 BSPP	55.0	1" SAE -3000	41.0	43.7	43.7	94.0	84.7	123.0	194.7	4.4	95.0	185.7
GR32 SMT16B AC24 B5 35-45-55-75	130.0	12.0	165.0	200.0	24.0	27.3	8.5	1" 1/4 SAE -3000	1" 1/4 BSPP	55.0	1" SAE -3000	41.0	52.7	52.7	94.0	84.7	123.0	194.7	4.4	95.0	185.7
GR40 SMT16B AC19 B5 100-125-150	130.0	12.0	165.0	200.0	19.0	22.0	6.5	1" 1/2 SAE -3000	1" 1/2 BSPP	65.0	1" 1/4 SAE -3000	46.5	42.5	42.5	108.0	94.0	149.5	236.5	7	109.0	228.5
GR40 SMT16B AC24 B5 100-125-150	130.0	12.0	165.0	200.0	24.0	27.5	8.5	1" 1/2 SAE -3000	1" 1/2 BSPP	65.0	1" 1/4 SAE -3000	46.5	52.5	52.5	108.0	94.0	149.5	236.5	7	109.0	228.5
GR40 SMT16B AC28 B5 100-125-150	180.0	14.0	215.0	250.0	28.0	31.5	8.5	1" 1/2 SAE -3000	1" 1/2 BSPP	65.0	1" 1/4 SAE -3000	46.5	64.0	64.0	108.0	104.5	149.5	247.0	7	109.0	239.0
GR45 SMT16B AC28 B5 180-210	180.0	14.0	215.0	250.0	28.0	31.5	8.5	2" SAE -3000	2" BSPP	85.0	1" 1/2 SAE -3000	51.5	63.5	63.5	122.5	106.4	190.1	289.5	7	123.5	271.5
GR45 SMT16B AC38 B5 180-210	230.0	15.0	265.0	300.0	38.0	42.0	10.5	2" SAE -3000	2" BSPP	85.0	1" 1/2 SAE -3000	51.5	81.0	81.0	122.5	119.9	190.1	303.0	7	123.5	285.0
GR55 SMT16B AC28 B5 250-300-330-380	180.0	14.0	215.0	250.0	28.0	31.5	8.5	2" 1/2 SAE -3000	2" 1/2 BSPP	95.0	2" SAE -3000	55.0	62.5	62.5	142.5	108.5	202.5	299.0	15.5	143.5	309.0
GR55 SMT16B AC38 B5 250-300-330-380	230.0	15.0	265.0	300.0	38.0	42.0	10.5	2" 1/2 SAE -3000	2" 1/2 BSPP	95.0	2" SAE -3000	55.0	82.5	82.5	142.5	128.5	202.5	319.0	15.5	143.5	329.0
GR60 SMT16B AC28 B5 440-500	180.0	14.0	215.0	250.0	28.0	31.5	8.5	3" SAE -3000	3" BSPP	105.0	2" 1/2 SAE -3000	63.0	65.0	65.0	155.0	108.5	228.5	317.5	25	154.0	324.5
GR60 SMT16B AC38 B5 440-500	230.0	14.5	265.0	300.0	38.0	41.8	10.5	3" SAE -3000	3" BSPP	105.0	2" 1/2 SAE -3000	63.0	83.0	83.0	155.0	128.5	228.5	337.5	25	154.0	344.5
GR70 SMT16B AC28 B5 600-660-800	180.0	14.0	215.0	250.0	28.0	31.5	8.5	3" 1/2 SAE -3000	3" 1/2 BSPP	110.0	3" SAE -3000	73.0	63.1	63.1	180.0	118.3	279.0	389.3	30	179.0	403.3
GR70 SMT AC38 B5 600-660-800	230.0	14.5	265.0	300.0	38.0	41.8	10.5	3" 1/2 SAE -3000	3" 1/2 BSPP	110.0	3" SAE -3000	73.0	87.3	87.3	180.0	139.5	279.0	410.5	30	179.0	424.5

All data reported by catalogue can change without any notice. I dati presenti nel catalogo possono cambiare senza preavviso.

## Suction and drain configuration / Configurazioni aspiraz. e drenaggio

Suction and drain hole configuration available as per table below (orientations relative to pressure port).

*Configurazioni di porte di aspirazione, mandata e drenaggio. Vedi tabella sotto.*



### Standard configuration / Configurazioni standard

Standard configuration: T1 – D2

*Configurazione standard: T1 – D2*

Standard configuration for pumps WITH RP VALVE: T4 – D2

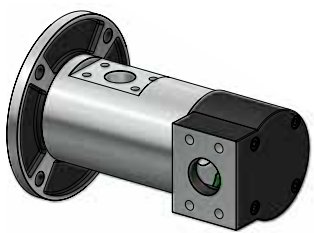
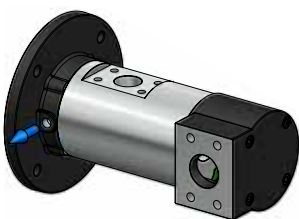
*Configurazione standard per pompa CON VALVOLA RP: T4 – D2*

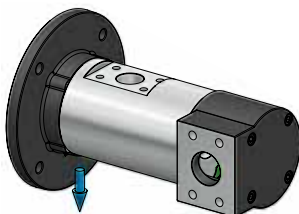
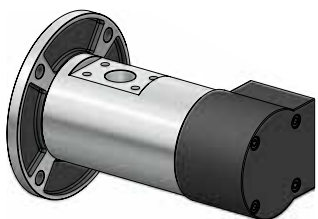
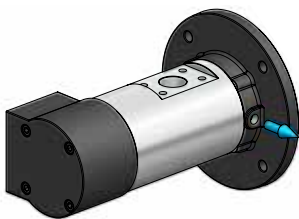
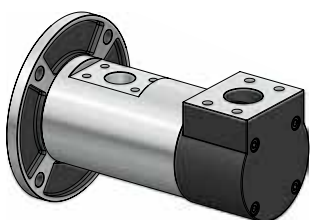
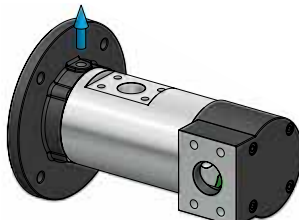
SUCTION CONFIGURATION CODES CODICI CONFIGURAZIONE ASPIRAZIONE	DRAIN CONFIGURATION CODES CODICI CONFIGURAZIONE DRENAGGIO
 <p><b>T1</b></p>	 <p><b>D1</b></p>
 <p><b>T2</b></p>	 <p><b>D2</b></p>
 <p><b>T3</b></p>	 <p><b>D3</b></p>
 <p><b>T4</b></p>	 <p><b>D4</b></p>

Settima recommends that in case of request of pump with RP valve (external variable regulation valve), it is necessary to choose very carefully the suction and drain configuration. Once the external valve is built on the pump it will be not possible any change of both configurations.

*Settima raccomanda di scegliere attentamente la configurazione delle porte nel caso di pompa con valvola RP (valvola regolazione variabile esterna). La valvola RP impedisce di modificare l'orientamento delle porte una volta installata sulla pompa.*

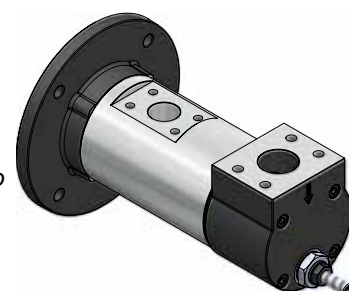

## Motor pump selection / Selezione motore

Please check the table below to select the right motor.

Controllare la tabella per selezionare il motore adatto.

Size	Motor form/ Forma motore	56 AC9	63 AC11	71 AC14	80 AC19	90 AC24	100 AC28	112 AC28	132 AC38
GR 20	B14	✓	✓	✓	✓				
	B5		✓	✓	✓				
GR 25	B14			✓	✓				
	B5			✓	✓				
GR 32	B14				✓	✓			
	B5				✓	✓			
GR40	B14				✓	✓	✓	✓	
	B5				✓	✓	✓	✓	
GR45	B5				✓	✓	✓	✓	✓
GR55	B5						✓	✓	✓
GR60	B5						✓	✓	✓
GR70	B5						✓	✓	✓

All data reported by catalogue can change without any notice. I dati presenti nel catalogo possono cambiare senza preavviso.

GR80, GR90, GR110 are not available with hollow shaft. GR80, GR90, GR110 non sono disponibili con albero cavo.

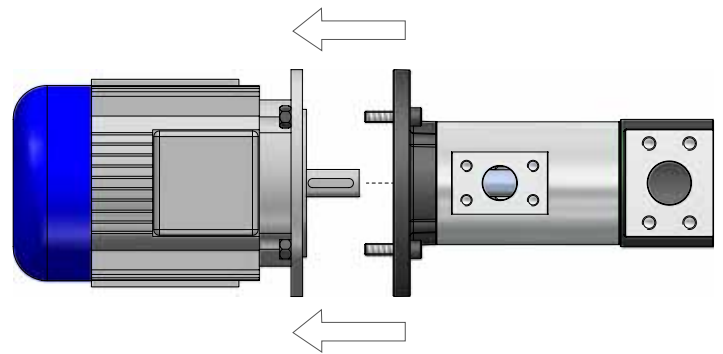
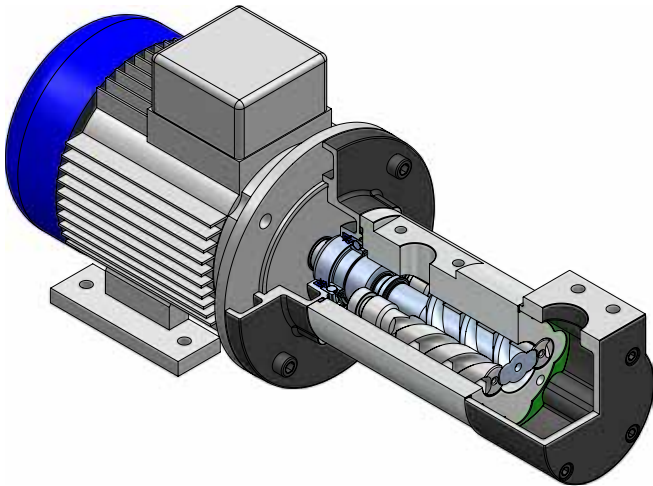

IEC standard motor

# Ordering code table / Tabella codici di ordinazione

Pump type Tipo	Pump model Modello	Nominal flow Portata nominale	High viscosity flag Alta viscosità	Shaft type Tipo albero	Hollow shaft flange Flangia albero cavo	Pump body** Corpo pompa**	Seals polymer (shaft, O-ring) Polimero guarnizioni (albero, anello di tenuta)	Screw treatment Trattamento viti	Seal type Tipo di tenuta	Suction configuration code Codice portata aspirazione	Drain configuration codes (hollow shaft only) Drenaggio (solo AC)	Internal pressure relief valve Valvola interna di sicurezza	Suction flange Flangia d'aspirazione	Rotation Rotazione	Bearing type Tipo cuscinetto
GR20		8L, 12L, 15L, 20L													
GR25		25L, 30L													
GR32		35L, 45L, 55L, 75L	Standard up to/ fino a 100 cSt (none)	Standard normal shaft & flange type albero maschio e flangia (none)				Standard steel main screw cast iron idler screws vite centrale in acciaio viti laterali in ghisa (none)	Standard Lip seal (none)						
GR40		100L, 125L, 150L											Standard radial radiale (none)		
GR45		180L, 210L	Optional S1 (1)			Standard aluminium alluminio (none)	Standard NBR (none)		Optional TM*** mechanical seal for oil	Standard T1 (none)	Standard D2 (none)	Optional RF1 5 bar security sicurezza 5 bar		Standard Clockwise destra (none)	Standard (none)
GR55	SMT16B dry esterna	250L, 300L, 330L, 380L	from/da 100 cSt to/a 250 cSt		B5 B14 (hollow shaft only) (solo AC)			Optional HA*** core hardened steel screws (available only with mechanical seal)	TMK mechani- cal seal for water and glycole and coolant fluids			Optional AXS axial SAE assiale SAE		Optional CS encapsulated ball bearing cuscinetto schermato	
GR60	SMIT16B submersible sommersa	440L, 500L	S2 (1) from/da 250 cSt to/a 500 cSt	Optional hollow shaft type* Albero cavo* AC9 AC11 AC14 AC19 AC24 AC28 AC38		Optional G cast iron ghisa	Optional V FKM			Optional T2 T3 T4	Optional D1 D3 D4	Optional RF2 10 bar security sicurezza 10 bar	Optional AX axial BSPP assiale BSPP	Optional SX counter clockwise sinistra	
GR70		600L, 660L, 800L	S3 (1) from/da 500 cSt to/a 800 cSt			A carbon steel acciaio	E EPDM		TMZ mechanical seal for fuel oil			Optional RF3 15 bar security sicurezza 15 bar	AL tank-top flange tappa d'aspirazione sopra serba- tolo		
GR80		1.000L, 1.200L	S4 (1) over/oltre 800 cSt						FGM magnetic sealless coupling			RP**** variable regulation valve valvola esterna a regolazione variabile			
GR90		1.220L, 1.500L, 1.700L, 2.000L, 2.200L						HD surface treated screws viti trattate superficial- mente							
GR110		2.300L, 2.500L, 2.800L, 3.200L													

\*To request the right hollow shaft according to the pump model please check chapter "Motor pump selection". Per richiedere il giusto tipo di albero cavo in base al modello di pompa vedere il capitolo "Selezione motore".

\*\*Please contact Settima for different available materials and treatments. Contattare Settima per differenti materiali e trattamenti disponibili.

(1) This option may reduce the efficiency of the pump. Questa opzione potrebbe ridurre l'efficienza della pompa.

\*\*\*Options HA and TM are not available for version AC (hollow shaft). Le opzioni HA e TM non sono disponibili per i modelli AC (albero cavo).

\*\*\*\*RP valve is not available for GR80, GR90, GR110. Valvola RP non disponibile per GR80, GR90, GR110.

RP valve not available with options AX and AL. La valvola RP non è disponibile per le opzioni AX e AL.



## Ordering code table / Tabella codici di ordinazione

### Samples application summary / Esempi possibili per applicazioni

Low pressure <sup>(1)</sup> fluid applications <i>Applicazioni fluidi a bassa pressione <sup>(1)</sup></i>	High viscosity configuration <i>Configurazione per elevate viscosità</i>	Body material <i>Materiale corpo</i>	Screw material <i>Materiale viti</i>	Seals <i>Tenute</i>	Bearing type <i>Tipo cuscinetto</i>
Diesel fuel, marine distillate fuel, marine residual fuel, low viscosity fuel oil <i>Diesel, distillati marini, residui, fuel oil a bassa viscosità</i>	-	G	HA	TMK	*
Heavy fuel oil transfer <i>Trasferimento di olio combustibile</i>	S	G	HD	TMK	*
Lube services high viscosity <i>Lubrificazione ad alta viscosità</i>	S	*	*	*/TM	*
Water glycolic emulsion (low % of water <sup>(1)</sup> ) <i>Emulsioni acqua-glicole (bassa % di acqua <sup>(1)</sup>)</i>	-	G	HA	TMZ	CS

All data reported by catalogue can change without any notice. *I dati presenti nel catalogo possono cambiare senza preavviso.*

<sup>(1)</sup> Contact Settima for high pressure applications. *Contattare Settima per applicazioni ad alta pressione.*

\*Standard configuration and material. *Configurazione e materiali standard.*

### Example of codes normal shaft / Esempi di codici albero maschio:

GR60 SMT16B 440L G HD V

### Example of codes for hollow shaft models / Esempi di codici per modelli ad albero cavo:

GR 40 SMT16B 125L AC24 B14

# Performances @ 1500 - GR 20-25

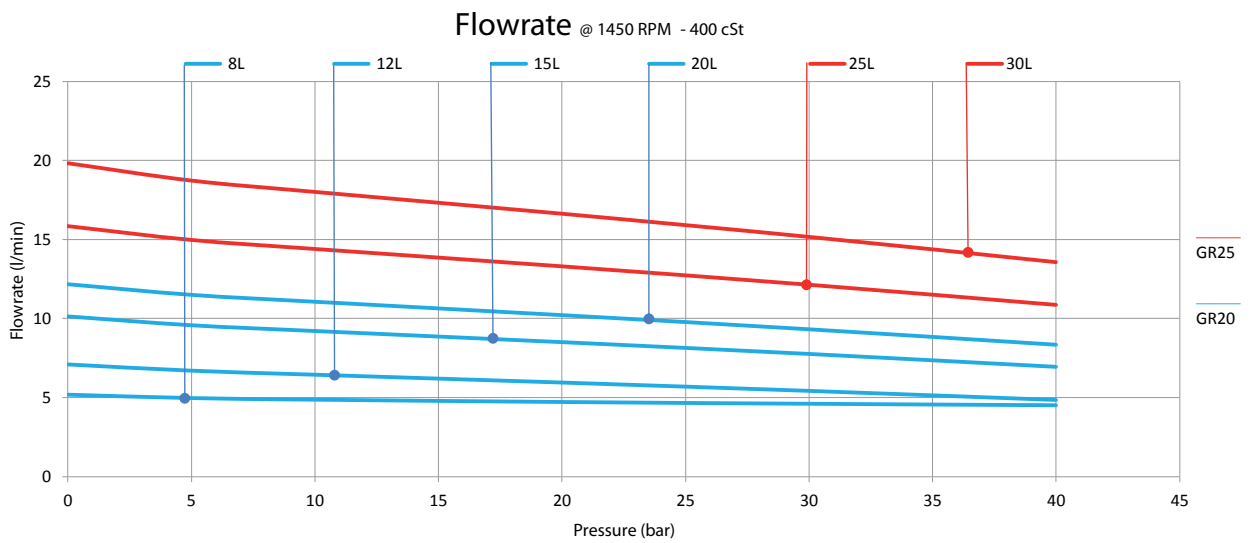
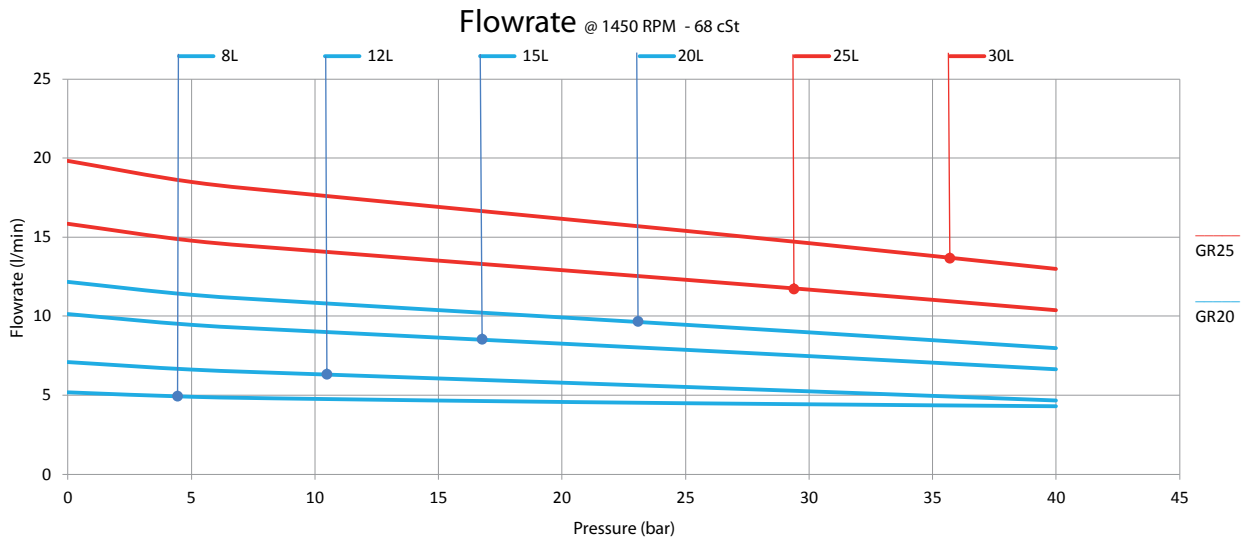
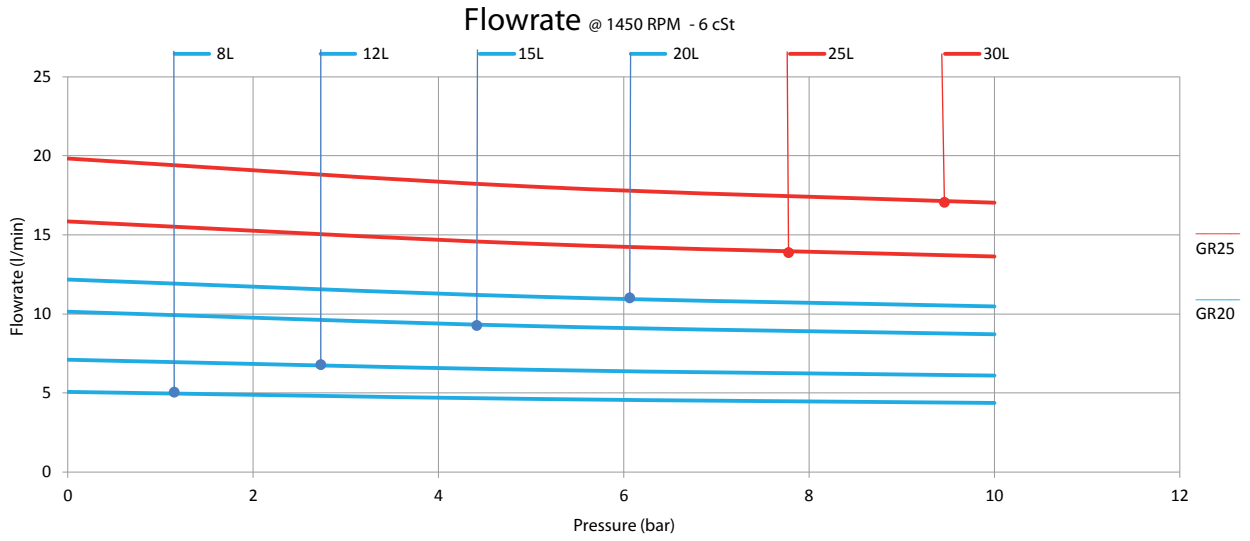

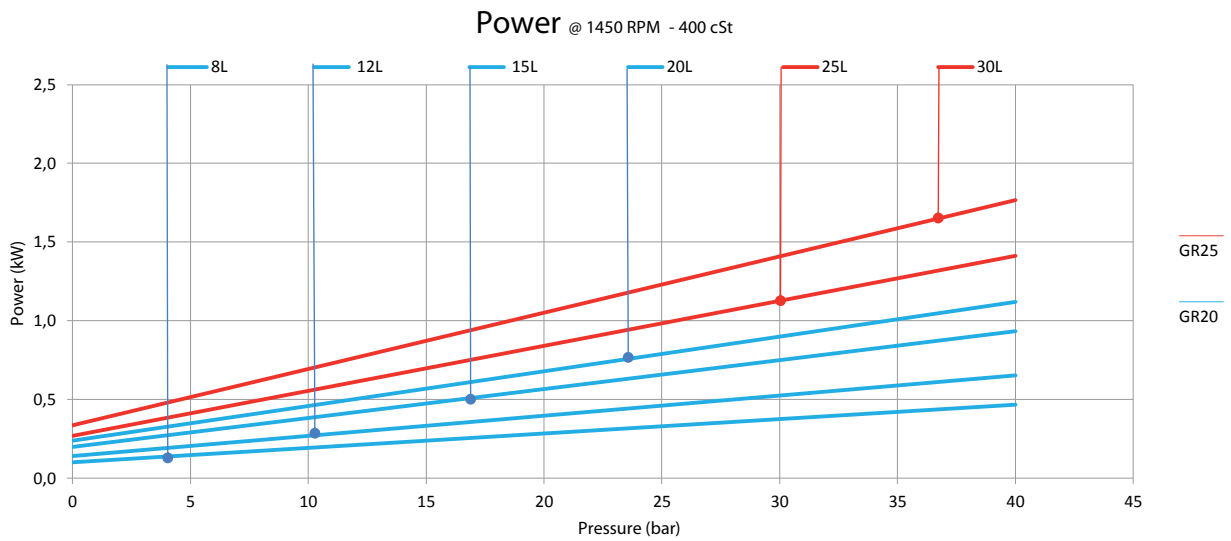
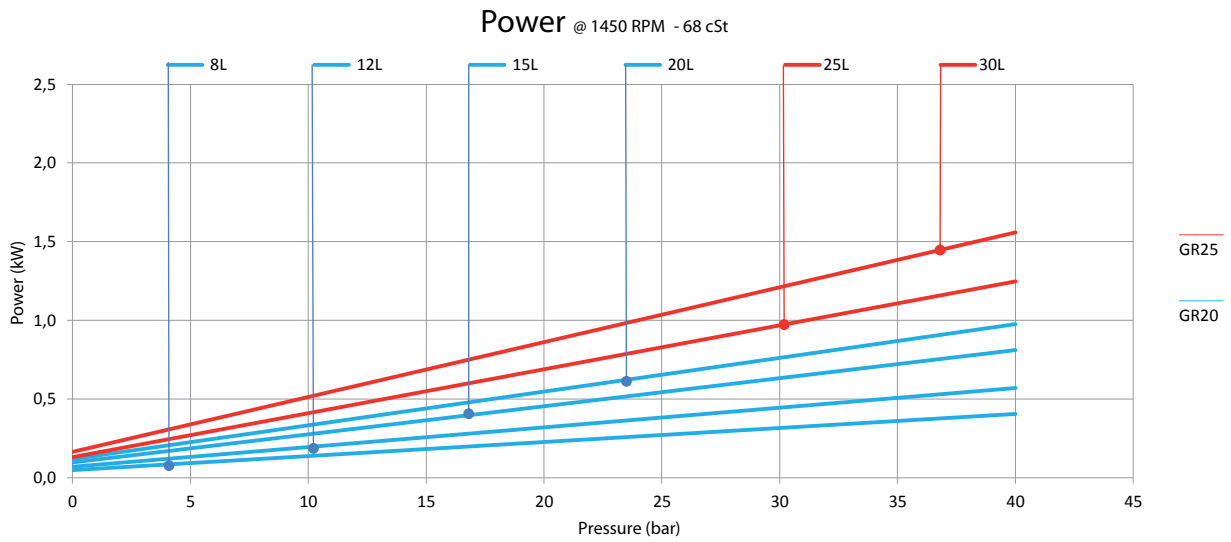
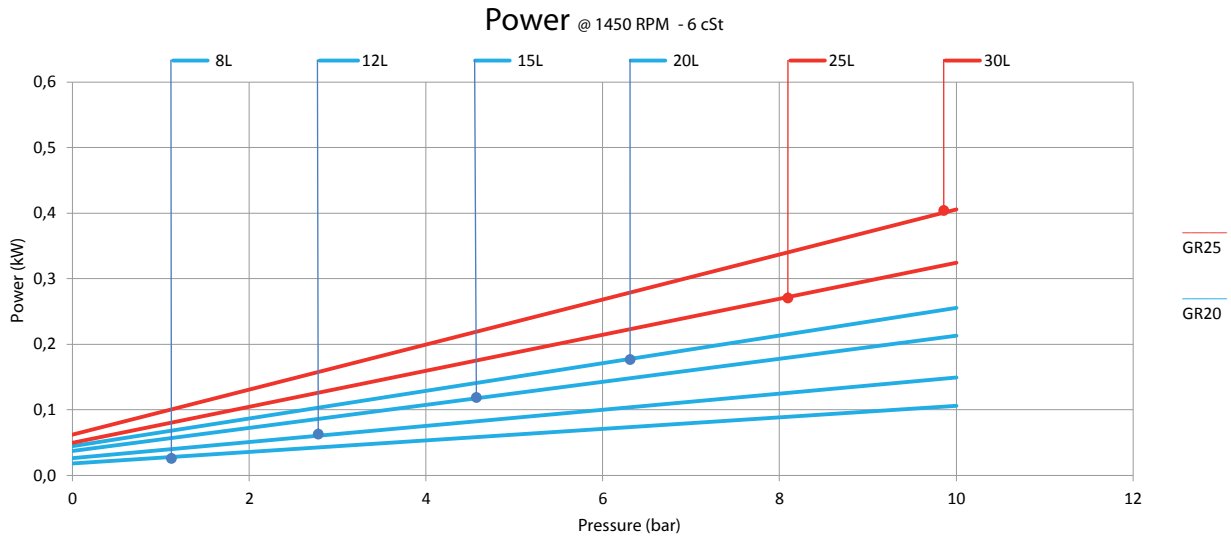

# Performances @ 3000 - GR 20-25

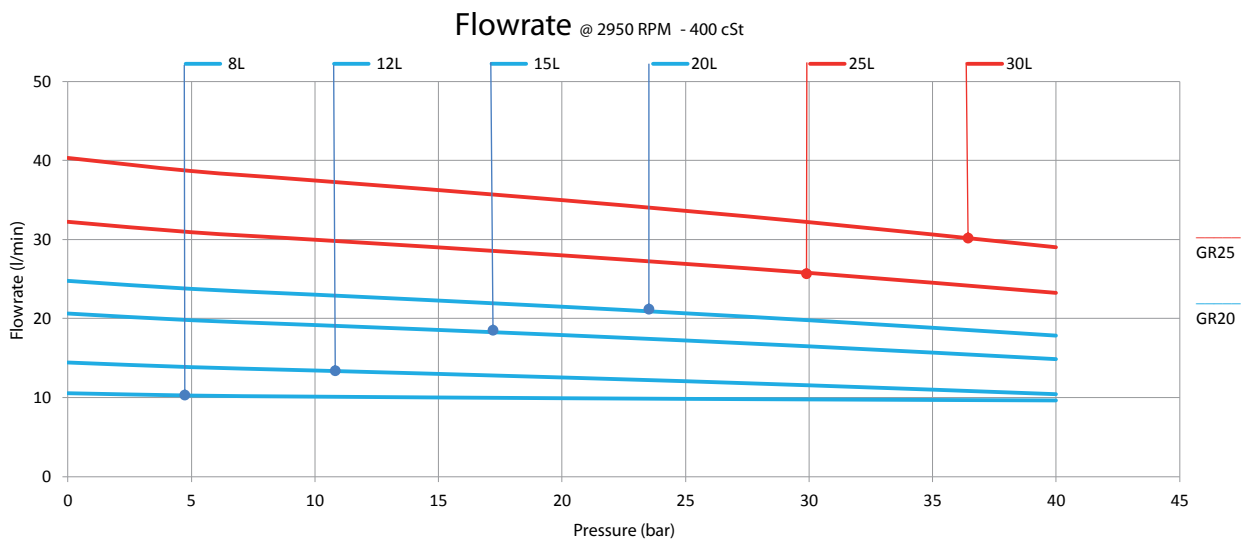
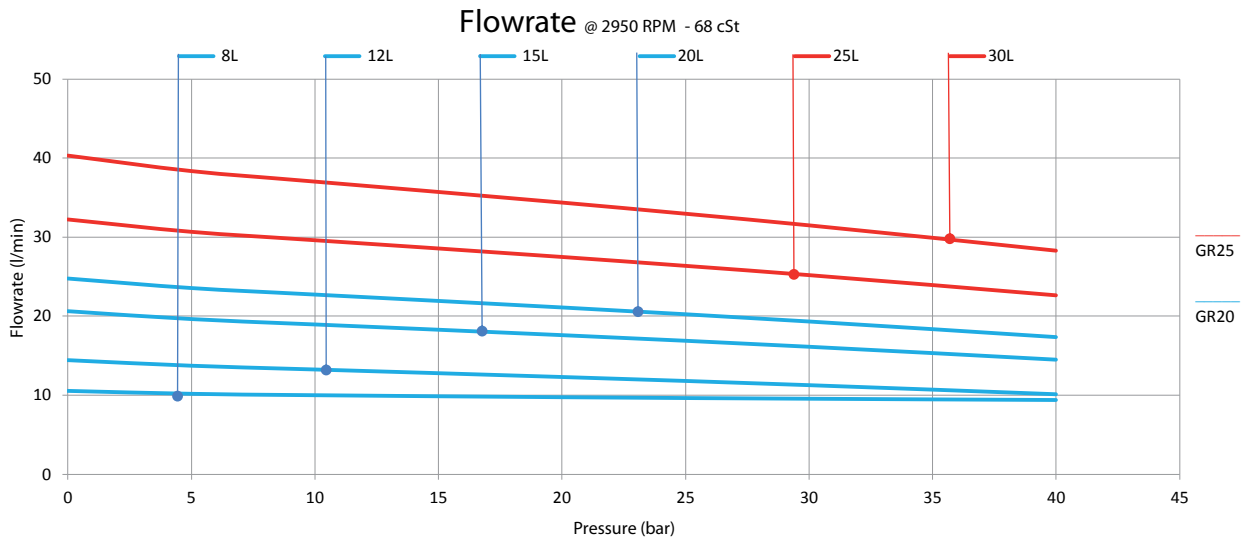
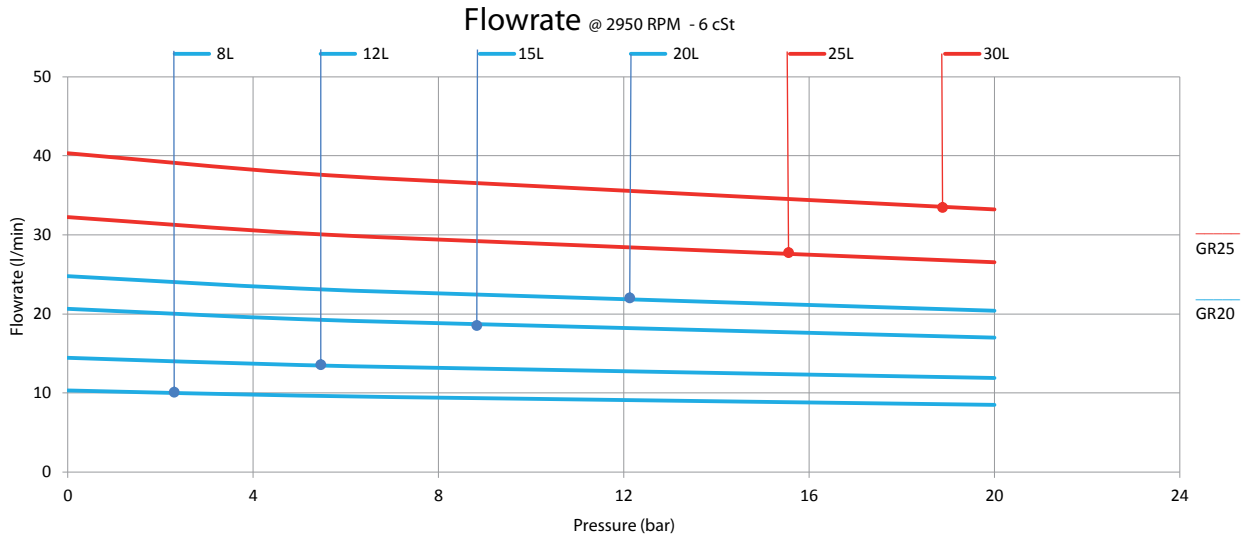

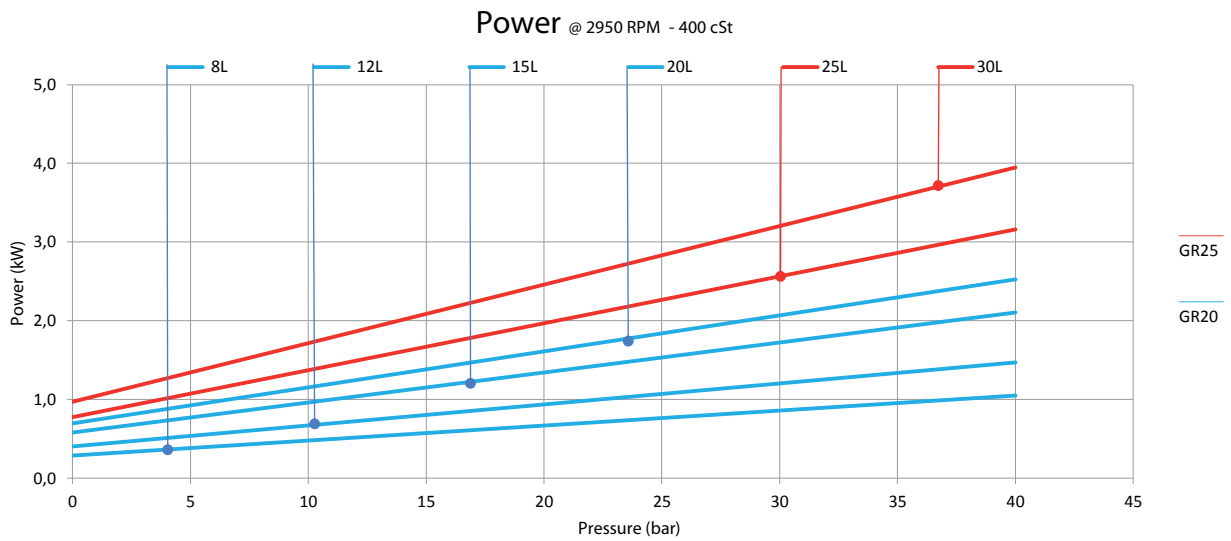
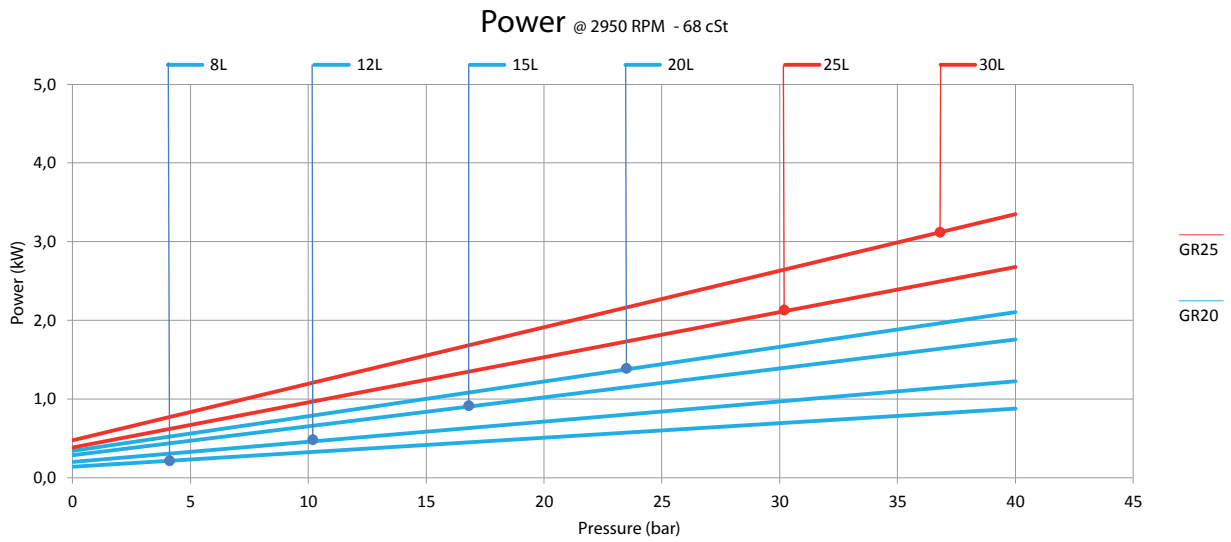
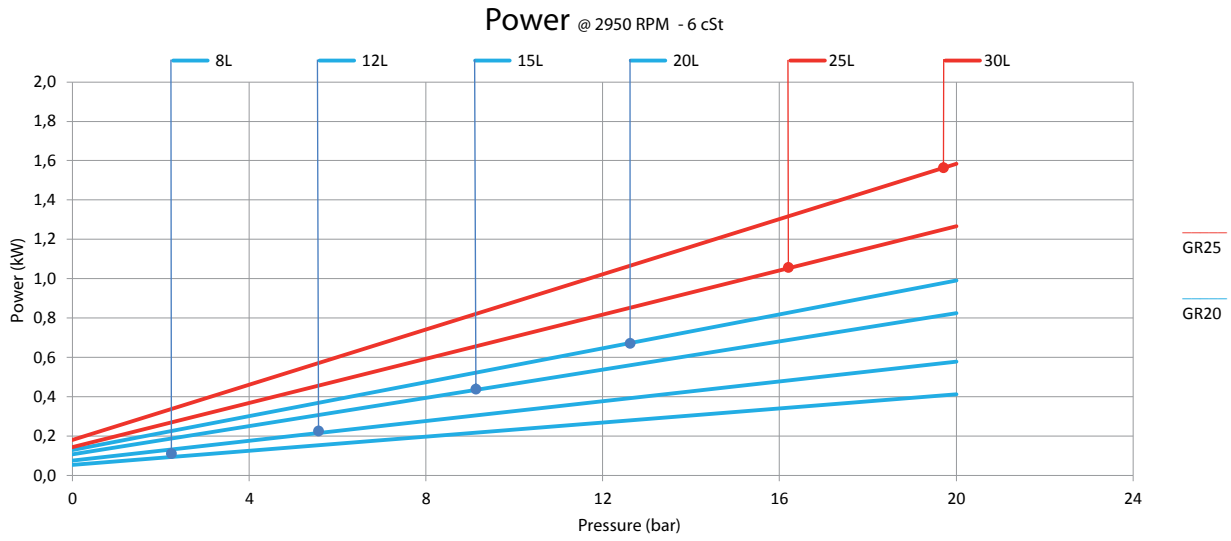

# Performances @ 1500 - GR 32-40-45

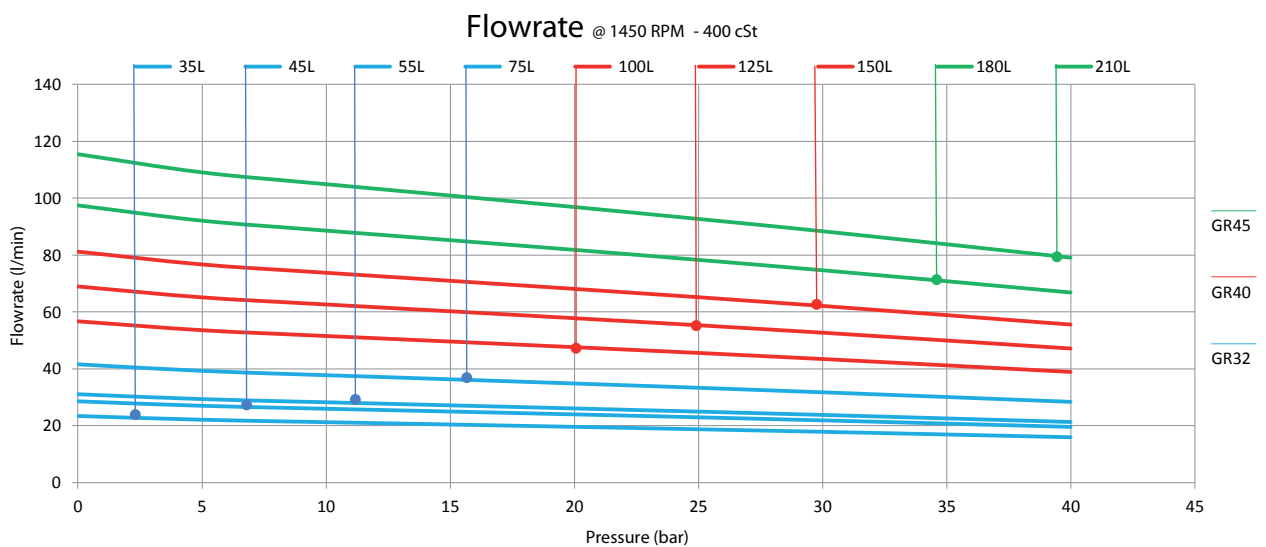
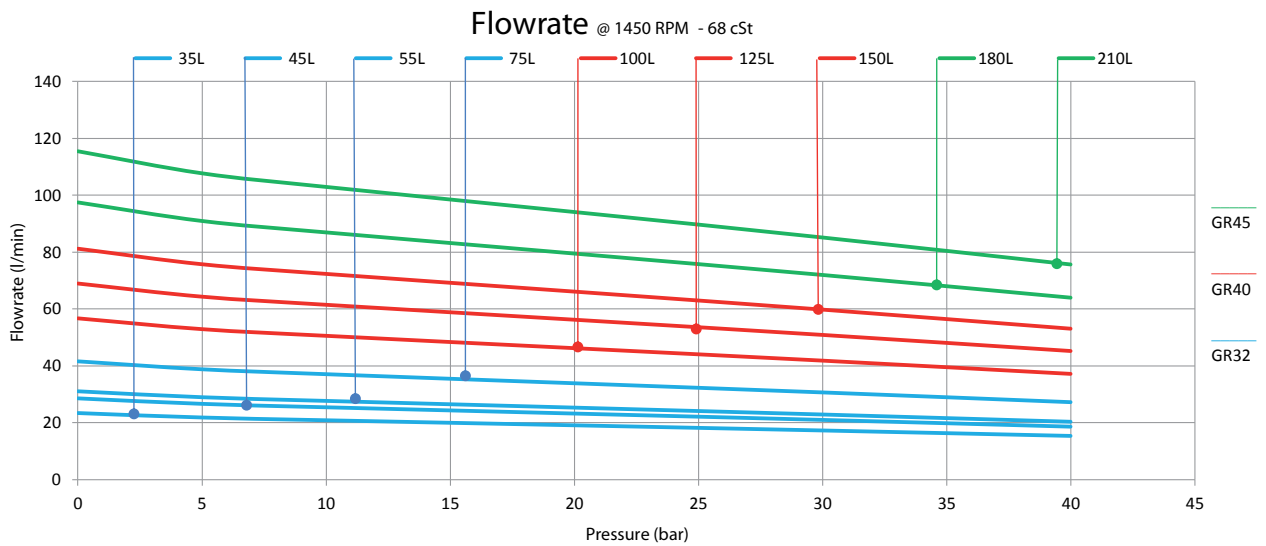
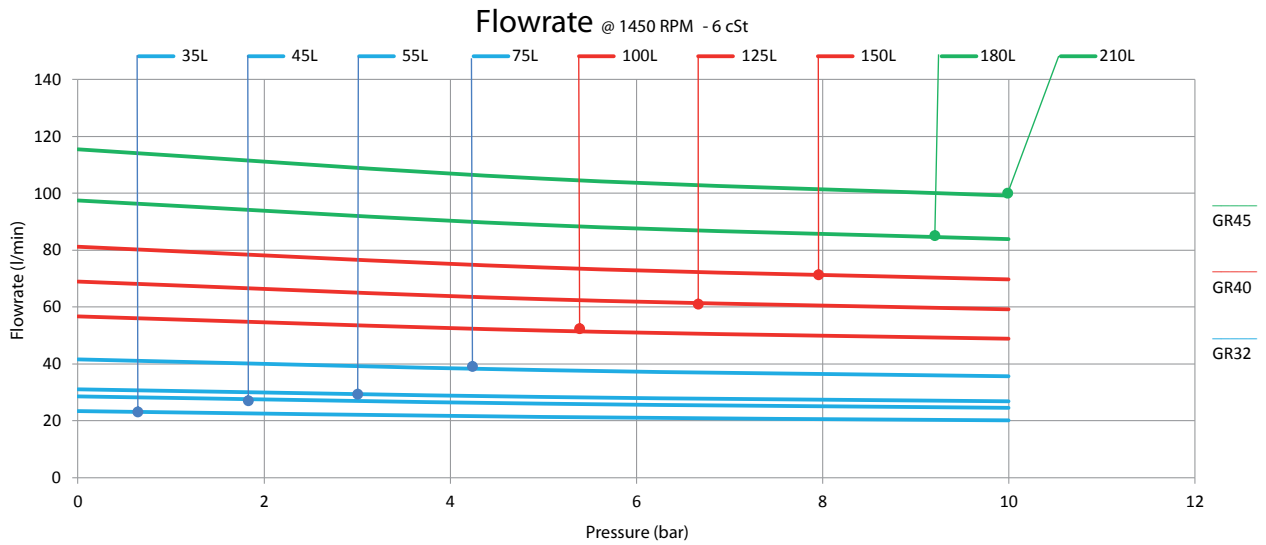

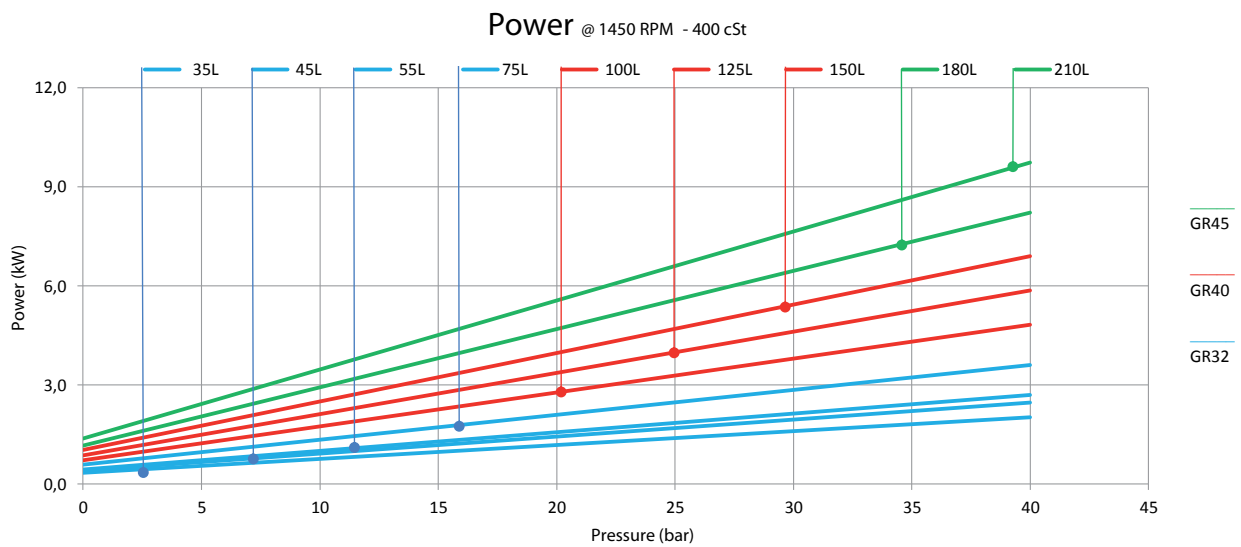
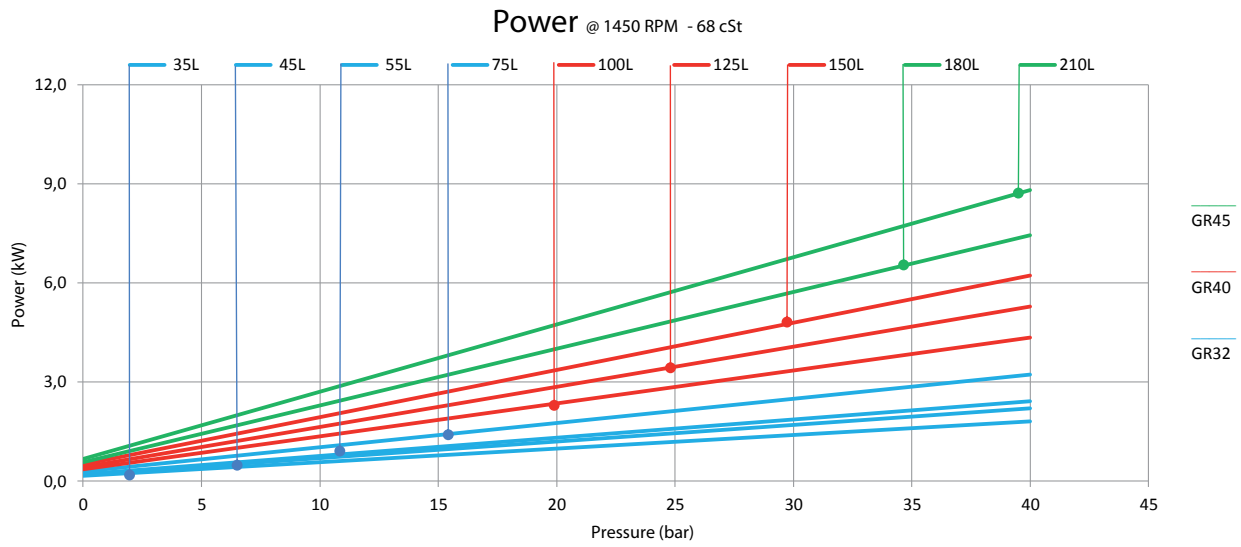
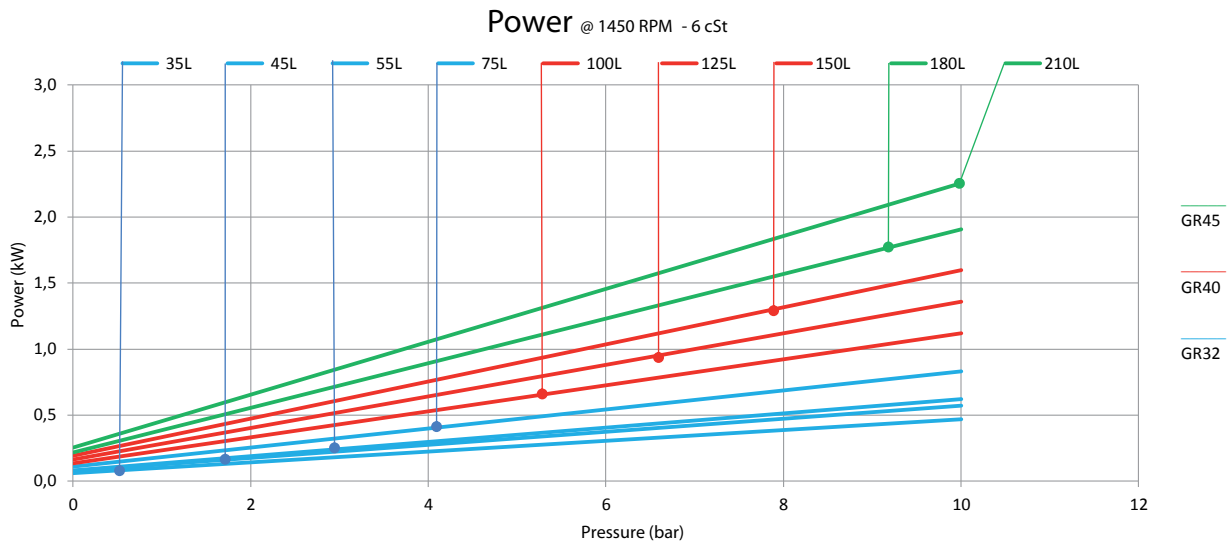

# Performances @ 3000 - GR 32-40-45

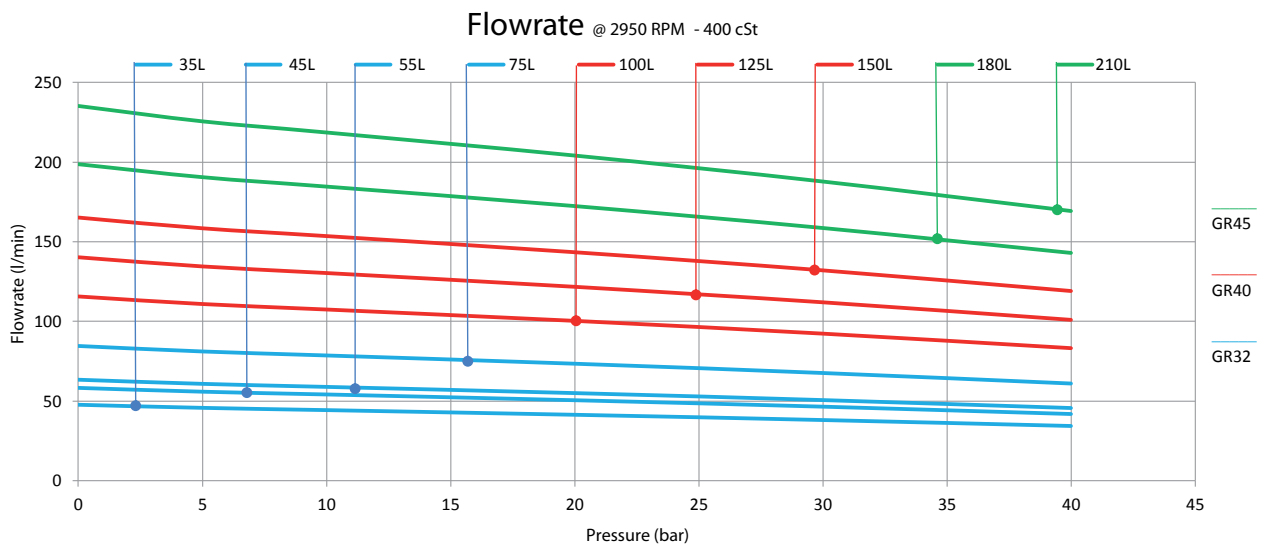
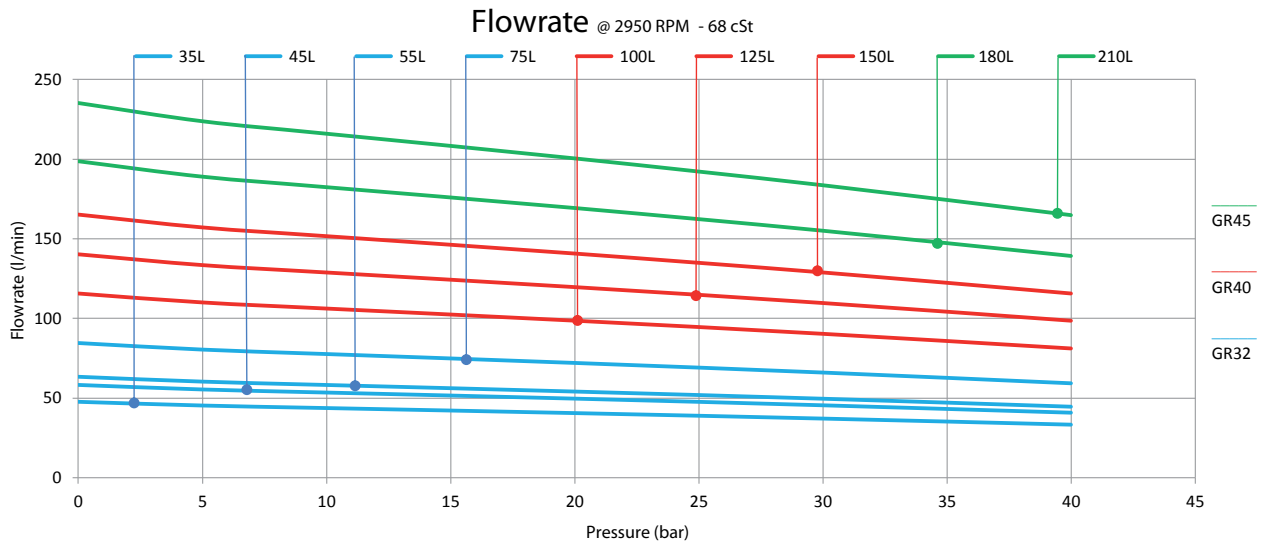
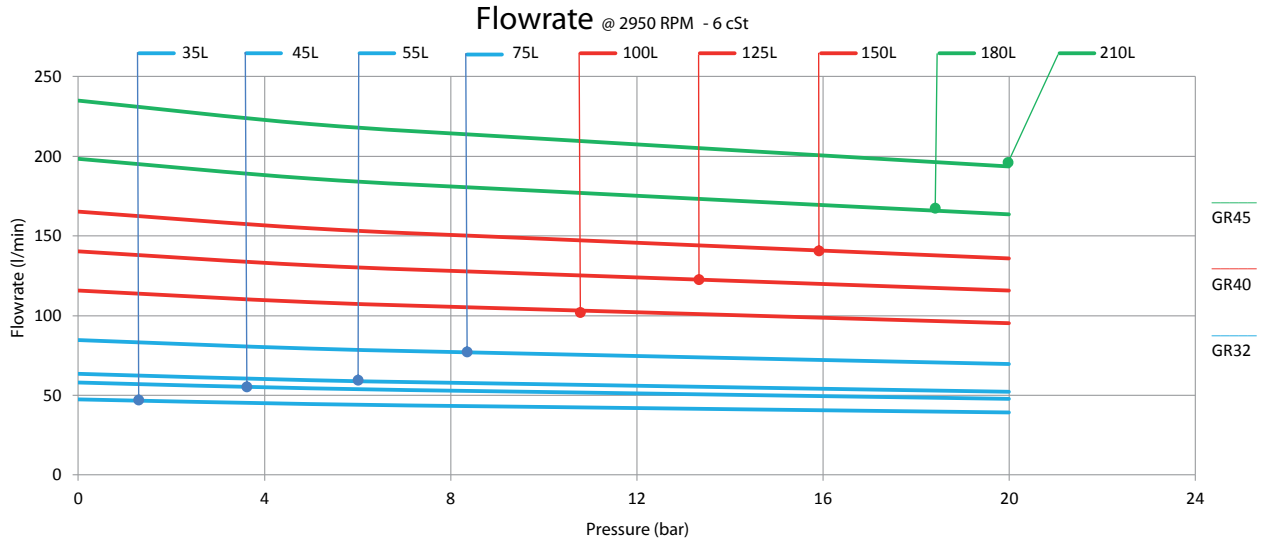



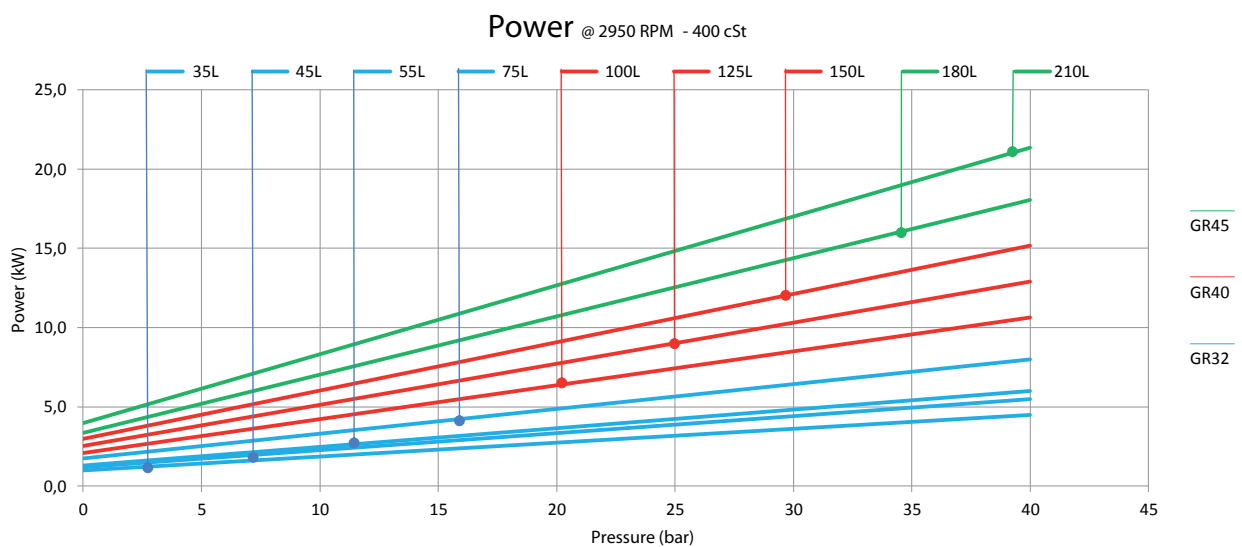
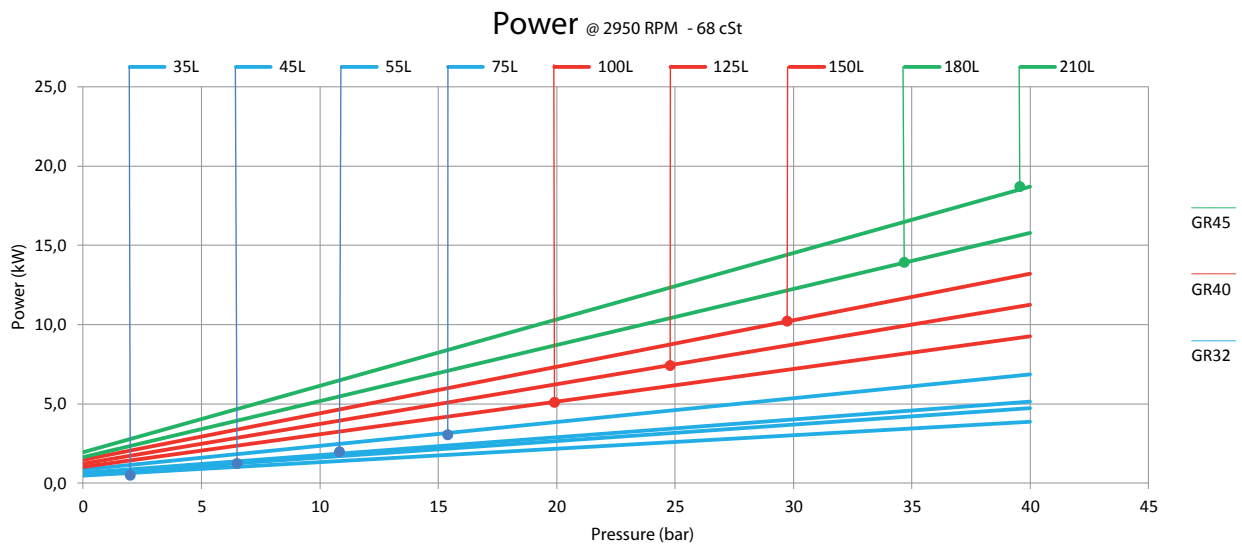
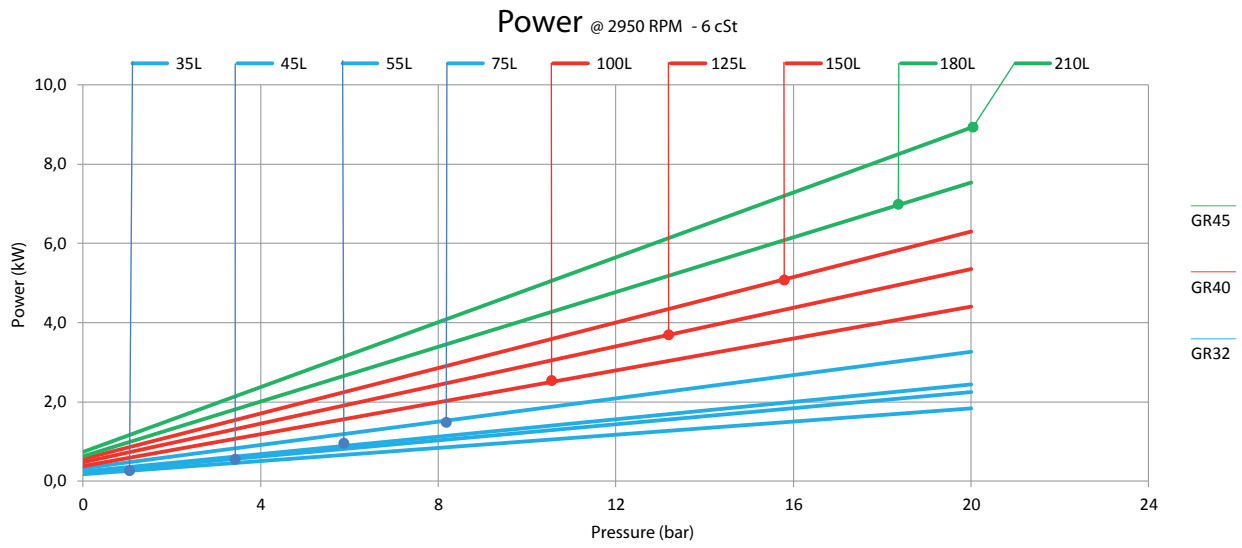

# Performances @ 1500 - GR 55-60-70

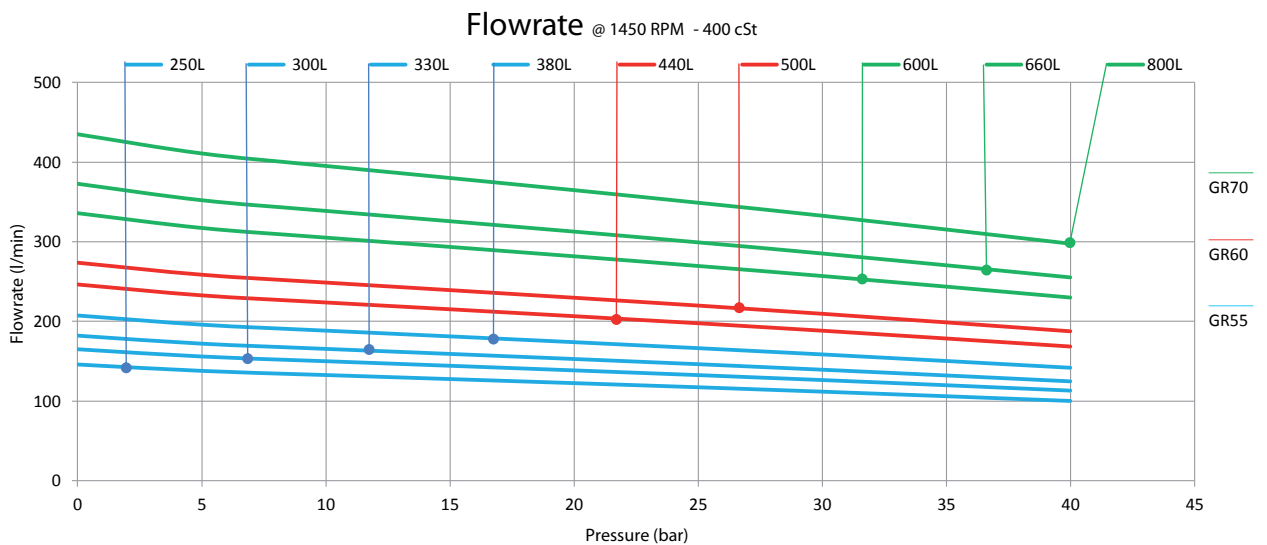
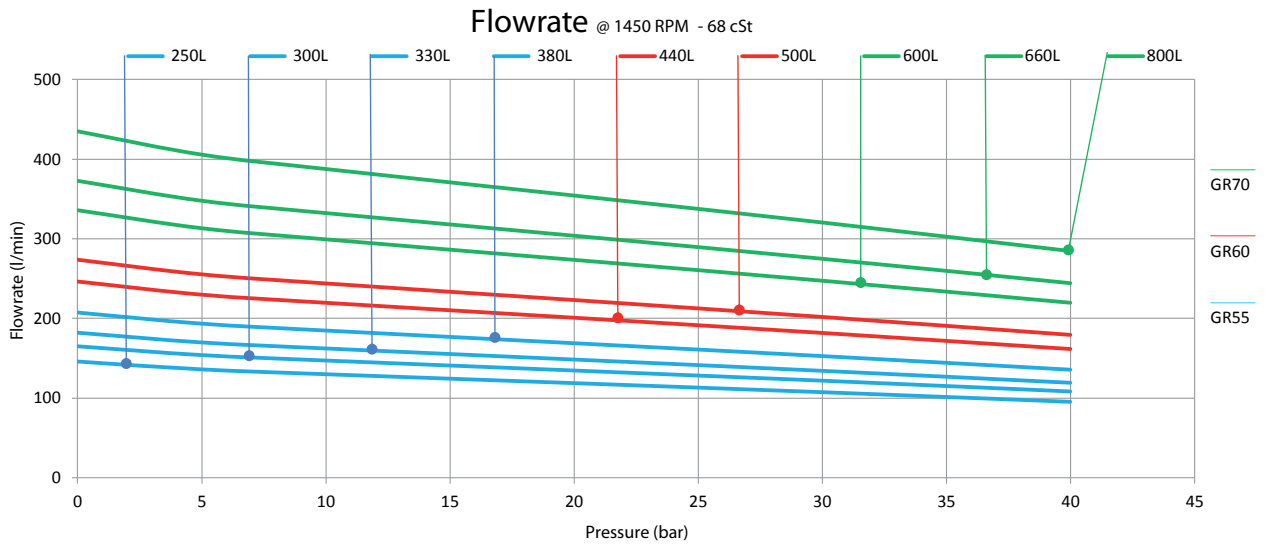
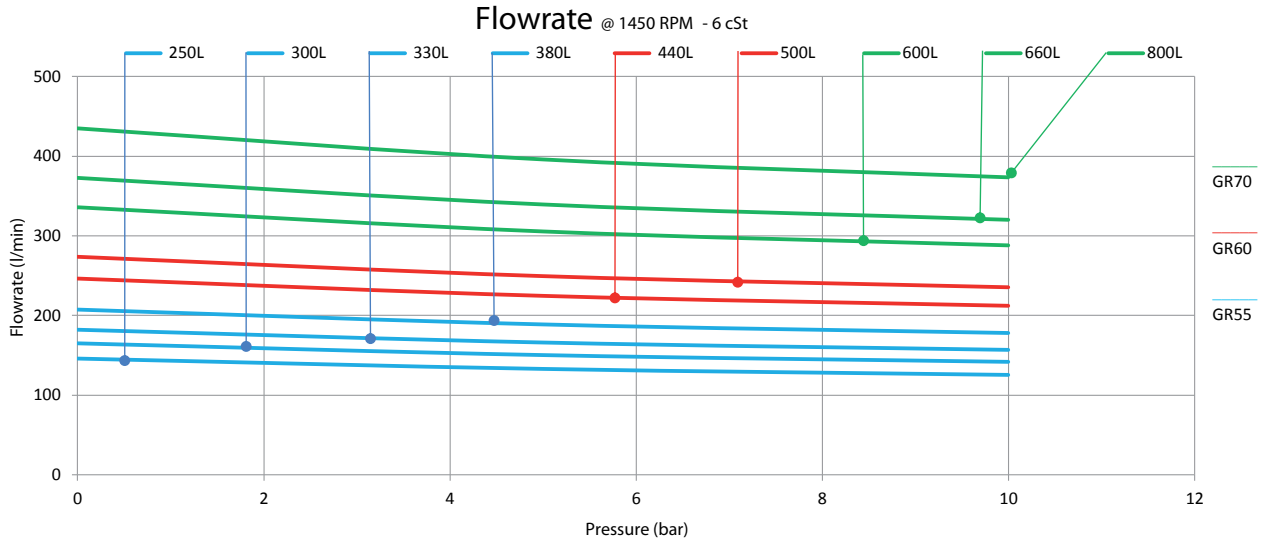

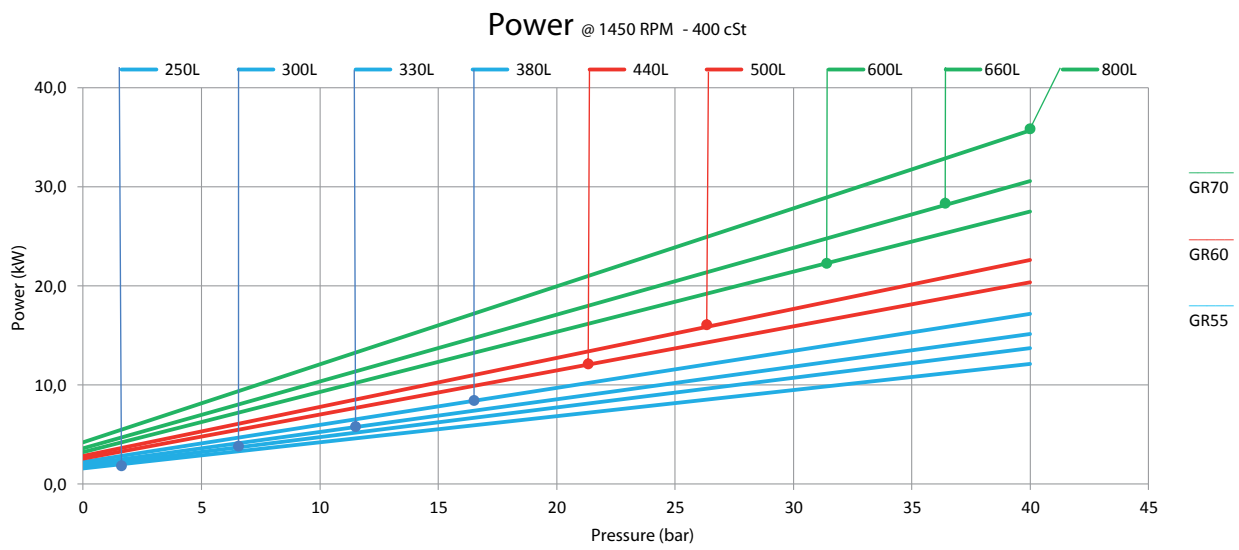
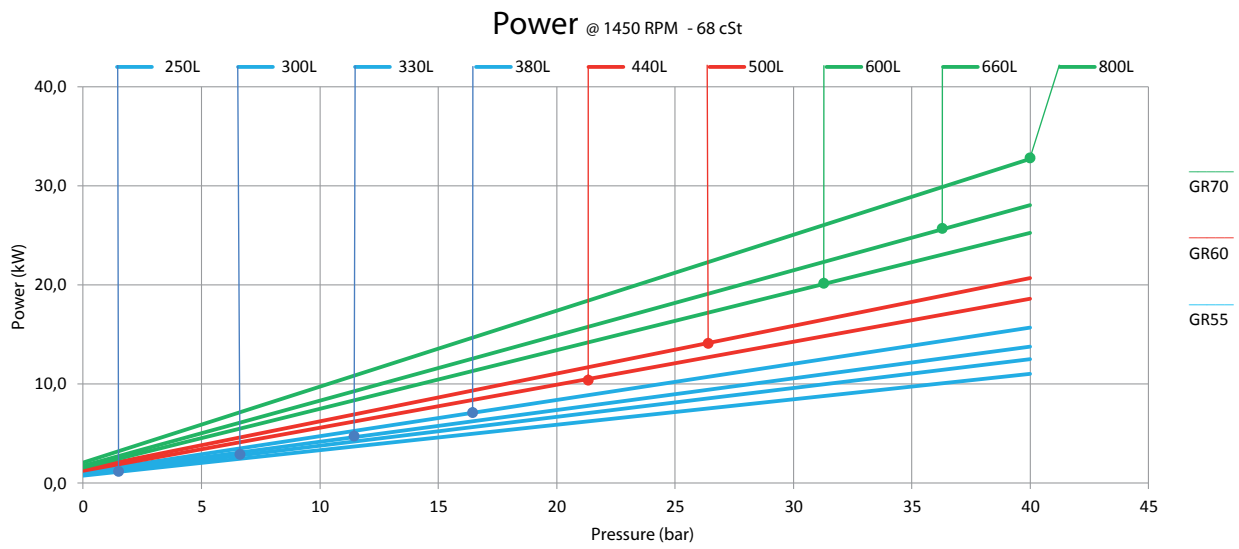
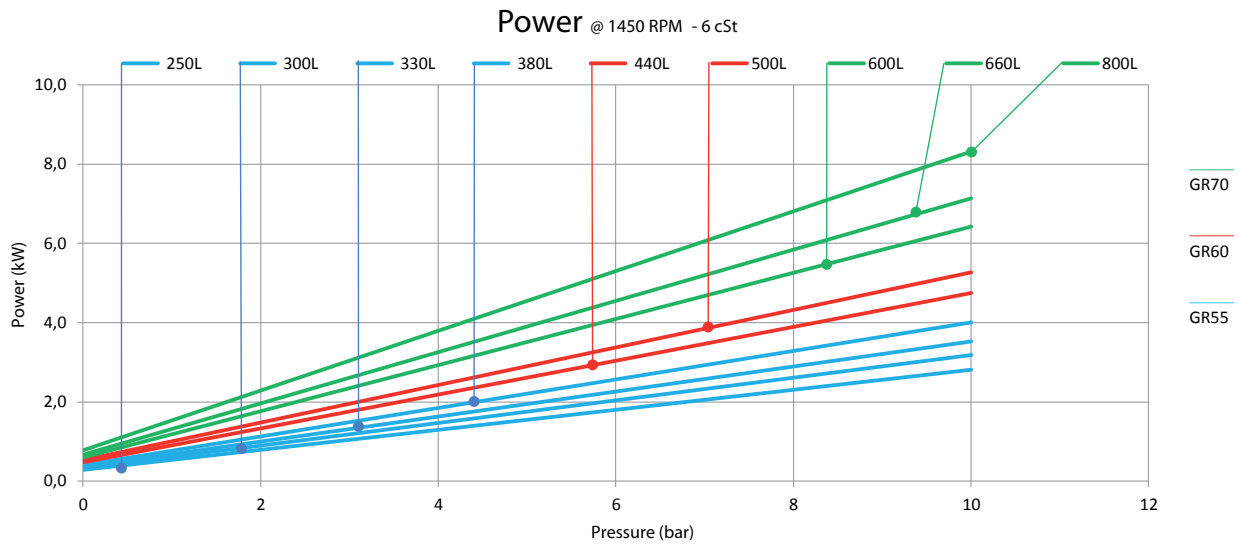

# Performances @ 3000 - GR 55-60-70

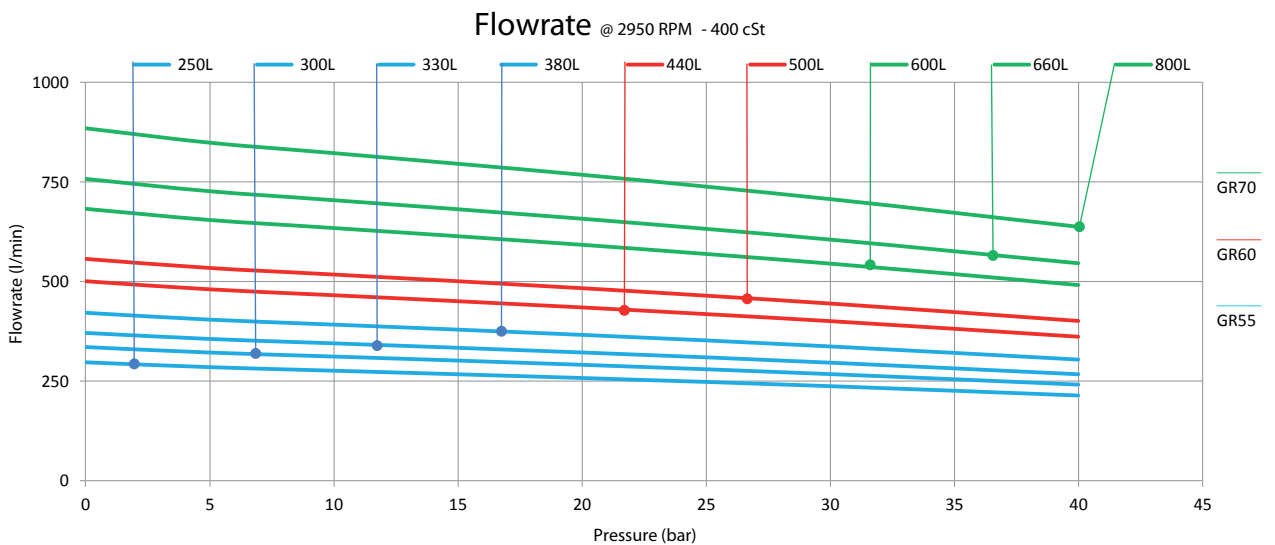
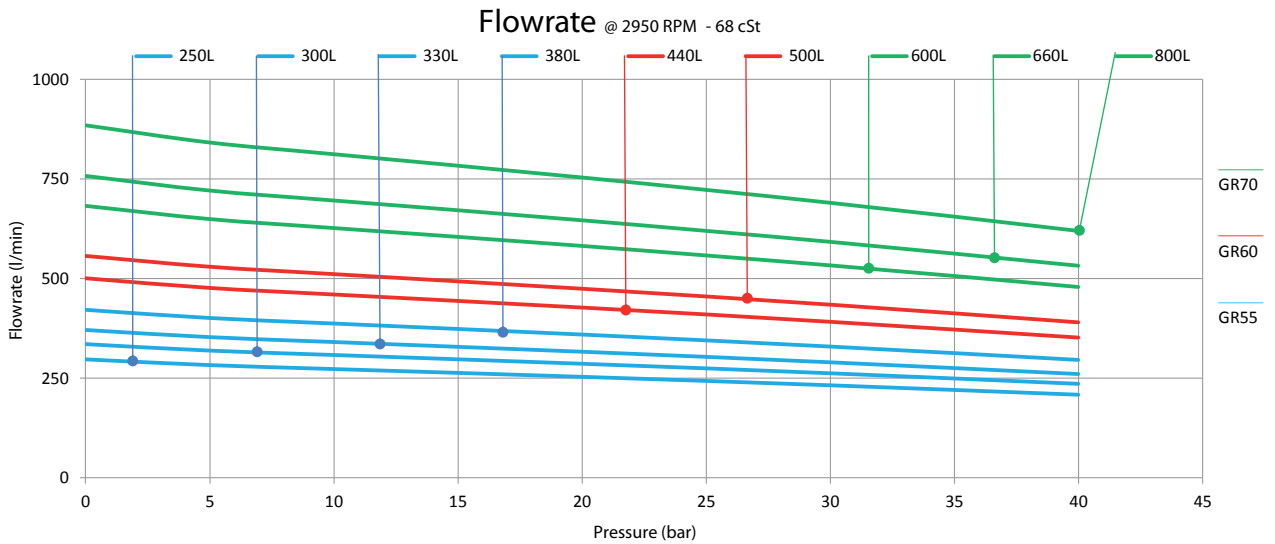
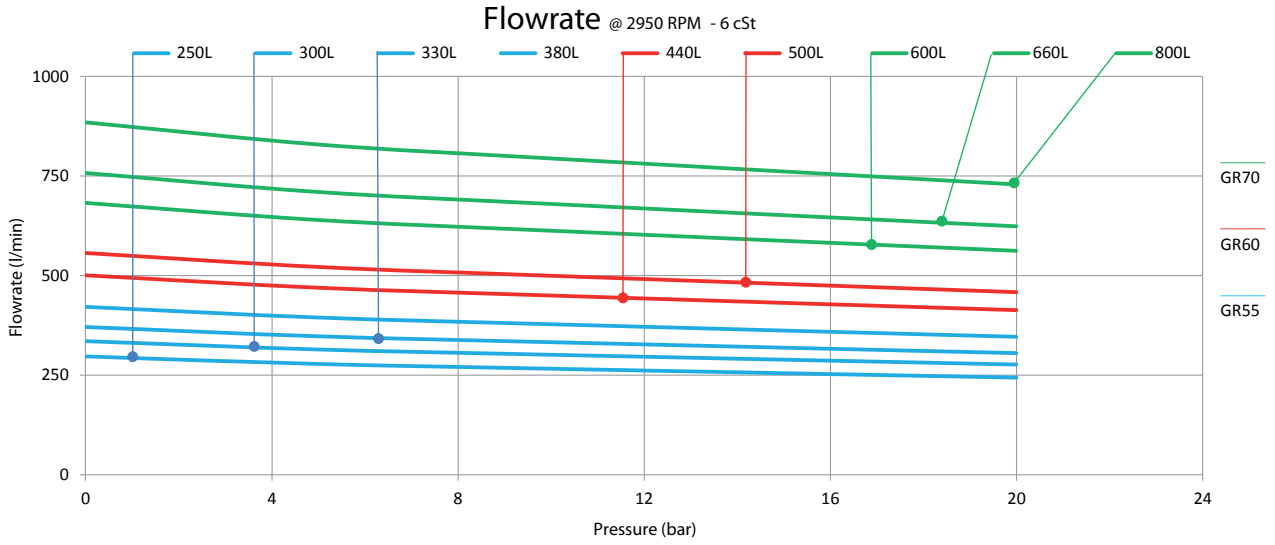

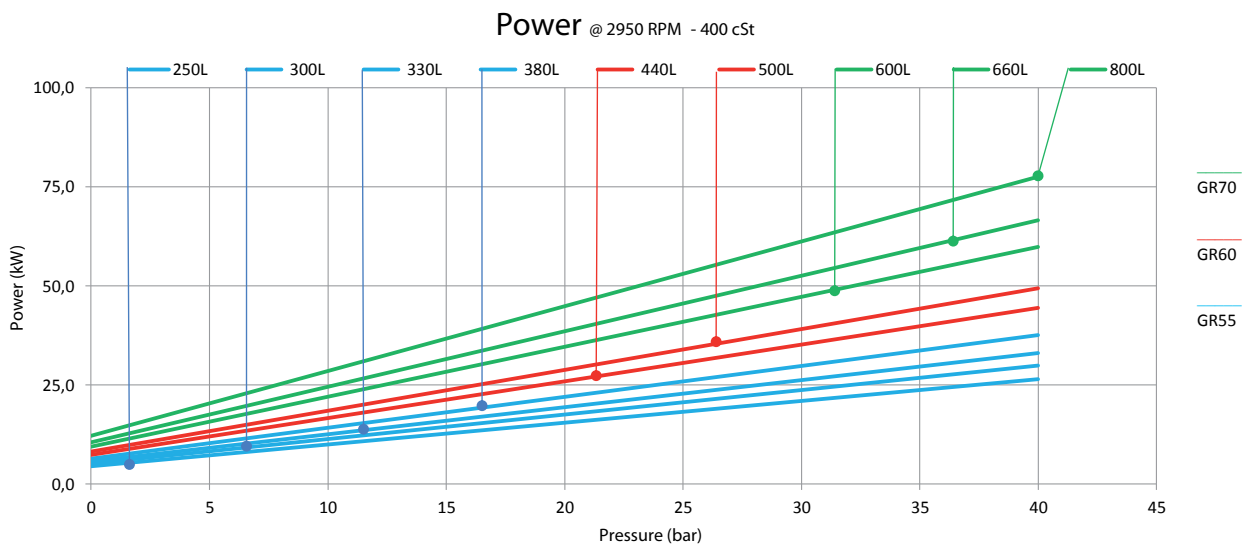
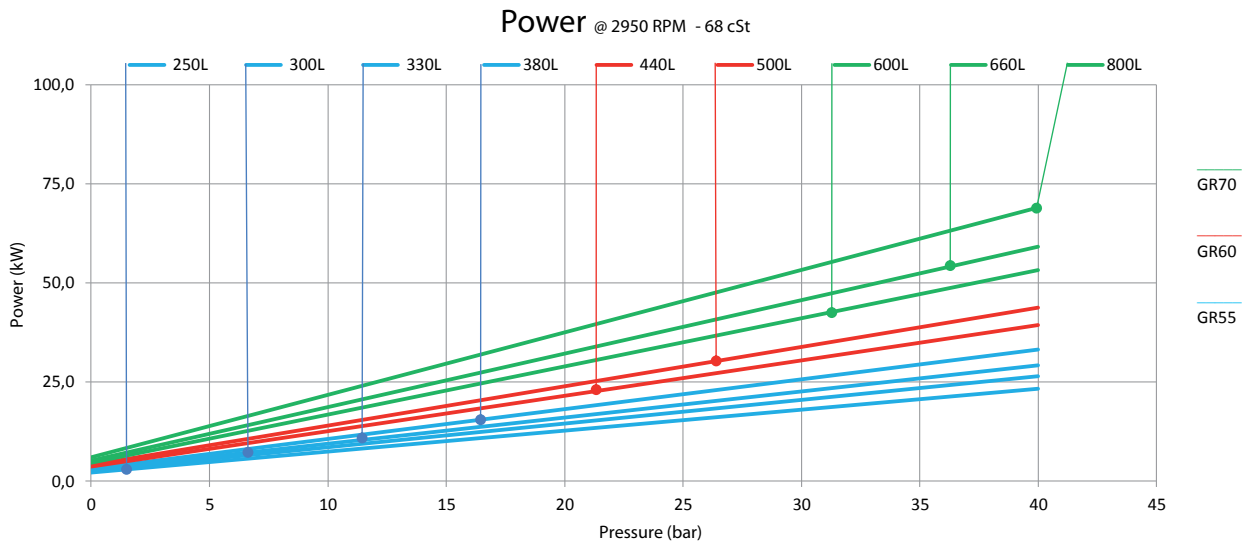
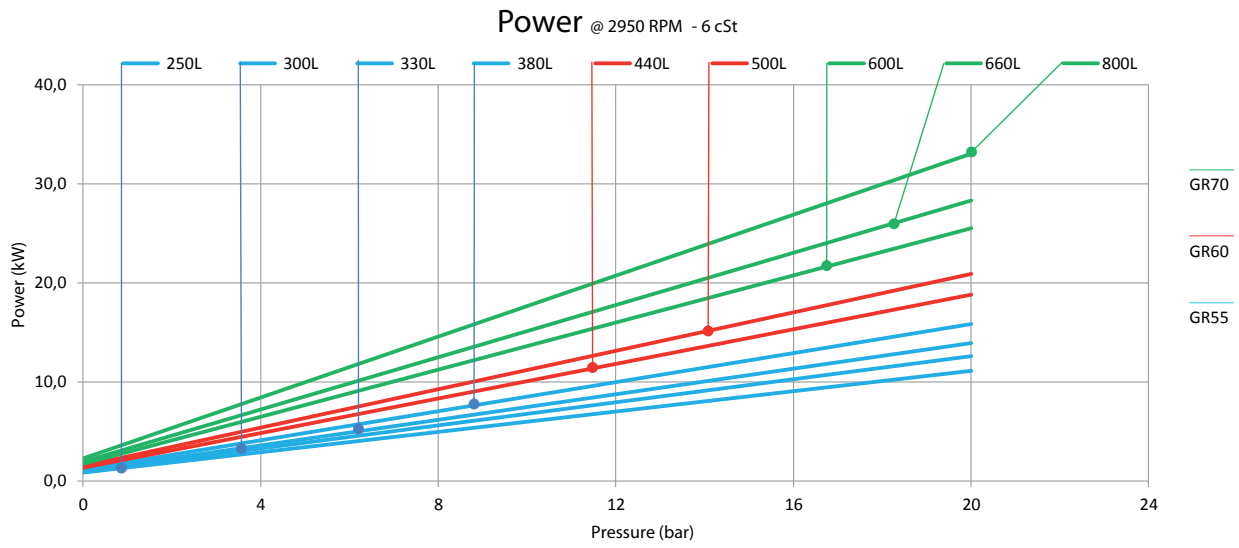

# Performances @ 1500 - GR 80-90-110

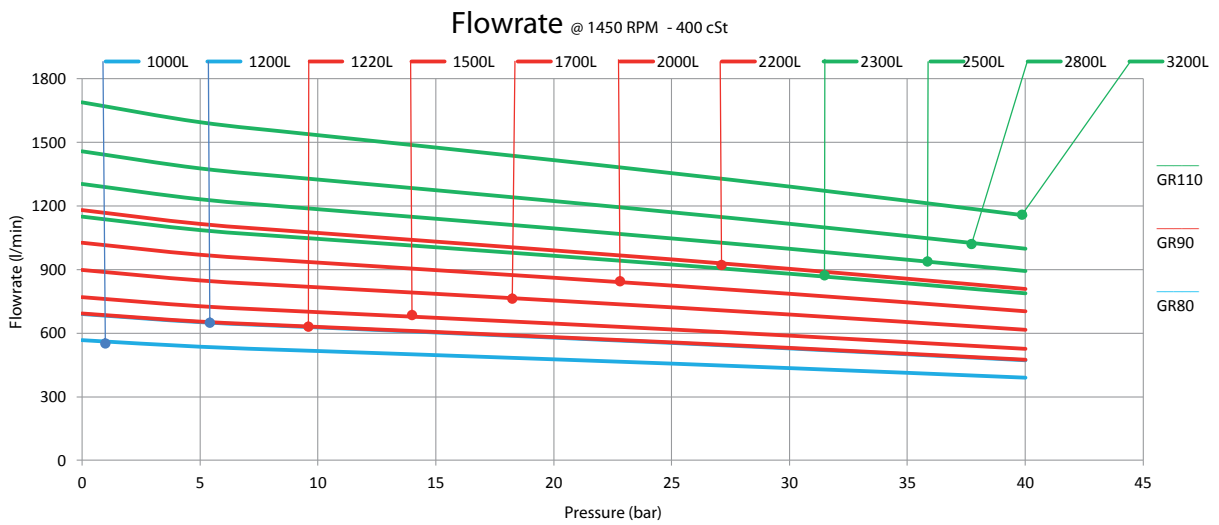
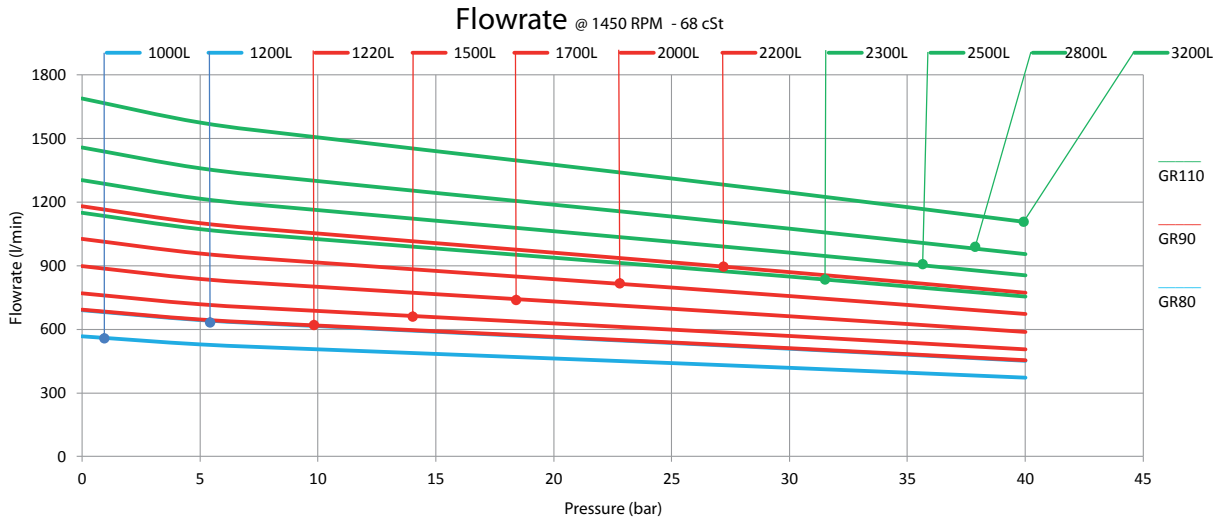
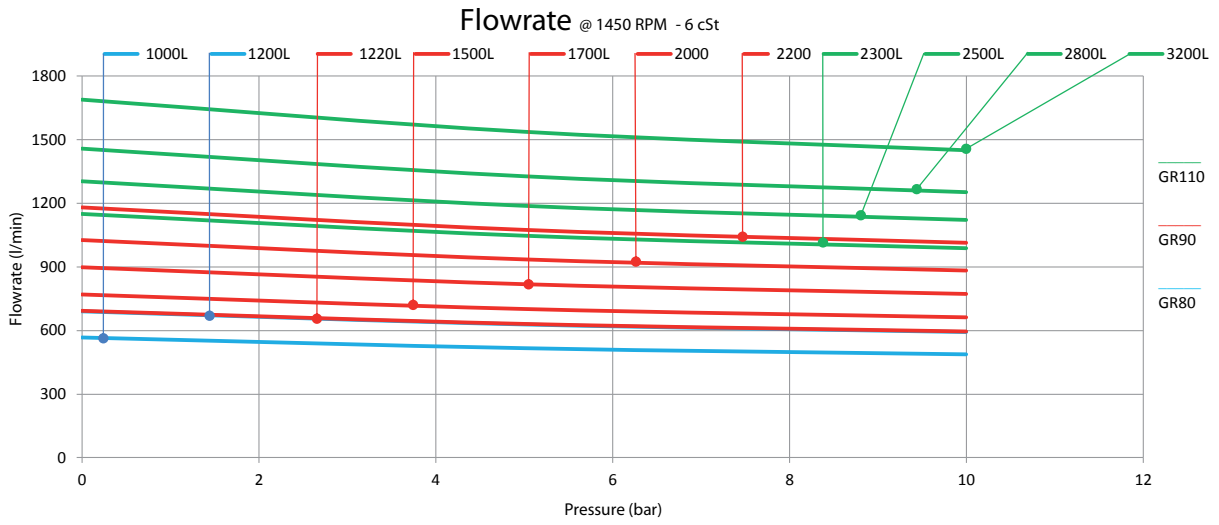

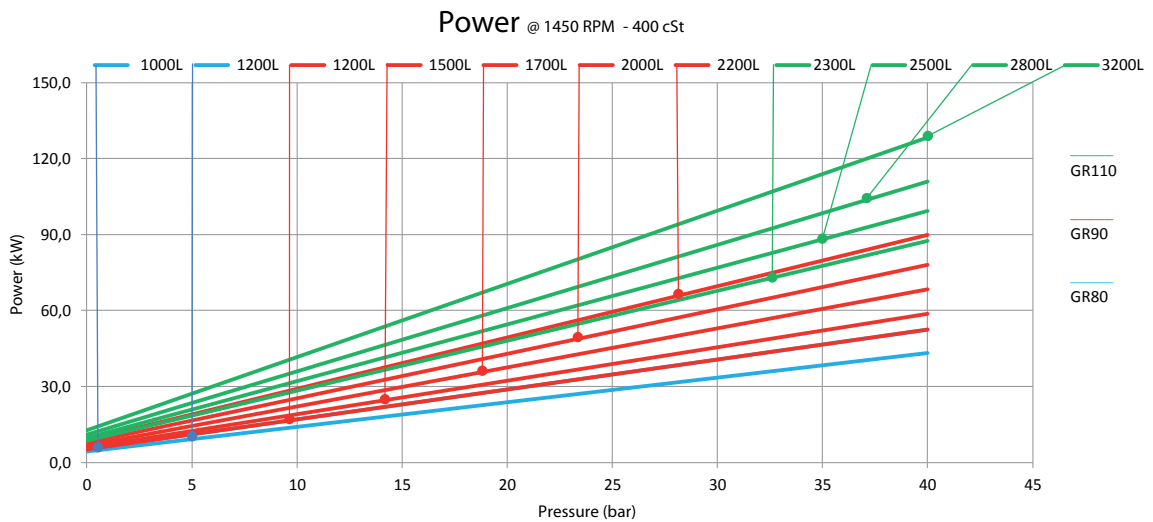
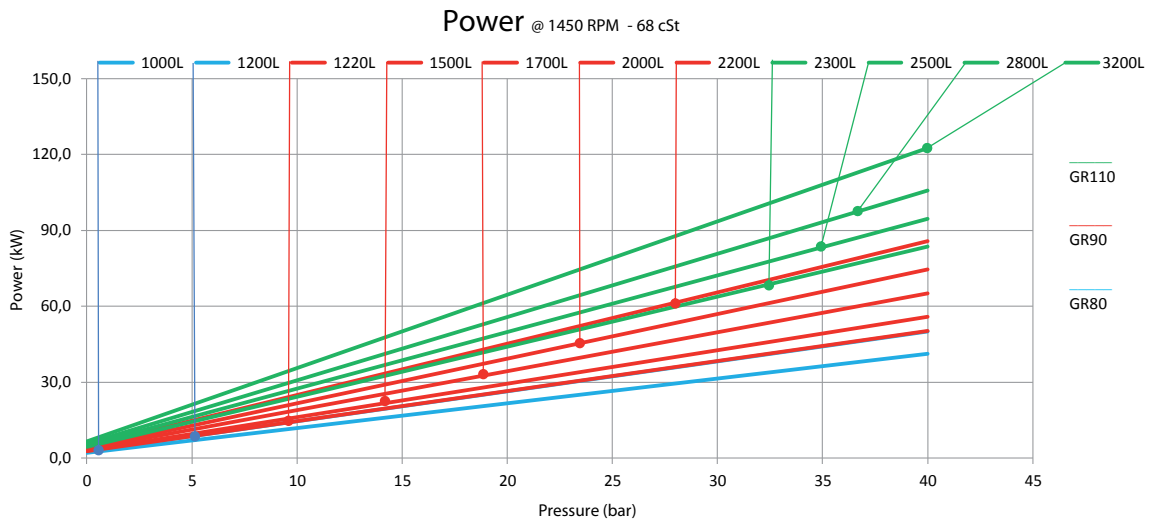
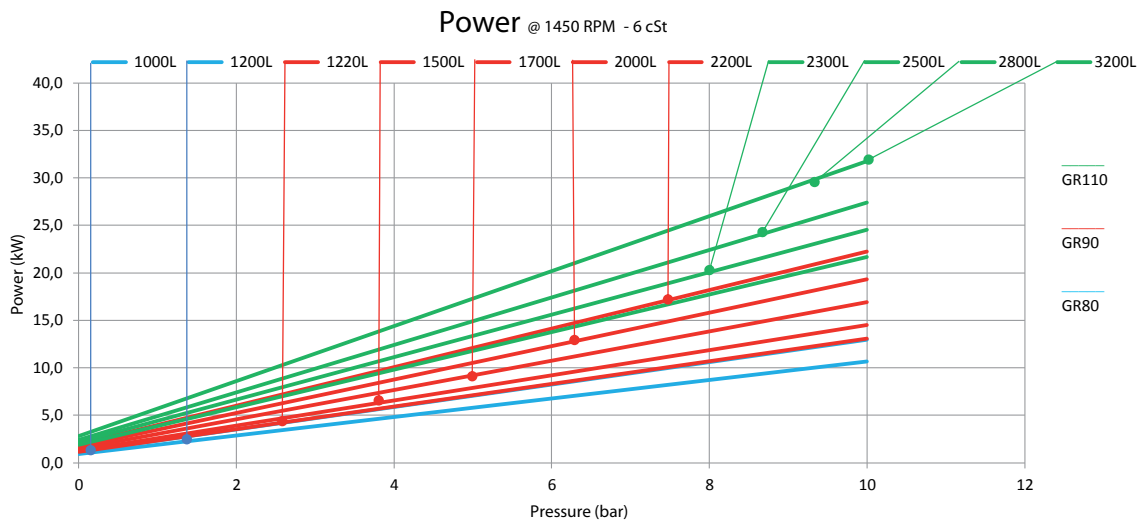

# Performances @ 3000 - GR 80-90-110

For shaft speed lower than 1.000 rpm and over 1.800 rpm please contact Settima.

Per velocità inferiori a 1.000 rpm e maggiori di 1.800 rpm contattare Settima.

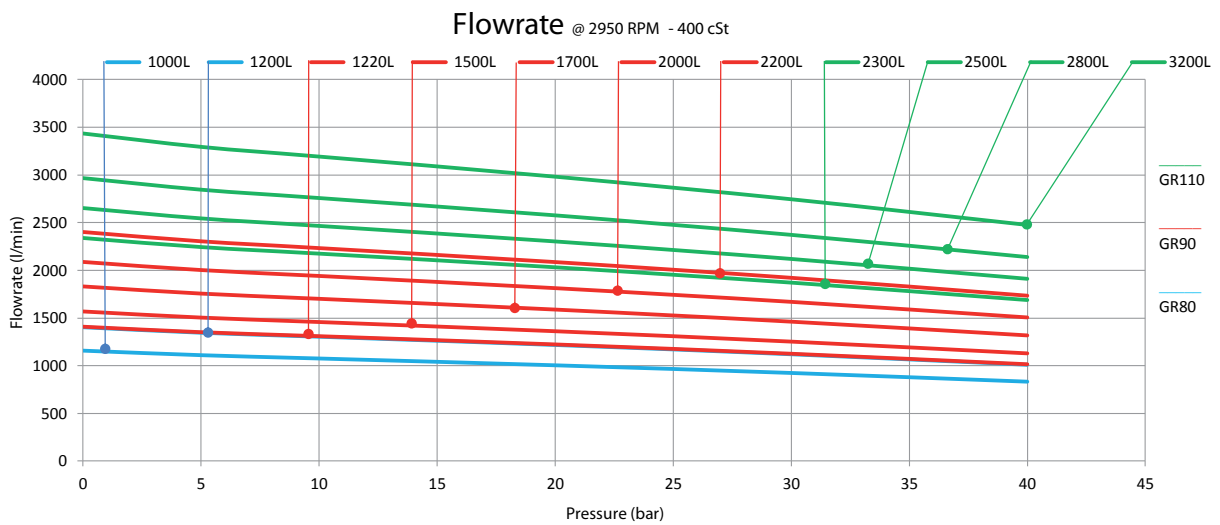
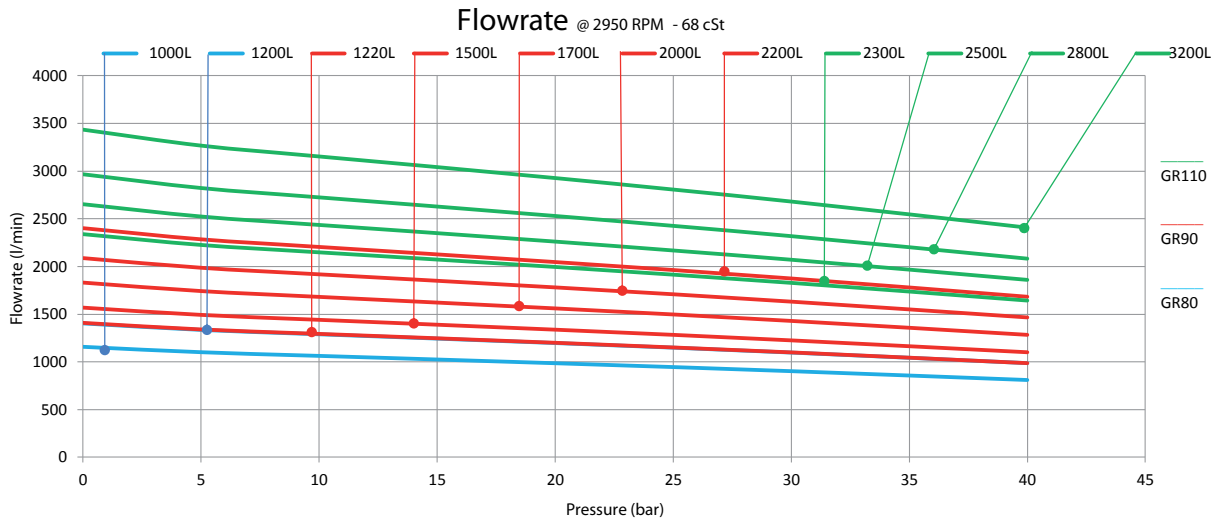
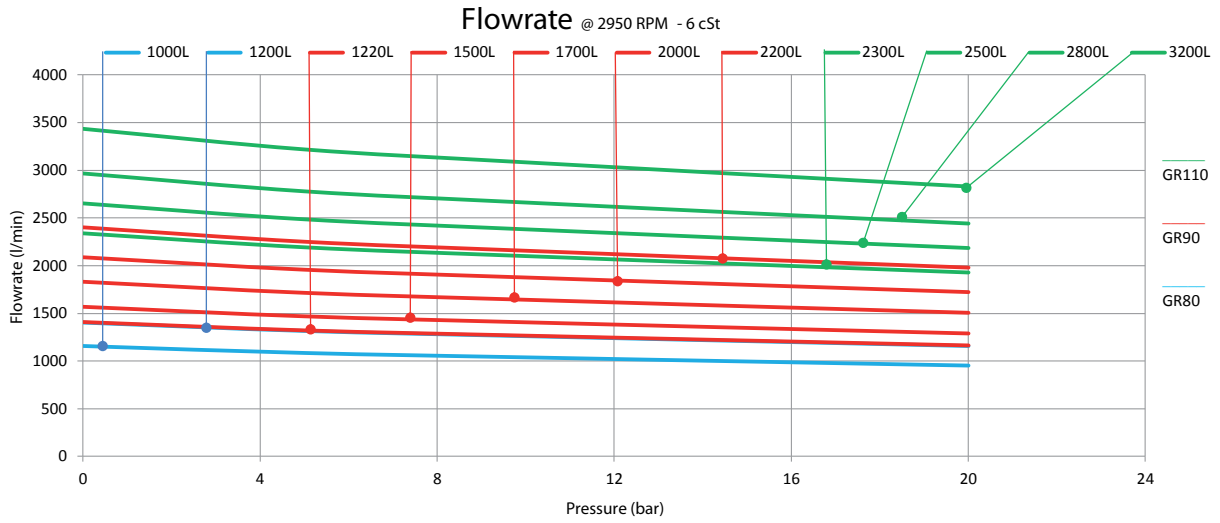



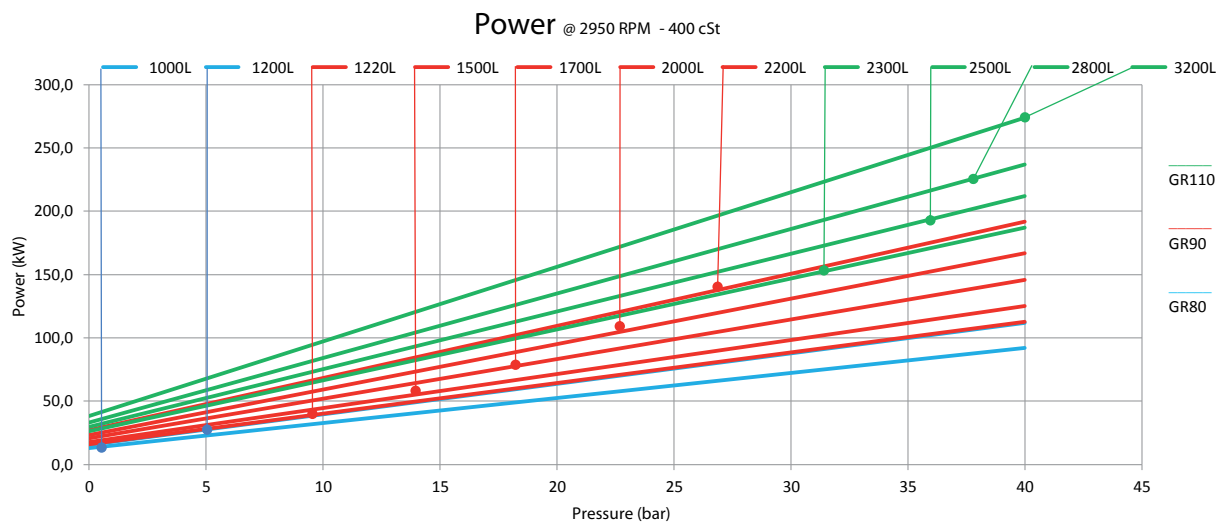
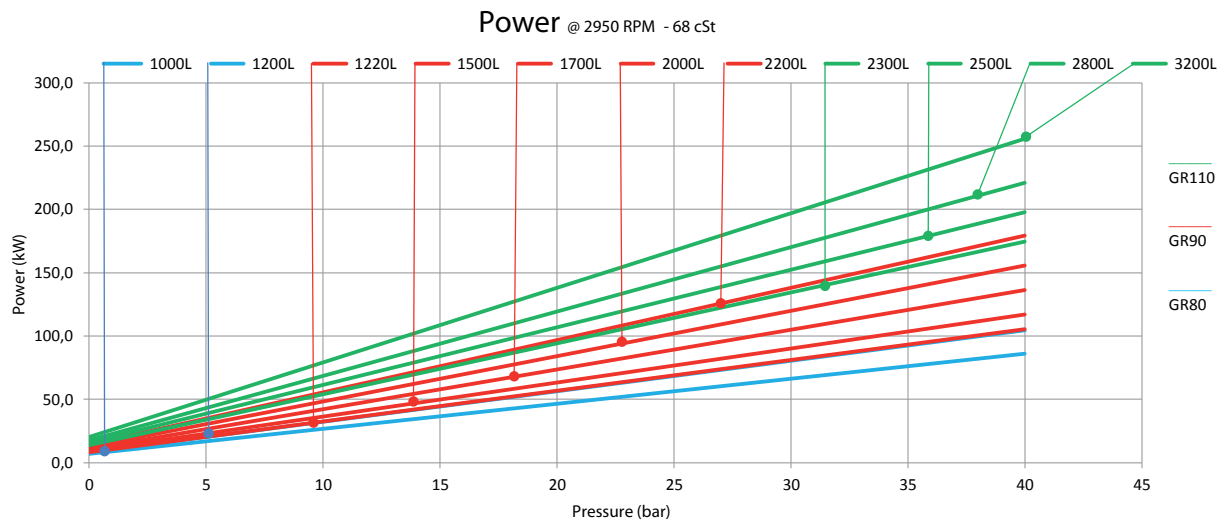
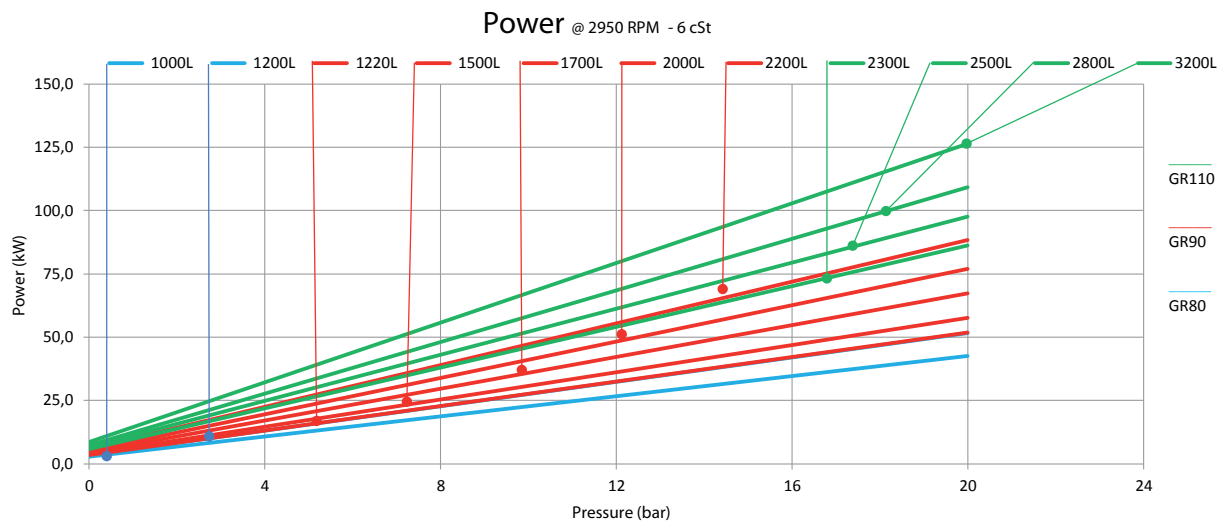

## Application form

For eventual requests of quotation and if not using the ordering code table (pag. 16), please use this application form. / Nel caso di richiesta di offerta si prega di inviare l'applicazione form a Settima.

Customer:						
Project number or name:						
<b>FIELD (select the right one):</b>			<b>APPLICATION (select the right one):</b>			
Industrial			Lubrication		Boosting	
Marine			Fuel transfer		Other:	
Oil & Gas			Filtration			
Other:			Cooling			
<b>PUM TYPE (select the right one):</b>						
SMT16B		FOTP		SMAPI (API 676 compliant)		
SMT		Continuum		Other:		
SFO		2VHL				
<b>INSTALLATION</b>						
Horizontal/vertical:						
Above liquid level:		[m]				
<b>FLUID DATA</b>						
Type / name of fluid:						
Fluid neatness (filtration, contamination)		micron		NAS		
Temperature (min,normal,max):		[°C]		[°C]		[°C]
Viscosity (max,normal,min):		[cSt]		[cSt]		[cSt]
<b>APPLICATION DATA</b>						
Flow (min, design):		[l/min]				[l/min]
Discharge pressure (normal, design):		[bar]				[bar]
Suction pressure (normal, design):		[bar]				[bar]
<b>ELECTRICAL MOTOR</b>						
To be supply by Settima (yes, no):						
Driving coupling (select the right one):		[Elastic standard]		[Steel Laminae + 5" Spacer compliant API676]		
Other coupling requirements :						
Rated speed:		[rpm]				
Power:		[kW]				
Frequency:		[Hz]				
Other motor requirement (ATEX, ...):						
Other motor requirement (painting, ...):						
<b>PUMP OPTIONS</b>						
Rotation direction (select the right one)		[CW standard]		[CCW]		
Safety relief valve:						
Mechanical seal requirements:						
Screw set material requirements:						
Pump body material requirements:						
Pump certifications required:						
Pump test required:						
External pump case painting required:						
Other pump parts painting required (i.e. foot, ..):						



**SETTIMA**

**Settima, Italy**  
Headquarter, r&d and production

**SETTIMA**

USA  
Warehouse

**SETTIMA**

Shanghai, China  
Warehouse

**Settima Meccanica Srl**  
Settima - 29020 Piacenza (Italia)  
tel. +39 0523.557623  
fax +39 0523.557256  
[www.settima.it](http://www.settima.it)  
[info@settima.it](mailto:info@settima.it)

**Settima Flow Mechanisms**  
Settima - 29020 Piacenza (Italia)  
tel. +39 0523.557623  
fax +39 0523.557256  
[www.settima.it](http://www.settima.it)  
[info@settimafm.com](mailto:info@settimafm.com)

 **SETTIMA MECCANICA**

Area Agency/Reseller

**SETTIMA**  
*flow mechanisms*