

Speed Switches

2200/2300

Catalog 2200/2300 • May 2015, Replaces Dec. 2006

TABLE OF CONTENTS

2 - 3	Applications
4	Specific Applications
5	Choosing a Speed Switch
6 - 7	Features
8	Summary of Features
9	Operating Principles
10	Building a Catalog Number
11	Catalog Number Breakdown
12 - 15	Selection Guide
16	Notes & Mounting Configurations
17	Accessories
18 - 19	Dimensional Illustrations
20 - 21	Dimensions
22 - 24	Miscellaneous Information

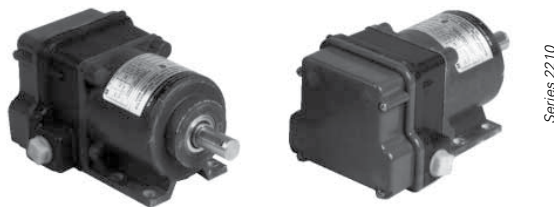

Speed Switches



Applications

A speed response switch indicates motion, speed and assists in the control of rotating machinery.

If you need to know whether or not a shaft is rotating, running at an acceptable speed or which way it is rotating, consider using a speed responsive switch. Such a device can remotely indicate shaft motion and direction and actuate control circuits at adjustable selected speeds. Numerous safety, sequencing, and interlocking control functions can be performed automatically with these versatile units.

Many automatic machine control actions are based on rotary shaft speed. Often a particular shaft speed and/or direction of rotation is important. For example:

1. In certain portions of a machine cycle, motion of any kind is unwanted.
2. Rotation in the wrong direction must be prevented.
3. A particular shaft speed marks the beginning of a dangerous overspeed or underspeed condition.
4. Sequential operations must take place at definite rotary speeds.

Where sensing and/or control of rotary speed is required, speed responsive switches are often the best choice. These rugged reliable components open or close electrical contacts at preset adjustable rotary speeds, in one or both directions of rotation. The contact operations can effect a variety of automatic indicating and control actions. A number of proved industrial applications for these units are listed below:

Industrial Uses

Electric Motors

- Indicate rotation and/or direction of rotation.
- Plugging and anti-plugging or preventing overspeed.
- Provide speed governing and adjustable speed action for motors.

Materials Handling Equipment

- Indicate slowdown or stoppage of rotating shafts on rotary feeders, conveyors, bucket elevators, and other material handling equipment.
- Operate emergency braking equipment on cranes, hoists, etc.

Production Equipment

- Disconnect or stop drive if speed drops below normal due to a machine jam or other type of overload.
- Energize electromagnetic clutches and brakes at preset speeds.
- Indicate number of equipment starts and stops (with counter)
- Interlock equipment actions.
- Prevent accelerations, slowdowns and reversals of mixers and centrifuges.
- Provide overspeed and under-speed protection for machines and processes.
- Shift gears automatically (machine tool transmissions).
- Remotely indicate faulty operations of any rotating parts.

General Uses

Plugging

A common use for a speed responsive switch is in plugging an electric motor. (Rapidly stopping an electrical motor by applying reverse power through a reversing contactor). Plugging increases the number of machine operations per unit of time by reducing the stopping time of the motor and the machine it drives. When used for plugging, a speed responsive switch acts with a magnetic control to allow reverse power to be applied to a rotating motor. The power is automatically removed by the switch when the motor approaches zero speed, to prevent undesirable reversing.

Anti-Plugging

Anti-plugging is used to prevent the application of reverse power to a motor operating above a preset speed. One area is in equipment with high inertia loads, where plugging from full speed in either direction could cause motor or equipment damage. A speed responsive switch used for anti-plugging will not allow a motor to be plugged until it has decelerated to a predetermined safe speed.

Material Handling Interlocking & Sequencing

Another useful application area for speed responsive switches is in bulk material handling systems. The illustration on the next page shows the various functions of speed responsive switches:

Switch "A" senses rotary feeder shaft motion. Slowing or stopping of the feeder shaft indicates a malfunction such as a jammed feeder or a plugged outlet. The speed responsive switch is set to open the drive motor circuit at some feeder shaft speed below normal.



Non-Reversing Arrangement

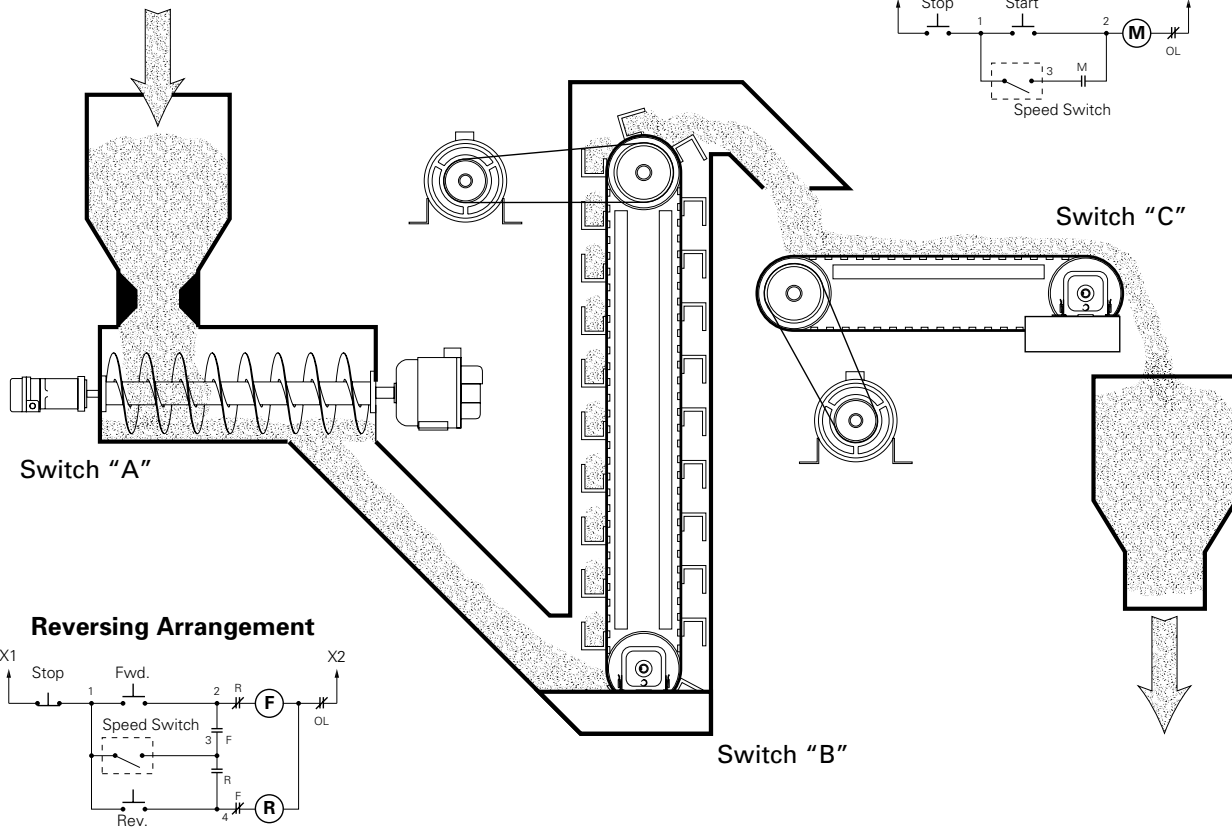
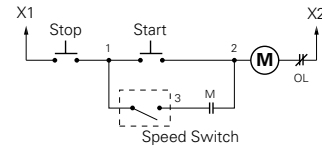

Reversing Arrangement

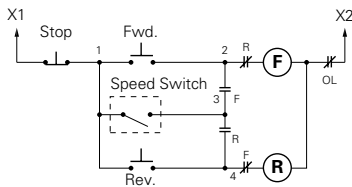

Illustration of Mechanical and Electrical Interlock uses of Speed Switches

Switch "B" monitors the speed of the elevator boot pulley, it senses a belt break or overload, or maladjustment of the boot pulley.

Switch "C" senses a conveyor breakdown or overload, or a defective adjustment of the idler pulley.

All the speed responsive switches in this application can be interlocked so that slowing or stopping of one unit in the system will automatically shut down the whole system. This will prevent the pile-up of material in or on malfunctioning units.

Other Typical Applications

Speed responsive switches can be used in many other interlocking applications. For example – in a rotary kiln

dryer, action must be taken immediately if the dryer stops turning. A speed responsive switch can sense dryer stoppage and turn off the heat. A similar application calls for a speed responsive switch to shut off the gas to a burner if a blower fails. Computers and expensive electronic equipment can also be shut down if a blower fails.

Additional Features

A useful safety feature of some speed responsive switches is a magnetic lockout coil. This prevents false starting of a motor in a plugging circuit if an operator turns the motor by hand. The coil is connected across two motor starter terminals. Operation of the speed responsive switch is prevented unless electrical power is applied to the lockout coil.

Manual and automatic reset features are also available. One application for a manual reset button is in unattended pumping stations. If a speed responsive switch shuts down a pump drive because of improper speed, a signal will be sent to a central control station. The pump drive cannot be restarted, however, until a repairman visits the remote station and operates the manual reset button, which forces repair of the fault causing the shutdown.

Specific Applications

Series 2200

Machine Tools — Euclid Type PR Series can be used to increase production as a zero-speed plugging switch with normally open contacts incorporated with a magnetic reverse panel to bring AC motors to a quick stop.

Motion Interlocking — such as on conveyor systems, where a centrifugal switch is driven by the main conveyor at a location near the junction with a feeder conveyor. The normally open centrifugal switch contacts are connected in series with the control circuits of the magnetic controllers for the motors driving the feeder conveyors. If the main conveyor accidentally stops, the centrifugal switch driven by that conveyor will automatically stop the motors driving the feeder conveyors, preventing material from being piled up on the stalled conveyor by the feeder conveyors.

Series 2210

Euclid Type C switches provide overspeed & underspeed protection and precise speed sensing with high repetitive accuracy to indicate slipping or broken conveyor belts, preventing material pileup; prevent overspeed or underspeed of motors, generators, fans & pumps; control starting of diesel engines, prevent damage to rotating industrial machinery, when speeds increase or decrease from safe values; for plugging applications to assure quick & safe stops; sequential control of functions at specific speeds.

Series 2220

With Production Equipment — Euclid Type F switches may be incorporated to stop motor drives in case of machine jams or overloads; energize electromagnetic clutches and brakes; indicate (with a counter) equipment starts and stops; prevent slowdowns and reversals of mixers and centrifuges; provide reversal and unwanted motion protection for compressors, pumps, electric motors, test equipment; automatically shift gears on machine tools and power transmissions; indicate motion or broken shaft for stamping presses.

Series 2243

Conveyor Manufacturers — use it to indicate jammed screw conveyors; slipping or broken belts; very low speed sequencing.

Machine Manufacturers — utilize the Euclid Type D switch in determining time in seconds or even fractions of a second to stop motion of a press or machine for protection to personnel or indexing machines so that proper and exact holes are punched accurately. Sequential control of functions at specific speeds is a natural application; prevent damage to rotating industrial machinery when speed increases or decreases from safe standards; shift linkages on engine lathes.

Series 2260

On Production Equipment — The Euclid Type E Switch can be used to stop drive equipment in cases of jam or motor drive slowdowns due to severe overload condition; can energize or control electromagnetic brake circuitry to provide consistently accurate stops; prevent inadvertent drive reversals of mixers, pumps, and winches; provide over or underspeed protection and/or indication; indicate and prevent improper sequence of gear or speed changes; can indicate “lost rotary cam limit switch” speed on stamping or welding presses.

Series 2310

Numerous production control and related applications include underspeed as with chain, belt, screw, and related conveyors; also zero-speed sensing for web, belt or coupling breakage, etc. Specific production uses include start-up of motors for mixing units, rotary kilns, blower fans, mine pumps, sequencing conveyors, etc.

The 3-wire Low Voltage Sensors are ideally suited to installations with hazardous atmospheres as the 24V DC power level and non-arcing plastic housing. They can be used in intrinsically safe installations when applied with appropriate zener barrier protection.



Choosing a Speed Switch

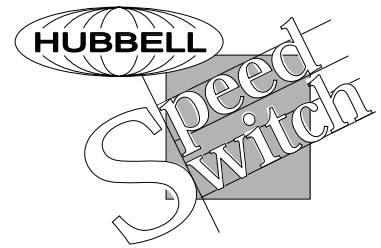

The first step in selecting a speed responsive switch is to determine what it must do electrically in response to shaft rotation. Points that should be resolved include:







1. What contact configurations (SPST, SPDT, etc.) are required?
2. Are snap-action or butt-type contacts needed? Snap-acting contacts are more sensitive when speed changes in the control zone are slow. Butt-type contacts are satisfactory for rapid speed changing conditions.
3. Is direction sensing required? This suggests the use of a speed responsive switch that can detect direction of operation, and requires no change-over for direction of rotation.
4. Is the contact speed adjustment range satisfactory?
5. Is the maximum running speed rating of the switch compatible with the application?
6. Will contact rating (current, voltage, AC or DC, type of load, etc.) ensure long switch life?
7. Have special electrical features (magnetic lockout coil, manual or automatic reset, etc.) been specified?
8. The operating environment should be checked and a suitable enclosure specified for the switch.
9. Operating temperature ratings should be considered in selecting a speed responsive switch.
10. Specify surface (standard) or flange mounting enclosures.
11. Where a separate switch is to be direct-driven by a motor or a machine shaft, the use of a flexible coupling is recommended between the driving and driven shafts. End thrust should never be imposed on a speed responsive switch and speed increasers are available to change the operating range of a switch. Direct rigid connections and chain drives are not recommended.

Directional vs. Non-Directional Switches

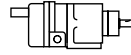
Directional switches are units that sense the direction in which the shaft is rotating by means of operating only one of two isolated circuits for a given direction of shaft rotation.

Non-directional switches do not sense the direction their shaft is rotating. The same circuits operate in either direction of shaft rotation.

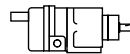
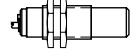
The table at the right shows which switches are directional and non-directional.

Directional Units	
Field Setting  Series 2220  Series 2260 2260-012, -022 & -032	Factory Setting (recommended)  Series 2200 PR-026, PR-029 & NPR-029B
Non-Directional Units	
 Series 2200 Except PR-026, PR-029 & NPR-029B	 Series 2260 2260-011, -021 & -031
 Series 2210	 Series 2310
 Series 2243	

Directional vs. Non-Directional Identification Table

Features

Series 2200

Euclid Type PR Series are pilot circuit switches with contacts that are opened or closed by means of centrifugal force. The contacts are therefore responsive to changes in speed so that these switches can be used for plugging, overspeed or underspeed protection, nonplugging, and for motion interlocking.

- Mill Construction, Cast Iron Frame and End Plates
- NEMA Style Enclosures for Indoor & Outdoor Applications
- Non-Directional Contacts
- Silver-to-Silver Contacts
- Easy Accessibility to Contacts and Flyweight Assy
- Permanently Lubricated Precision Bearings
- Surface or Flange Mounting
- 5/8" dia Stainless Steel Shaft
- Optional Rear Shaft Extension, Manual Reset Contacts
- AC and DC, Snap-Action Precision Switch

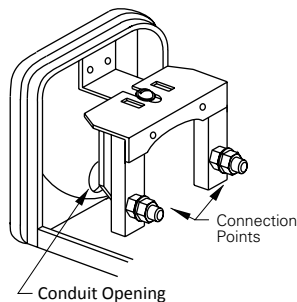

Series 2200 Connection Panel

Series 2210

Type C speed responsive switches assure maximum protection of material handling systems and rotating equipment. They provide overspeed and underspeed protection with precise speed sensing. These switches have excellent repetitive accuracy and are basically unaffected by temperature variations.

- NEMA Type Enclosures for Indoor, Outdoor & Hazardous Environment
- Rugged Construction
- Contacts Easily Adjustable While Running
- High Speed Operation to 4700 RPM ♦
- Low Speed Operation from 10 RPM ♦
- Snap-Action Contacts or Pneumatic Air Valve
- Oversize Low Friction Bearings
- Surface or Flange Mounting
- 5/8" dia Input Stainless Steel Shaft

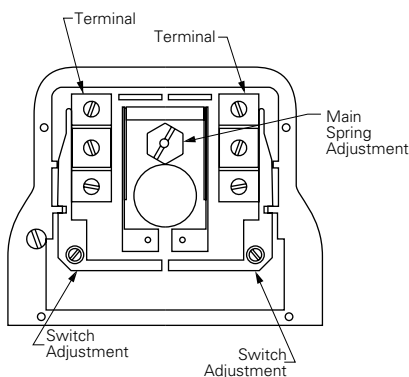

Series 2210 Connection Panel

Series 2220

Type Euclid F Type speed responsive switch is low speed, pilot circuit device designed to sense rotation of production or material handling equipment and provide an electrical interlocking signal with other mechanical or electrical devices. The Type F switch as a stop motion indicator assures safe and proper sequential operation of rotating equipment.

- NEMA Type Enclosures for Indoor, Outdoor & Hazardous Environment
- Rugged Construction
- Contacts Easily Adjustable While Running
- Low Speed Operation from 0.8 RPM ♦
- Snap-Action Contacts, SPDT Operation in Either Direction
- Oversize Permanently Lubricated Bearings
- Surface or Flange Mounting
- 5/8" dia Input Stainless Steel Shaft

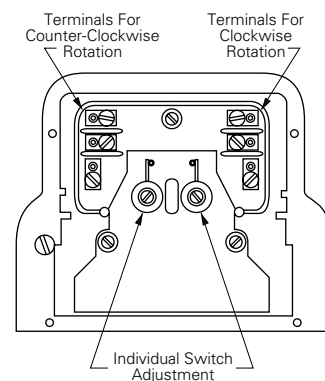

Series 2220 Connection Panel

♦ Select specific model to match speed requirements.



Series 2243

Euclid Type D Speed Responsive Switches are highly precise, non-directional, solid state, low speed responsive devices for industrial applications. The unique light chopping network "digitally controlled" output relay can easily be adjusted to open or close an electric circuit at speeds as low as .6 RPM. Type D switches provide precise speed sensing and sequential control with high repetitive accuracy.

- Precise Speed Sensing
- Low Speed Operation from 0.6 RPM♦
- High Running Speed to 3600 RPM
- NEMA & CEMA Type 4 Encl.
- Silicon Solid State Components, Integrated Circuits, Transient Voltage Protection
- Digital Controlled Output Relay
- LED Light Chopping Disc and Cell Assembly
- Oversize Bearing, Rugged Enclosure, Double Shaft Seals with Lubrication Fitting
- Adjustable Differential

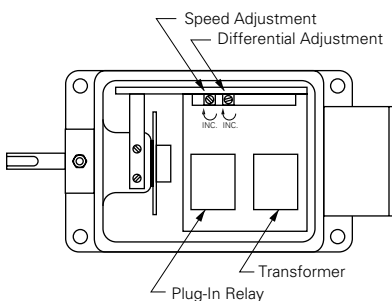

Series 2243 Connection Panel

Series 2260

The Bulletin 2260 Type E Speed Responsive Switch is a medium speed pilot circuit device designed to precisely and rapidly sense rotational speed of production and materials handling equipment. The sensor provides an electrical interlocking signal to associated electromechanical devices. The use of the Type E Switch as a "Stop-Motion" indicator can assist in assuring safe and consistently proper sequential operation of rotating equipment.

- Medium Actuation Speed Range 3 – 300 RPM
- Output Actuation Speed Adjustable While In Motion
- NEMA 13 Enclosures, Dust-tight and Oil-tight Indoor
- Relay Contact Output - SPDT
- Oversize Bearings and Shaft Support
- Surface/Flange Mounting
- Non-directional or Directional Sensing
- 5/8"Ø Stainless Steel Shaft

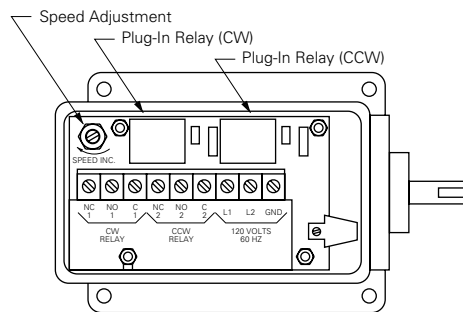

Series 2260 Connection Panel

Series 2310

The 2310 Non-Contact Speed Responsive Switch is a self-contained solid state device capable of sensing the presence of metal without physical contact. This high-density tubular package senses metal targets in a nominal 10 mm (0.4") sensing distance from the sensing head for targets of a typical size, 30 mm (1.20") square by 1.5mm (0.06") thick.

- Solid State Speed-Sensing Device
- Self-Contained Control Adjustments and Diagnostics
- Ease of Installation
- Maintenance Free
- Automatic Reset Each Cycle
- High Impact Housing
- Available in models for Low DC Voltage Three Wire Applications or AC Voltage Two Wire in Line Applications

♦ Select specific model to match speed requirements.

Summary to Features

The table below covers the broad range of features available in each series of Hubbell's speed switches. Use this guide to quickly locate the general requirements of your application and then select your speed switch from the detailed switch selection tables in the back of this digest.

	Series 2200	Series 2210	Series 2220	Series 2243	Series 2260	Series 2310
Type of Mechanism	Mechanical Centrifugal Force	Mechanical Centrifugal Force	Mechanical Fluid/Eddy Current	Electronic	Electronic	Non-Contact Sensing
Operating Range (ascending trip)	80 – 2550 RPM	10 – 3700 RPM♦	1 – 90 RPM♦	.6 – 300 RPM	3 – 300 RPM	6 – 150 RPM or 150 – 3600 RPM
Operating Range (descending trip)	65 – 2450 RPM	9 – 3500 RPM♦	1 – 59 RPM♦	.57 – 240 RPM	2.25 – 225 RPM	6 – 150 RPM or 150 – 3600 RPM
Max Running Speed	3600 RPM	5000 RPM♦	2000 RPM♦	3600 RPM	3600 RPM	Max. Sensing Distance – 12mm
Adjustment	Field Adjustable <i>(Factory Set Recommended)</i>	Field Adjustable	Field Adjustable	Field Adjustable	Field Adjustable	Field Adjustable
Repeatability	±5%	±5%	±20% <i>(at constant ambient)</i>	±2%	±2%	±6%
Rotation Sensing	Non-Directional	Non-Directional	Directional	Non-Directional	Directional & Non-Directional	Non-Directional
Voltage	AC or DC	AC or DC	AC only	AC only	AC only	AC or DC
Current Rating (continuous)	10 amps (max.) @ 120/240V AC 10 amps (max.) @ 125/240V DC	10 amps (max.) @ 120/240V AC @ 125/240V DC	3 amps (max.) @ 120V AC	5 amps (max.) @ 120V AC	7 amps (max.) @ 120V AC	200 mA (max.) @ 120V AC
Interrupting Ratings	3 amps 120V AC @ 35% P.F.	3 amps 120V AC @ 35% P.F.	1.5 amps 120V AC @ 35% P.F.	2 amps 120V AC @ 35% P.F.	2.5 amps 120V AC @ 40% P.F.	n/a
Input Voltage	120/240/480V AC or 125/240V DC	120/240/480V AC or 125/240V DC	120/240V AC	115V AC ±10% 50/60 Hz 15 Watts	115V AC ±10% 50/60 Hz 4 Watts	10 – 30V DC ±10% or 102V – 132V AC 50/60 Hz 300 mA (max.)
Ambient Temperature	-60°F to +250°F (-50°C to +121°C)	-60°F to +250°F (-50°C to +121°C)	-60°F to +250°F (-50°C to +121°C)	32°F to +158°F (0°C to +70°C)	0°F to +158°F (-18°C to +70°C)	-4°F to +158°F (-20°C to +70°C)
Enclosure	Cast Iron End Plates & Frame with Steel Wrap Cover	Fiberglass Rein- forced Polyester Resin and/or Cast Aluminum	Fiberglass Rein- forced Polyester Resin and/or Cast Aluminum	Cast Aluminum	Cast and Drawn Aluminum	Glass Filled Polyester or Nickel Plated Brass
NEMA Ratings	1, 3R	4, 7, 9, 10 & 13	4, 7, 9 & 13	4	13	4X & 13
Mounting Configurations	Surface or Flange	Surface or Flange Single/Double Gear Clusters	Surface or Flange Single/Double Gear Clusters	Surface or Flange	Surface	Surface Observed Free Zone
Max Overhung Load	40 lbs @ 3600 RPM	34 lbs @ 3600 RPM	20 lbs @ 3600 RPM	34 lbs @ 3600 RPM	20 lbs @ 3600 RPM	n/a
Max End Thrust	20 lbs @ 3600 RPM	10 lbs @ 3600 RPM	10 lbs @ 3600 RPM	10 lbs @ 3600 RPM	20 lbs @ 3600 RPM	n/a

♦ Internal gear clusters available to reduce standard operating/running speed range.

Operating Principles

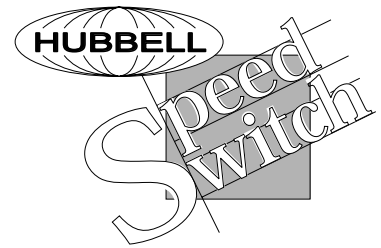

A speed-responsive switch consists of three major elements: an input member, a speed sensor and an output member.

The input member is a shaft. It is rotated by the motor or machine being controlled through a flexible shaft, a chain drive, a belt drive, or a gear drive.

Speed sensing can be accomplished in several ways. Common methods employ centrifugal force, fluid/eddy current actuation, and electronic (solid state) units.

The output member of a speed responsive switch includes one or more electrical contacts or pneumatic air valves that either open or close as directed by the speed sensor. Selection of the output member depends upon the application. For example, a unit used to detect overspeed needs only a pair of contacts that will either close or open when a particular speed has been attained. On the other hand, a speed switch that controls starting, overspeed, and underspeed of a machine or process needs several contacts that operate at different speeds.

Standard speed responsive switches are available with up to two sets of contacts. If more control functions are required, multiple units can be operated from a single shaft or from the shafts of several machine sections, or control relays can be employed to provide the needed circuits.

An interesting variation in type of output member is found in our centrifugal unit that operates an air pilot valve instead of an electrical switch. This unit was developed at the request of a gas engine manufacturer so that he could eliminate the use of an electrical system in a remote, natural gas pumping station. The air pilot valve controls a large valve supplying gas to the engine. It provides underspeed or overspeed protection for the engine. Valve operation is a function of both the switch speed and the pressure in the pneumatic control system.

Eddy Current Motion Detection

The centrifugal method of measuring speed has been used for over 50 years in the industrial marketplace and utilizes a simple physical process. The Series 2220 switch on the other hand uses a technology not quite so old – fluid/eddy current motion detection. Inside the driven end of the switch is a hermetically-sealed rotating chamber which contains silicone fluid. Inside this chamber, a concentric cylinder suspended on precision ball bearings is turned by the viscous drag of the silicon fluid.

The torque of the internal cylinder is transmitted through the walls of the chamber by powerful permanent magnets which operate the snap-action contacts in the contact compartment.

Electronic Motion Detection

Hubbell offers three electronic models – Series 2243, 2260 & 2310. Both Series 2243 and 2260 use a light chopping disc that is mounted directly on the input shaft. When the shaft is rotated, the disc segments interrupt an IR light beam between a solid state LED light source and a light sensitive cell. A specific number of light pulses are produced for each revolution of the shaft. The pulses are counted by the digital circuitry, actuating an output relay at a set point.

The latest Hubbell speed switch, Series 2310, utilizes proximity sensing technology. Proximity sensing uses a non-contact sensing device that produces an output signal whenever a metallic object is detected and responds to the rate of that detection. Due to this, no input member, shaft extension or physical connection to the rotating equipment is required. By the use of this non-contact sensing method, no pressure of any sort needs to be exerted on the scanned material. Magnetization of the scanned material does not take place therefore iron filings or magnetized particles will not collect on the scanned material or on the proximity sensor.

Calculating Response Time for Series 2243/2260

$$\text{Ascending Response Time (sec.)} = \frac{2}{\text{Input Shaft Speed (rpm)}} + C$$

C = .015 (Series 2243) & .013 (Series 2260)

$$\text{Descending Response Time (sec.)} = \frac{1}{\text{Descending Set Point (rpm)}} + C$$

C = .010 (Series 2243) & .006 (Series 2260)

Building a Catalog Number

One of the most difficult procedures for any complex and thorough product line such as Hubbell's speed switches, is determining the catalog number for the switch you need for your application. We have been able to simplify this.

Catalog numbers for mechanical speed switches (Series 2200, 2210, 2220) are comprised of three basic parts (shown on adjacent page) – the type of switch, the enclosure or NEMA rating required for the switch and the options available. The catalog number for the switch is made up of a variety of letters and numbers. They are usually dictated by the application the switch will be used for.

Catalog numbers for electronic speed switches (Series 2243, 2260, 2310) are much simpler due to their single unit/single function construction.

How to Build the Catalog Number

Series 2200♦

Determine the type of contacts you want for your speed switch. The table shows the type of contacts available. Under each group of contact types, the switches are listed by the maximum running speed. Once determining the correct area of the table for the maximum running speed, select the switch with the contact adjustment range required. The catalog number is shown to the right.

Next determine what type of housing your application requires and add the appropriate suffix. The standard enclosure is NEMA 1 gasketed and several options are available. Add the appropriate suffix for these options to complete the catalog number.

For speed switch pricing, see the companion **Speed Switch Price List**.

♦ Refer to appropriate selection guide.

Series 2210/2220♦

Determine the type of contacts you want for your speed switch. The table shows the type of contacts available. Under each group of contact types, the switches are listed by the maximum running speed. Once determining the correct area of the table for the maximum running speed, select the switch with the contact adjustment range required. The catalog number is shown to the right.

Next determine what type of housing your application requires and add the appropriate suffix to the catalog number.

To determine the options available read further across the column. If you require flange mounting or manual reset button(s) and those options are available replace the "x" in the catalog number with the appropriate letter. You now have a complete catalog number.

If you do not require any of these options, simply remove the "x" from the completed catalog number, leaving the enclosure NEMA rating.

For speed switch pricing, see the companion **Speed Switch Price List**.

Series 2243♦

Determine whether you need over-speed or under-speed protection, the shaft diameter, and your rpm requirements. Using the table on page 15, you can then select the proper catalog number.

For speed switch pricing, see the companion **Speed Switch Price List**.

Series 2260♦

Determine whether you need directional or non-directional contacts, type of mounting, and your rpm requirements. Using the table on page 15, you can then locate the proper catalog number.

For speed switch pricing, see the companion **Speed Switch Price List**.

Series 2310♦

Determine whether you need normally open or closed contacts, whether your electrical circuit is AC or DC, and if DC whether your electrical design requires load sinking (NPN) or load sourcing (PNP); the housing material preferred, and your rpm requirements. Using the table on page 15, you can then select the proper catalog number.

For speed switch pricing, see the companion **Speed Switch Price List**.

Ordering Example

You need a speed responsive switch for overspeed detection. The switch needs to operate at 2100 rpm on increasing speed, be flange mounted to the motor with a manual reset feature. One NC contact for a 110V AC pilot circuit is required and the contact needs to operate in either direction.

The switch you select is the Series 2210. The catalog number for the switch to meet these requirements is built as shown in the four steps on the next page.



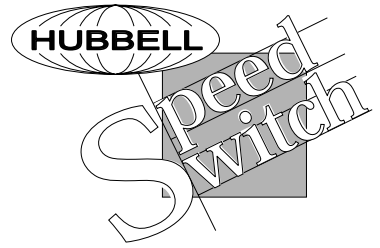

Catalog Number Breakdown

The catalog numbers shown below are for example purposes.

Type of Switch		NEMA Rating
PRS-031		F
<p>Switch Type</p> <p>PRS-031 Non-directional snap action SPDT-2 NO/2 NC AC contacts PRD-031 Non-directional snap action SPDT-2 NO/2 NC DC contacts PRS-038M Non-directional snap action SPDT-2 NO/2 NC AC manually reset contacts PRS-0318 AC wide range setting PRD-0318 DC wide range setting</p>	<p style="text-align: center;">1 1</p> <hr/> <p>Flyweight Type</p> <p>0 – Extra Heavy 1 – Heavy 2 – Medium 3 – Medium Light 4 – Light</p> <p style="text-align: center;">Spring Type</p> <p>1 – Light 2 – Heavy</p>	<p>Enclosures</p> <p>No-Suffix NEMA 1 Gasketed (standard) E Rear shaft extension (flat on shaft) F Flange mounting WP Weather proof - NEMA 3R EX9 Rear shaft extension with key way</p>

Type of Switch	NEMA Rating	Options
2220- 1 1 1 CC	13	S
<p>Switch Type</p> <p>2210 – Centrifugal action flyweight type 2220 – Fluid/Eddy Current type</p> <p>Flyweight type – 2210</p> <p>1 – Heavy 2 – Medium 3 – Light 4 – Extra light</p> <p>Rotor Code – 2220</p> <p>1 – Standard 2 – Press application</p> <p>Spring Type</p> <p>1 – Heavy 2 – Medium 3 – Light 4 – Ex: Light 5 – Wide Range (Heavy) 6 – Wide Range (Light)</p> <p>Contact Type – 2210</p> <p>2 – Snap Action, AC (Non-directional) 3 – Snap Action, DC (Non-directional)</p> <p>Contact Type – 2220</p> <p>1 – Directional 2 – CCW Activation Only } Viewed from shaft 3 – CW Activation Only } end of switch</p> <p>Contacts</p> <p>C – NO/NC (SPDT) D – 2NO/2NC (DPDT-2210 only)</p>	<p>Enclosure NEMA</p> <p>4 – Water Tight 7 – Explosion-proof Class 1 Groups C or D 9 – Explosion-proof Class 2 Groups E, F or G; Div. 1 or 2 13 – Industrial use (standard)</p>	<p>Optional Features</p> <p>F – Flange mounting (n/a NEMA 4) S – Single speed increaser (2.94 to 1) SS – Double speed increaser (8.64 to 1) M – 1 manual reset (AC only) MM – 2 manual reset (AC only)</p>

This section of the part number is determined by the user's speed selection and is only provided for informational purposes.

Ordering Example

<p>1. Using the table we identify a 2210-312CCx meets our requirements for speed range, contacts and directional requirements. (See Page 13)</p>	<p>3. The options we required were flange mounting and manual reset which are both available.</p> <p style="text-align: center;">2210-312CC13 F M</p> <p style="text-align: center;">Flange Mounted Manual Reset</p>
<p>2. The NEMA enclosure required is just a standard configuration – NEMA 13. Replacing the "x" this gives us the following catalog number:</p> <p style="text-align: center;">2210-312CC13</p> <p style="text-align: center;">Enclosure Type</p>	<p>4. Complete catalog number – 2210-312CC13FM</p> <p>Refer to Price List 2200 for price of speed switch. Consult with factory if catalog number does not appear in the price list.</p>

Selection Guides

Type 2200

Application	Maximum Running Speed	Contact Adjustment Range ¹				Contacts ²		Catalog Number
		Min. RPM		Max. RPM		Left Hand	Right Hand	
		Asc.	Desc.	Asc.	Desc.			
AC Snap-Action Non-Directional Contacts								
Overspeed or Underspeed Detection	1800	100	65	180	140			2200-PRS-031-01
	2000	115	85	210	170		2200-PRS-031-11	
	3600	185	140	330	280		2200-PRS-031-21	
	3600	250	200	800	680		2200-PRS-031-22	
	3600	420	350	1500	1370		2200-PRS-031-32	
	3600	800	650	2800	2600		2200-PRS-031-42	
	4000	1550	1250	4000	3220		2200-PRS-031-52	
DC Snap-Action Non-Directional Contacts								
Overspeed or Underspeed Detection	1800	115	70	180	135			2200-PRS-031-01
	2000	130	90	210	160		2200-PRS-031-11	
	3600	200	150	340	250		2200-PRS-031-21	
	3600	300	190	760	630		2200-PRS-031-22	
	3600	640	420	1700	1300		2200-PRS-031-32	
	3600	950	670	3000	2320		2200-PRS-031-42	
	4000	1600	1130	4000	3090		2200-PRS-031-52	
Manually Reset AC Snap-Action Non-Directional Contacts								
Overspeed Detection	1800	115		180				2200-PRS-038M-01
	2000	130		210			2200-PRS-038M-11	
	3600	200		340			2200-PRS-038M-21	
	3600	300		760			2200-PRS-038M-22	
	3600	640		1700			2200-PRS-038M-32	
	3600	950		3000			2200-PRS-038M-42	
	4000	1600		4000			2200-PRS-038M-52	

Optional Features	Description
WP	Weatherproof – NEMA 3R
WT	Watertight – NEMA 4
XA	NEMA 7 Explosion Proof Class 1, Group D
XBP	NEMA 9 Explosion Proof Class 2, Group E, F or G
XB/XC/XD/XE	NEMA 10 Explosion Proof MSHA Approved
F	Flange Mounting (NEMA 1 switches only)
E	Rear Shaft Extension 0.3939"ø x 1.25" (NEMA 1 switches only)
EX9	Rear Shaft Extension with Keyway

When selecting options for the Series 2200, first determine which switch your application requires from the table above. Then from the table left determine which type of housing you require. If the housing you selected is NEMA 1, the determine if the additional options of flange mounting and read shaft extension are necessary.

See page 16 for all footnote and general notes. Contact factory for optional feature not shown.



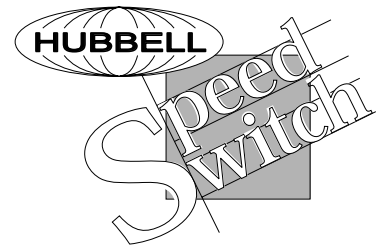

Type 2210

Application	Maximum Running Speed	Contact Adjustment Range ¹		Contacts ²		Catalog Number	NEMA Rating	Options	Notes
		Min. RPM Asc.	Max. RPM Desc.	Left Hand	Right Hand				
Snap-Action – Precision Switch Type Non-Directional Contacts – AC Voltage									
Overspeed or underspeed protection	208	10	9	49	47	2210-142CCxSS	4,7,9,13	M,MM	9,10
	208	14	10	68	64	2210-132CCxSS	4,7,9,13	M,MM	9,10
	463	15	11	87	80	2210-232CCxSS	4,7,9,13	M,MM	9,10
	463	22	19	150	133	2210-222CCxSS	4,7,9,13	M,MM	9,10
	612	31	26	145	139	2210-142CCxS	4,7,9,10,13	F,M,MM	9,10,11
	612	41	29	201	187	2210-132CCxS	4,7,9,10,13	F,M,MM	9,10,11
	1361	44	32	255	235	2210-232CCxS	4,7,9,10,13	F,M,MM	9,10,11
	1361	65	54	442	391	2210-222CCxS	4,7,9,10,13	F,M,MM	9,10,11
	1800	90	75	425	410	2210-142CCx	4,7,9,10,13	F,M,MM	9,11
	1800	120	85	590	550	2210-132CCx	4,7,9,10,13	F,M,MM	9,11
	4000	130	95	750	690	2210-232CCx	4,7,9,10,13	F,M,MM	9,11
	4000	190	160	1300	1150	2210-222CCx	4,7,9,10,13	F,M,MM	9,11
	5000	470	315	3700	3500	2210-312CCx	4,7,9,10,13	F,M,MM	9,11
	Snap-Action – Precision Switch Type Non-Directional Contacts – DC Voltage								
Overspeed or underspeed protection	208	19	13	81	67	2210-133CCxSS	4,7,9,13		9,10
	463	26	16	87	71	2210-233CCxSS	4,7,9,13		9,10
	463	29	20	156	130	2210-223CCxSS	4,7,9,13		9,10
	612	56	39	238	196	2210-133CCxS	4,7,9,10,13	F	9,10
	1361	77	46	255	207	2210-233CCxS	4,7,9,10,13	F	9,10
	1361	85	60	459	381	2210-223CCxS	4,7,9,10,13	F	9,10
	1800	165	115	700	575	2210-133CCx	4,7,9,10,13	F	9
	4000	225	135	750	610	2210-233CCx	4,7,9,10,13	F	9
	4000	250	175	1350	1120	2210-223CCx	4,7,9,10,13	F	9
	5000	520	390	3600	3250	2210-313CCx	4,7,9,10,13	F	9

Note: Replace "X" in catalog number with NEMA enclosure type (4, 7, 9, 10 or 13).

Optional Feature	Description
F	Flange mounting
M	1 manual reset contact (AC only)
MM	2 manual reset contacts (AC only)

When selecting options for the Series 2210 switches, first determine which switch your application requires from the table on this page. Then determine which type housing and mounting configuration you require. The only mounting configurations available for most switches are – "surface mounting" or "flange mounting". The standard configuration is "surface mounting". If the switch you selected has AC SPST contacts, you can additionally select whether you want single or double manual reset buttons. **NEMA 4 Flange mounting is not available.**

See page 16 for all footnotes and general notes. Contact Factory For Optional Features Not Shown.

Selection Guides

Type 2220

Application	Maximum Running Speed	Contact Adjustment Range ¹				Contacts ²		Catalog Number	NEMA Rating	Options	Notes
		Min. RPM Asc.	Min. RPM Desc.	Max. RPM Asc.	Max. RPM Desc.	Left Hand	Right Hand				
Snap-Action – Precision Switch Type – Directional Contacts – AC Voltage											
Motion/Loss of Motion protection	20	1	1	8	5			2220-221CCxSS	4,7,9,13		4,12
	60	2	1	24	14			2220-221CCxS	4,7,9,13	F	4,9,10
	175	7	4	70	42			2220-221CCx	4,7,9,13	F	4,9
	231	1	1	3	2			2220-111CCxSS	4,7,9,13		12
	231	2	1	6	3			2220-121CCxSS	4,7,9,13		12
	680	2	1	8	5			2220-111CCxS	4,7,9,13	F	9,10
	680	5	3	17	10			2220-121CCxS	4,7,9,13	F	9,10
	2000	7	4	23	14			2220-111CCx	4,7,9,13	F	9
	2000	15	9	50	30			2220-121CCx	4,7,9,13	F	9
	Snap-Action – Precision Switch Type – Operate CCW³ Shaft Rotation – AC Voltage										
Motion/Loss of Motion protection	20	2	1	10	7			2220-222CCxSS	4,7,9,13		4,12
	60	4	2	30	20			2220-222CCxS	4,7,9,13	F	4,9,10
	175	13	7	87	59			2220-222CCx	4,7,9,13	F	4,9
	231	2	1	5	3			2220-112CCxSS	4,7,9,13		12
	231	3	1	10	6			2220-122CCxSS	4,7,9,13		12
	680	4	2	14	9			2220-112CCxS	4,7,9,13	F	9,10
	680	7	4	31	18			2220-122CCxS	4,7,9,13	F	9,10
	2000	13	7	42	25			2220-112CCx	4,7,9,13	F	9
2000	22	11	90	54			2220-122CCx	4,7,9,13	F	9	
Snap-Action – Precision Switch Type – Operate CW³ Shaft Rotation – AC Voltage											
Motion/Loss of Motion protection	20	2	1	10	7			2220-223CCxSS	4,7,9,13		4,12
	60	4	2	30	20			2220-223CCxS	4,7,9,13	F	4,9,10
	175	13	7	87	59			2220-223CCx	4,7,9,13	F	4,9
	231	2	1	5	3			2220-113CCxSS	4,7,9,13		12
	231	3	1	10	6			2220-123CCxSS	4,7,9,13		12
	680	4	2	14	9			2220-113CCxS	4,7,9,13	F	9,10
	680	7	4	31	18			2220-123CCxS	4,7,9,13	F	9,10
	2000	13	7	42	25			2220-113CCx	4,7,9,13	F	9
2000	22	11	90	54			2220-123CCx	4,7,9,13	F	9	

Optional Feature	Description
------------------	-------------

F Flange mounting

When selecting options for the Series 2220 switches, first determine which switch your application requires from the table on this page. Then determine which type housing and mounting configuration you require. The only mounting configurations available for most switches are – “surface mounting” or “flange mounting”. The standard configuration is “surface mounting”.

See page 16 for all footnote and general notes. Contact factory for optional feature not shown.



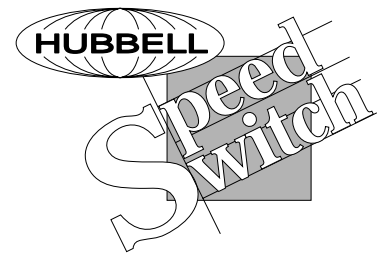

Series 2243

$\frac{3}{8}$ " Shaft Catalog	$\frac{5}{8}$ " Shaft Catalog Number	Maximum Running Speed	Contact Adjustment Range ¹	
			Min RPM	Max RPM

Under Speed Detection⁵ – Non-Directional Contacts

			Desc. Trip	Asc. Speed Adj. Range	Desc. Trip	Asc. Speed Adj. Range
2243-301	3600	0.57	0.60–0.71	4.8	5.1–6.0	
2243-302	3600	3.8	4.0–4.7	16.0	16.9–20.0	
2243-303	3600	14.3	15.0–17.8	48.0	50.6–60.0	
2243-304	3600	47.5	50.0–59.4	240.0	253–300	

Over Speed Detection⁶ – Non-Directional Contacts

		Asc. Trip	Desc. Speed Adj. Range	Asc. Trip	Desc. Speed Adj. Range
2243-311	3600	0.6	0.48–0.57	6.0	4.80–5.70
2243-312	3600	4.0	3.20–3.80	20.0	26.0–19.0
2243-313	3600	15.0	12.0–14.3	60.0	48.0–57.0
2243-314	3600	50.0	40.0–47.5	300.0	240–285

Series 2260

Catalog Number	Maximum Running Speed	Contact Adjustment Range ¹				Mounting
		Min Trip Speed		Max Trip Speed		
		Asc.	Desc.	Asc.	Desc.	

Non-Directional Contacts

2260-021	3600	3.0	2.25	300	225	Surface/Flange
----------	------	-----	------	-----	-----	----------------

Directional Contacts

2260-022	3600	3.0	2.25	300	225	Surface/Flange
----------	------	-----	------	-----	-----	----------------

Series 2310

DC-PNP Part Number	DC-PNP Part Number	AC Part Number	Contact	Speed Range	Housing
48952-101	48953-101	48910-101	NO	6–150	Plastic
48952-102	48953-102	—	NC	6–150	Plastic
48952-103	48953-103	48910-102	NO	150–3600	Plastic
48952-104	48953-104	—	NC	150–3600	Plastic
48952-151	48953-151	48910-151	NO	6–150	Nickel Plated
48952-152	48953-152	—	NC	6–150	Nickel Plated
48952-153	48953-153	48910-152	NO	150–3600	Nickel Plated
48952-154	48953-154	—	NC	150–3600	Nickel Plated

See page 16 for all footnotes and general notes. Contact Factory For Optional Features Not Shown.

Notes

These notes are for pages 12 – 15.

Refer to Price List 2200/2300 or 1201 for pricing information.

Switch contacts may be set for either increasing speed or decreasing speed operation. However, the differential speed is nonadjustable (except for 2243 switches) and subject to mechanical tolerances.

Speed Ranges shown in the table for Series 2210/2220 are for horizontally mounted switches with contacts set for simultaneous operation. Speed Ranges shown in tables on pages 12 – 15 (except 2310) are for horizontal mounted switches. If switches are mounted vertically, consult factory. Switches are for surface mounting (except 2310) unless otherwise specified.

1. Contacts are factory set at minimum descending and minimum ascending speeds as shown. Factory speed set points above minimum are available when specified for a nominal charge.
2. Contact symbols are shown with switch at rest and viewed from the rear.
3. CW-CCW denotes shaft rotation from shaft end of switch.
4. These switches are suited for applications requiring faster than normal pickup and reset times, and are not suitable for high running speeds.
5. Relay de-energizes when descending set point is reached.
6. Relay de-energizes when ascending set point is reached.
7. Includes adapter bracket to provide for mounting in place of a Bulletin 2210 or 2220 Surface Mounting Unit.
8. Specify relay coil voltage and frequency. Available voltages: 110V, 220V, 440V and 550V – 50/60 cycles.
9. Flange Mounting is not available for NEMA 4 rated housing.
10. Flange Mounting is not available for NEMA 7, 9 or 10 rated housings with speed increasers.
11. Manual Reset Buttons are not available for NEMA 10 rated housings.
12. Flange mounting not available on switches with double speed increasers.

Series 2210/20 Mounting Configurations

NEMA Type	Surface Mount	S Surf. Mount w/ Single Speed Increaser	SS Surf. Mount w/ Double Speed Increaser	F Flange Mount	FS Flange Mount w/ Single Speed Increaser
2210 Type C Options					
13	✓	✓	✓	✓	✓
4	✓	✓	✓	—	—
7	✓	✓	✓	✓	—
9	✓	✓	✓	✓	—
10	✓	✓	—	—	—
2220 Type F Options					
13	✓	✓	✓	✓	✓
4	✓	✓	✓	—	—
7	✓	✓	✓	✓	—
9	✓	✓	✓	✓	—

Contact factory for optional feature not shown.



Accessories



Couplings

"A" Input Shaft End	"B" Keyway	Flexible Couplings Part No.
0.5000" - 0.5015"	0.125" x 0.062"	HC30349-000
0.5115" - 0.5120"	0.125 x 0.056"	HC30350-000
0.6250" - 0.6265"	0.094" x 0.053"	HC30490-000
0.6250" - 0.6265"	0.188" x 0.094"	HC30351-000
0.7500" - 0.7515"	0.156" x 0.078"	HC30353-000

Flexible Couplings are available for all shaft driven speed switches and should be used to connect the switch to the drive/input shaft to compensate for minor misalignment. Several input shaft sizes are available.

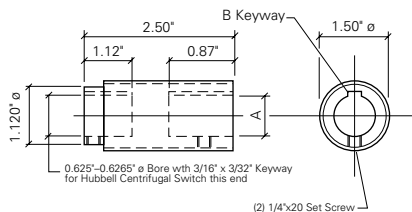

Flexible Coupling

Separate Mounted Gear Boxes

Part No.	Gear Ratio
HC65222-002	2.94 To 1
HC65222-001	8.64 To 1

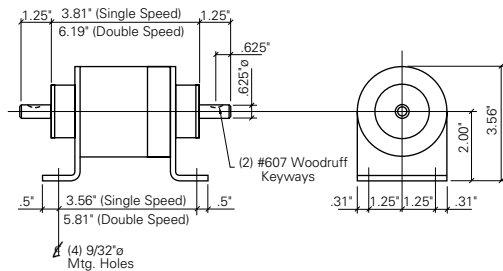

- Can be used with the 2200, 2210, 2220 switches or any other compatible devices. Shimming is necessary for use with the 2200 switches.
- Available as speed increasers or speed reducers with 2.941:1 or 8.64:1 ratios.
- Steel gears
- Designed for heavy duty use
- Flexible couplings are recommend for connecting the gear box to the drive and the speed switch.

Series 2310 Accessories

Part No.	Description
HC48916-001	Jam Nut (Black)
HC48916-002	Jam Nut (Nickel Plated)
HC48943-000	Mounting Bracket

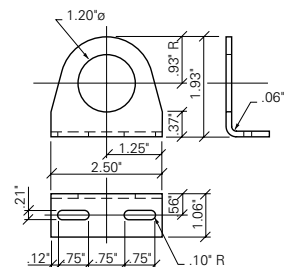
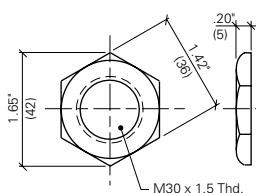

Prices for these items are located in the Accessories Section of Price List 2200/2300

Dimensional Illustrations

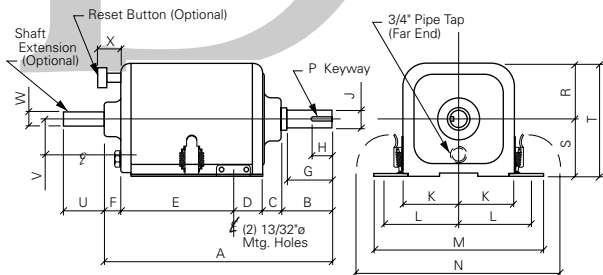

Illustration #1
 Surface Mounting Enclosure – **2200**
 Approx. Weight 12 lbs.
 NEMA 1 Gasketed or NEMA 3R

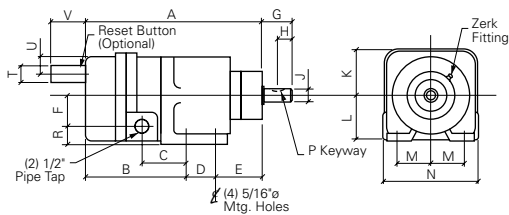

Illustration #3
 Surface Mounting Enclosure – **2210/2220**
 Approx. Weight 4 lbs.
 NEMA 4 or 13

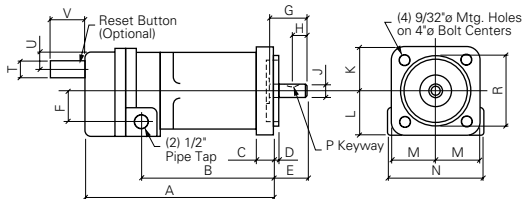

Illustration #5
 Flange Mounting Enclosure – **2210/2220**
 Approx. Weight 5 lbs.
 NEMA 13

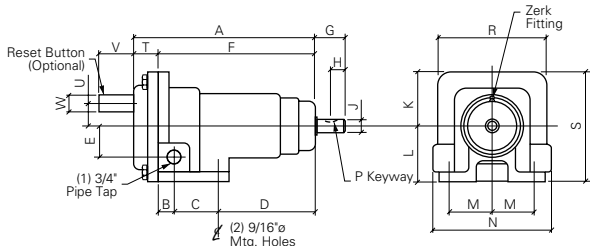

Illustration #7
 Surface Mounting Enclosure – **2210/2220**
 Approx. Weight 11.5 lbs.
 NEMA 7 or 9 with Speed Inserter

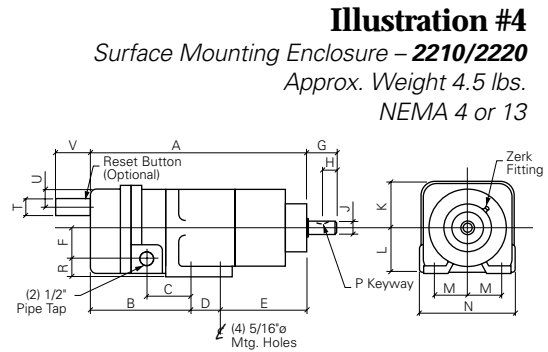

Illustration #4
 Surface Mounting Enclosure – **2210/2220**
 Approx. Weight 4.5 lbs.
 NEMA 4 or 13

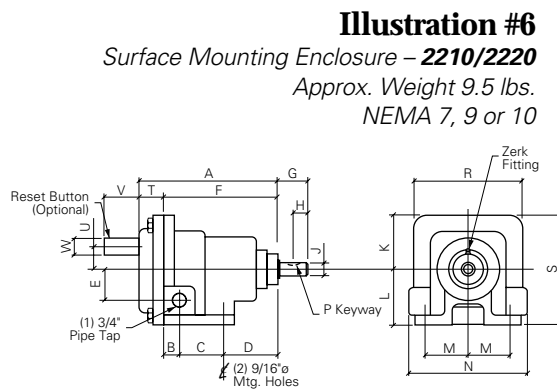

Illustration #6
 Surface Mounting Enclosure – **2210/2220**
 Approx. Weight 9.5 lbs.
 NEMA 7, 9 or 10

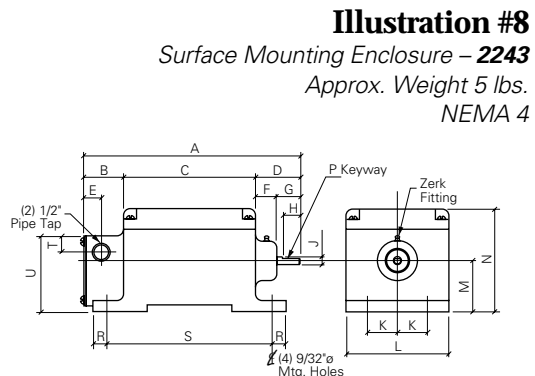

Illustration #8
 Surface Mounting Enclosure – **2243**
 Approx. Weight 5 lbs.
 NEMA 4

See page 20 & 21 for dimensions.

Illustration #9

Surface Mounting Enclosure – **2260**
 Approx. Weight 4 lbs.
 NEMA 13

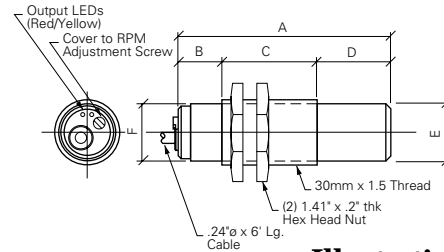
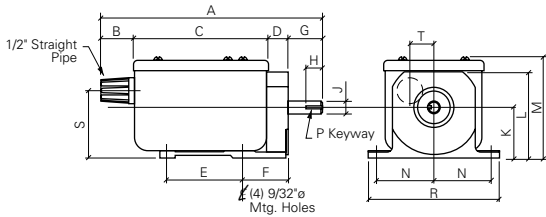

Illustration #10

Surface Mounting Enclosure – **2310**
 Approx. Weight 1 lbs.
 NEMA 4X or 13

Illustration #11

Flange Mounting Enclosure – **2210/2220**
 Approx. Weight 11.5 lbs.
 NEMA 7 or 9

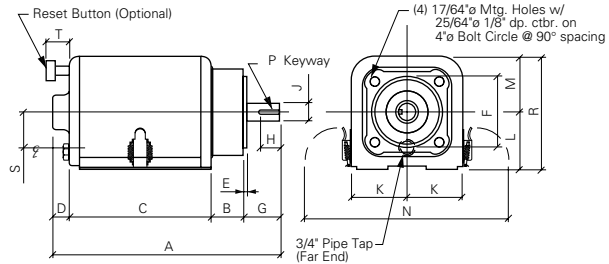
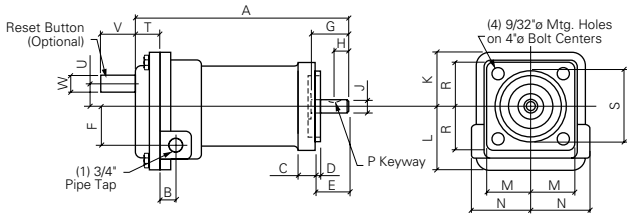
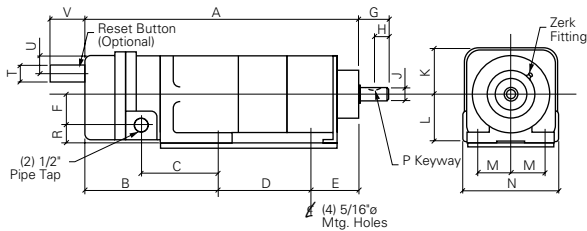

Illustration #12

Flange Mounting Enclosure – **2200**
 Approx. Weight 13.5 lbs.
 NEMA 1 Gasketed

Illustration #13

Surface Mounting Enclosure – **2210/2220**
 Approx. Weight 5.5 lbs.
 NEMA 4 or 13



Notes:

For pages 18 – 21

1. All dimensions are in inches unless noted otherwise. Available options titles are "Res But" – Reset Button, "Sft Ext" – Shaft Extension, "Zrk Fit" – Zerk Fitting and "Cond Con" – Conduit Connection and Lock Screw.
2. The notes listed below are for size of conduit connection supplied on speed switches and appear on the tables on pages 20 & 21.
 - (1) 1-1/8" x 12NF Thread 1/2" Ent.
 - (2) 1" x 14NF Thread 7/16" Ent.
 - (3) 1-1/8" x 12NF Thread 5/8" Ent.
 - (4) 1-1/8" x 12NF Thread 3/4" Ent.

Dimensions

Part Number	NEMA Type	Illus. No.	Dimensions										
			A	B	C	D	E	F	G	H	J	K	L
PRx-xxx-xx	1	1	7.78	1.47	0.34	1.16	4.31	0.50	1.25	0.88	0.63	2.63	1.50
-xxx-xxE	1	1	7.78	1.47	0.34	1.16	4.31	0.50	1.25	0.88	0.63	2.63	1.50
-xxx-xxF	1	12	7.78	0.84	5.47	0.50	0.19	3.00	0.97	0.88	0.63	2.63	2.75
-xxx-xxWP	3R	1	7.78	1.47	0.34	1.22	4.25	0.50	1.25	0.88	0.63	2.63	3.06
PRS-038M-xx	1	1	7.78	1.47	0.34	1.16	4.31	0.50	1.25	0.88	0.63	2.63	1.50
-038M-xxE	1	1	7.78	1.47	0.34	1.16	4.31	0.50	1.25	0.88	0.63	2.63	1.50
-038M-xxF	1	12	7.78	0.84	5.47	0.50	0.19	3.00	0.97	0.88	0.63	2.63	2.75
2210-xxxxx4	4	3	7.06	4.13	2.19	1.38	1.56	1.31	1.31	0.63	0.63	1.78	2.00
-xxxxx4S	4	4	9.25	4.13	2.19	1.38	3.75	1.31	1.25	0.63	0.63	1.78	2.00
-xxxxx4SS	4	13	11.50	5.50	3.56	2.69	3.31	1.31	1.25	0.63	0.63	1.78	2.00
-xx2xx4M	4	3	7.06	4.13	2.19	1.38	1.56	1.31	1.31	0.63	0.63	1.78	2.00
-xx2xx4SM	4	4	9.25	4.13	2.19	1.38	3.75	1.31	1.25	0.63	0.63	1.78	2.00
-xx2xx4SSM	4	13	11.50	5.50	3.56	2.69	3.31	1.31	1.25	0.63	0.63	1.78	2.00
-xxxxx7	7, Class 1	6	6.63	1.13	2.25	2.81	1.38	6.19	1.25	0.63	0.63	2.69	3.06
-xxxxx7S	7, Class 1	7	10.00	1.13	2.25	5.19	1.38	8.56	1.25	0.63	0.63	2.69	3.06
-xxxxx7F	7, Class 1	11	8.95	1.06	0.50	0.19	1.00	1.38	1.19	0.63	0.63	2.69	3.06
-xx2xx7M	7, Class 1	6	6.63	1.13	2.25	2.81	1.38	6.19	1.25	0.63	0.63	2.69	3.06
-xx2xx7FM	7, Class 1	11	8.95	1.06	0.50	0.19	1.00	1.38	1.19	0.63	0.63	2.69	3.06
-xx2xx7SM	7, Class 1	7	10.00	1.13	2.25	5.19	1.38	8.56	1.25	0.63	0.63	2.69	3.06
-xxxxx9	9, Class 2	6	7.69	1.13	2.25	2.88	1.38	6.25	1.19	0.63	0.63	2.69	3.06
-xxxxx9S	9, Class 2	7	10.63	1.13	2.25	5.81	1.38	9.19	1.25	0.63	0.63	2.69	3.06
-xxxxx9F	9, Class 2	11	8.95	1.06	0.50	0.19	1.00	1.38	1.19	0.63	0.63	2.69	3.06
-xx2xx9M	9, Class 2	6	7.69	1.13	2.25	2.88	1.38	6.25	1.19	0.63	0.63	2.69	3.06
-xx2xx9FM	9, Class 2	11	8.95	1.06	0.50	0.19	1.00	1.38	1.19	0.63	0.63	2.69	3.06
-xx2xx9SM	9, Class 2	7	10.63	1.13	2.25	5.81	1.38	9.19	1.25	0.63	0.63	2.69	3.06
-xxxxx10	10	6	7.75	1.13	2.25	2.81	1.38	6.19	1.25	0.63	0.63	2.69	3.06
-xxxxx10S	10	7	10.13	1.13	2.25	5.19	1.38	8.56	1.25	0.63	0.63	2.69	3.06
-xxxxx13	3, 13	3	6.38	4.13	2.19	1.38	0.88	1.31	1.25	0.63	0.63	1.78	2.00
-xxxxx13F	3, 13	5	6.69	4.75	0.50	0.19	0.94	1.31	1.25	0.63	0.63	1.88	1.88
-xxxxx13FS	3, 13	5	9.13	7.19	0.88	0.19	0.88	1.31	1.19	0.63	0.63	1.88	1.88
-xxxxx13S	3, 13	4	8.63	4.13	2.19	1.38	3.13	1.31	1.25	0.63	0.63	1.78	2.00
-xxxxx13SS	3, 13	13	10.94	5.50	3.56	2.69	2.75	1.31	1.25	0.63	0.63	1.78	2.00
-xx2xx13M	3, 13	3	6.38	4.13	2.19	1.38	0.88	1.31	1.25	0.63	0.63	1.78	2.00
-xx2xx13FM	3, 13	5	6.69	4.75	0.50	0.19	0.94	1.31	1.25	0.63	0.63	1.88	1.88
-xx2xx13FSM	3, 13	5	9.13	7.19	0.88	0.19	0.88	1.31	1.19	0.63	0.63	1.88	1.88
-xx2xx13SM	3, 13	4	8.63	4.13	2.19	1.38	3.13	1.31	1.25	0.63	0.63	1.78	2.00
-xx2xx13SSM	3, 13	13	10.94	5.50	3.56	2.69	2.75	1.31	1.25	0.63	0.63	1.78	2.00
2220-xxxxx4	4	3	7.06	4.13	2.19	1.38	1.56	1.31	1.31	0.63	0.63	1.78	2.00
-xxxxx4S	4	4	9.25	4.13	2.19	1.38	3.75	1.31	1.25	0.63	0.63	1.78	2.00
-xxxxx4SS	4	13	11.50	5.50	3.56	2.69	3.31	1.31	1.25	0.63	0.63	1.78	2.00
-xxxxx7	7, Class 1	6	7.75	1.13	2.25	2.81	1.38	6.19	1.25	0.63	0.63	2.69	3.06
-xxxxx7S	7, Class 1	7	10.13	1.13	2.25	5.19	1.38	8.56	1.25	0.63	0.63	2.69	3.06
-xxxxx7F	7, Class 1	11	8.95	1.06	0.50	0.19	1.00	1.38	1.19	0.63	0.63	2.69	3.06
-xxxxx9	9, Class 2	6	7.81	1.13	2.25	2.88	1.38	6.25	1.19	0.63	0.63	2.69	3.06
-xxxxx9S	9, Class 2	7	10.75	1.13	2.25	5.81	1.38	9.19	1.25	0.63	0.63	2.69	3.06
-xxxxx9F	9, Class 2	11	8.95	1.06	0.50	0.19	1.00	1.38	1.19	0.63	0.63	2.69	3.06
-xxxxx13	3, 13	3	6.38	4.13	2.19	1.38	0.88	1.31	1.25	0.63	0.63	1.78	2.00
-xxxxx13F	3, 13	5	6.69	4.75	0.50	0.19	0.94	1.31	1.25	0.63	0.63	1.88	1.88
-xxxxx13FS	3, 13	5	9.13	7.19	0.88	0.19	0.88	1.31	1.19	0.63	0.63	1.88	1.88
-xxxxx13S	3, 13	4	8.63	4.13	2.19	1.38	3.13	1.31	1.25	0.63	0.63	1.78	2.00
-xxxxx13SS	3, 13	13	10.94	5.50	3.56	2.69	2.75	1.31	1.25	0.63	0.63	1.78	2.00
Series 2243	4	8	9.19	1.63	5.88	1.69	0.81	0.75	0.94	0.75	0.63	2.00	4.75
Series 2260	13	9	8.64	0.94	5.76	0.94	3.63	1.75	1.00	0.50	0.62	2.00	3.19
Series 2310	4X,13	10	3.93	0.68	1.96	1.28	1.06	1.10	—	—	—	—	—

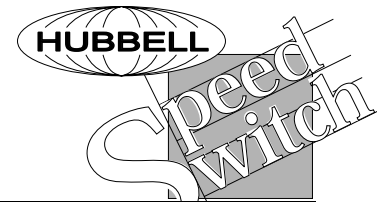

See page 19 for notes. See page 18 & 19 for illustrations.

M	N	P	Dimensions							Res But	Sft Ext	Zrk Fit	Cond Con	Part Number
			R	S	T	U	V	W	X					
—	8.75	3/16" x 3/32"	2.50	2.75	5.25	—	1.56	—	—					PRx-xxx-xx
—	8.75	3/16" x 3/32"	2.50	2.75	5.25	1.25	1.56	0.39	—		✓			-xxx-xxE
2.50	8.75	3/16" x 3/32"	5.25	1.56	—	—	—	—	—					-xxx-xxF
7.13	8.75	3/16" x 3/32"	2.50	2.75	5.25	—	1.56	—	—					-xxx-xxWP
<hr/>														
—	8.75	3/16" x 3/32"	2.50	2.75	5.25	—	1.56	—	1.25	✓				PRS-038M-xx
—	8.75	3/16" x 3/32"	2.50	2.75	5.25	1.25	1.56	0.39	1.25	✓	✓			-038M-xxE
2.50	8.75	3/16" x 3/32"	5.25	1.56	1.13	—	—	—	—	✓				-038M-xxF
<hr/>														
1.25	4.44	#607 Wood.	0.69	—	—	—	—	—	—			✓		2210-xxxxx4
1.25	4.44	#607 Wood.	0.69	—	—	—	—	—	—			✓		-xxxxx4S
1.25	4.44	#607 Wood.	0.69	—	—	—	—	—	—			✓		-xxxxx4SS
1.25	4.44	#607 Wood.	0.69	—	1.00	1.31	1.81	—	—	✓		✓		-xx2xx4M
1.25	4.44	#607 Wood.	0.69	—	1.00	1.31	1.81	—	—	✓		✓		-xx2xx4SM
1.25	4.44	#607 Wood.	0.69	—	1.00	1.31	1.81	—	—	✓		✓		-xx2xx4SSM
2.13	6.13	#607 Wood.	5.38	5.75	1.44	—	—	—	—					-xxxxx7
2.13	6.13	#607 Wood.	5.38	5.75	1.44	—	—	—	—					-xxxxx7S
1.88	3.06	#607 Wood.	1.88	3.00	1.44	—	—	—	—					-xxxxx7F
2.13	6.13	#607 Wood.	5.38	5.75	1.44	1.88	1.81	1.00	—	✓				-xx2xx7M
1.88	3.06	#607 Wood.	1.88	3.00	1.44	1.88	1.81	1.00	—	✓				-xx2xx7FM
2.13	6.13	#607 Wood.	5.38	5.75	1.44	1.88	1.81	1.00	—	✓				-xx2xx7SM
2.13	6.13	#607 Wood.	5.38	5.75	1.44	—	—	—	—			✓		-xxxxx9
2.13	6.13	#607 Wood.	5.38	5.75	1.44	—	—	—	—			✓		-xxxxx9S
1.88	3.06	#607 Wood.	1.88	3.00	1.44	—	—	—	—					-xxxxx9F
2.13	6.13	#607 Wood.	5.38	5.75	1.44	1.88	1.81	1.00	—	✓		✓		-xx2xx9M
1.88	3.06	#607 Wood.	1.88	3.00	1.44	1.88	1.81	1.00	—	✓				-xx2xx9FM
2.13	6.13	#607 Wood.	5.38	5.75	1.44	1.88	1.81	1.00	—	✓		✓		-xx2xx9SM
2.13	6.13	#607 Wood.	5.38	5.75	1.56	—	—	—	—			✓		-xxxxx10
2.13	6.13	#607 Wood.	5.38	5.75	1.56	—	—	—	—			✓		-xxxxx10S
1.25	4.44	#607 Wood.	0.69	—	—	—	—	—	—					-xxxxx13
1.88	4.44	#607 Wood.	3.00	—	—	—	—	—	—					-xxxxx13F
1.88	4.44	#607 Wood.	3.00	—	—	—	—	—	—					-xxxxx13FS
1.25	4.44	#607 Wood.	0.69	—	—	—	—	—	—					-xxxxx13S
1.25	4.44	#607 Wood.	0.69	—	—	—	—	—	—					-xxxxx13SS
1.25	4.44	#607 Wood.	0.69	—	1.00	1.31	1.81	—	—	✓				-xx2xx13M
1.88	4.44	#607 Wood.	3.00	—	1.00	1.31	1.81	—	—	✓				-xx2xx13FM
1.88	4.44	#607 Wood.	3.00	—	1.00	1.31	1.81	—	—	✓				-xx2xx13FSM
1.25	4.44	#607 Wood.	0.69	—	1.00	1.31	1.81	—	—	✓				-xx2xx13SM
1.25	4.44	#607 Wood.	0.69	—	1.00	1.31	1.81	—	—	✓				-xx2xx13SM
<hr/>														
1.25	4.44	#607 Wood.	0.69	—	—	—	—	—	—			✓		2220-xxxxx4
1.25	4.44	#607 Wood.	0.69	—	—	—	—	—	—			✓		-xxxxx4S
1.25	4.44	#607 Wood.	0.69	—	—	—	—	—	—			✓		-xxxxx4SS
2.13	6.13	#607 Wood.	5.38	5.75	1.56	—	—	—	—					-xxxxx7
2.13	6.13	#607 Wood.	5.38	5.75	1.56	—	—	—	—					-xxxxx7S
1.88	3.06	#607 Wood.	1.88	3.00	1.44	—	—	—	—					-xxxxx7F
2.13	6.13	#607 Wood.	5.38	5.75	1.56	—	—	—	—			✓		-xxxxx9
2.13	6.13	#607 Wood.	5.38	5.75	1.56	—	—	—	—			✓		-xxxxx9S
1.88	3.06	#607 Wood.	1.88	3.00	1.44	—	—	—	—					-xxxxx9F
1.25	4.44	#607 Wood.	0.69	—	—	—	—	—	—					-xxxxx13
1.88	4.44	#607 Wood.	3.00	—	—	—	—	—	—					-xxxxx13F
1.88	4.44	#607 Wood.	3.00	—	—	—	—	—	—					-xxxxx13FS
1.25	4.44	#607 Wood.	0.69	—	—	—	—	—	—					-xxxxx13S
1.25	4.44	#607 Wood.	0.69	—	—	—	—	—	—					-xxxxx13SS
<hr/>														
2.00	4.31	1/32" Flat	0.38	6.63	0.88	3.19	—	—	—					Series 2243
<hr/>														
4.10	2.34	3/16" sq.	5.19	2.75	0.85	—	—	—	—					Series 2260
<hr/>														
—	—	—	—	—	—	—	—	—	—					Series 2310

NOTE: Dimensions are approximate. Contact factory for official outline drawings.

Miscellaneous Information

Series 2200

Enclosure

The frame and end plate are cast iron, accurately machined and provided with sealed and permanently lubricated precision ball bearings in which the shaft rotates. The steel shaft is hardened and ground for extreme accuracy and carries the flyweight and contact actuation assembly. Lateral motion of the flyweights is transmitted to the contact actuation assembly through a sealed and permanently lubricated precision thrust ball bearing.

The heavy gauge sheet steel cover is provided with a gasket to make the enclosure semi-dust tight and oil resistant. NEMA Type 1 Gasketed. The cover is secured to the frame by means of two spring latches which keep the gasket under pressure at all times but yet the cover can be removed easily without the use of tools.

Contacts

The contact compartment provides several basic contact arrangements as required for various applications. Slow-action butt type bridging contacts for rapid speed change conditions or snap-action precision contacts for slow speed changes can be supplied.

Type PRS-031 is equipped with single pole double throw snap action contacts from which one normally open and one normally closed contact with common feed are available. At the point of contact actuation, the normally open contact closes and the normally closed contact opens on ascending speed and visa versa on descending speed.

Type PRD-031 is equipped with two snap action contacts designed for use on DC control circuits since the contacts are equipped with a permanent magnet blowout and are provided with one normally open and one normally closed contact. The contacts of this switch are suitable for operation at 250 volts DC maximum.

Series 2210

Enclosure

Standard Type C centrifugal switch housings are molded of tough fiberglass reinforced polyester resin, for the flyweight compartment, and a cast aluminum housing for the contact compartment. The standard molded housings are resistant to most acid, alkali and salt compounds.

When flange-mounting is specified, the flange and the flyweight section of the housing are precisely machined from a single aluminum casting.

NEMA Type 4 enclosures (watertight) for indoor/outdoor applications are furnished with a double shaft seal & grease fitting for lubrication and purging ensuring longer bearing life.

NEMA Type 8, 9 and 10 explosion proof enclosures are available also. These enclosures have precisely machined cast aluminum housings, either for surface or flange mounting.

Speed Adjustment

Speed points at which contacts operate are easily adjustable in the field within the standard operating ranges. Switches are factory set at minimum ascending speeds as listed. Other contact settings may be specified as an option. Each set of snap-action or slow-action contacts is independently adjustable from the rear while the switch is rotating. Also the speed setting of both sets of contacts can be changed at the same time by varying the tension on the main adjustment spring with the adjustment nut.

Contacts

The contact compartment provides several basic contact arrangements as required for various applications. Either slow-action butt-type bridging contacts for rapid speed-change conditions, or snap-action contacts, for slow speed changes, can be provided.

One set or two sets of normally open and/or normally closed single-throw contacts – each set independently adjustable – are available in the slow-action type. One set or two sets of normally open and normally closed single-pole, double-throw, snap-action switches are also available, with each set independently adjustable.

These two separate sets of contacts can be adjusted for operation at different speeds so that two separate operations can be controlled from one speed sensing switch. Therefore, it is possible to perform separate functions at two different speeds. A directional sensing form of the switch employs slow-action butt-type bridging contacts in normally open position only.

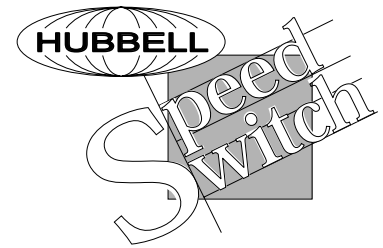

Series 2220

Enclosure

The Type F fluid switch is supplied in a NEMA 13 industrial enclosure to resist lint, dust, seepage, external condensation and spraying of water, oil or coolant. For outdoor or indoor applications susceptible to splashing, or direct water spray, select a NEMA 4 enclosure. For hazardous locations containing explosive gas, NEMA 7, Class I, Group D should be used. NEMA 9, Class II, Group E, F, or G enclosures should be used in hazardous locations containing explosive dust. This design incorporates a double shaft seal to exclude dust particles from the switch interior.

This switch housing is a two part unit, fitted precisely together with tightly gasket joints. The front section encloses the fluid drag assembly and is molded of tough glass fiber reinforced polyester resin. The rear section, which encloses the contact-making compartment, is of cast aluminum. Both housings have ample cross-section to provide very rugged enclosures capable of withstanding shock impact or fracture due to severe service conditions. The aluminum housing is equipped with a grounding screw which provides a means of grounding the shaft to the conduit.

Speed Adjustment

Speed points at which contacts operate are easily adjustable in the field. Switches are factory-set at minimum rpm, but other contact settings may be specified as an option. Type F fluid switch contacts are easily and independently adjustable while running, to compensate for any contact operating variance due to ambient temperature conditions.

The contact compartment houses two single-pole double-throw snap-action switches. Both switches can be factory-assembled to operate in same direction, or one for each direction.

Series 2243

The output of the unit is provided by a single pole double throw plug-in type relay. The relay is located in the forward compartment. The relay contacts are factory wired to the terminal block in the rear compartment for easy customer connections.

On units designated for overspeed application, the relay de-energizes when set point is attained. On units designated for underspeed application, the relay de-energizes when set point is attained. The differential between ascending and descending set points is easily adjusted.

Type D Speed Responsive Switches are designed for reliable operation. In the event of component failure, the output relay reverts to a de-energized position. Long life and high reliability has been designed into these devices through the use of proven integrated circuits, transient voltage protection networks and high quality components. Silicon solid state components are used throughout to assure reliable operation over a wide temperature range.

To represent their durability, these switches are used successfully on automotive punch press applications.

Enclosure

The standard surface mounted enclosure is cast aluminum and is suitable for NEMA and CEMA Type 4.

The main compartment houses and shields the speed adjustment potentiometers, the "light chopping disc" and the chassis. The rear compartment contains the terminals for the input power and output relay connections. Covers for both compartments are provided with gaskets.

The Type D switch is available with either a $\frac{3}{8}$ " diameter shaft which has a flat for set screw securing, or a $\frac{5}{8}$ " diameter shaft which is supplied with a $\frac{3}{16}$ " square key. The shaft is supported by two large, lifetime-lubricated ball bearings for long life and low driving torque.

A grease fitting and double shaft seals are provided. Application of lubricant purges the area between the seals and prevents the penetration of water and abrasive dust.

Series 2260

The Type E Switch is a unitized device containing heavy duty industrial types of sub-modules required to provide consistent, precise, and repetitively accurate response.

The stainless steel input shaft is supported in the enclosure by two permanently sealed and lubricated ball bearings.

Speed Adjustment

The speed point at which the contacts operate is easily adjustable within the standard 3-300 rpm adjustment range. Clockwise rotation of the adjustment pot increases setting, counterclockwise rotation of the adjustment pot decreases setting.

All Type E units are factory set at the minimum ascending trip speed, 3 rpm, unless a specific setting is requested.

Series 2310

The Series 2310 speed responsive switches are available in both 3-wire low DC voltage and 2-wire series load activating AC voltage. Three (3) wire DC units operate either normally closed or normally open transistor outputs that can be either NPN "load sinking" or PNP "load sourcing" versions. All ver-

Miscellaneous Information

sions of these switches are available in a plastic threaded housing or in a plastic housing with a nickel-plated brass threaded sleeve.

Easily recalibrated for "home" position, the Series 2310 permits easy resetting to compensate for belt stretching or slipping on conveyor applications, and for compensatory adjustments on variable speed operations.

In order to sense slower speeds outside the listed ranges, multiple events or actuations per revolution must be used.

Select a mounting area, keeping the Free Zone requirements of non-shielded proximity sensors in mind (see below). The target must move laterally across the face of the speed switch. Actuating distance from the target to the speed switch face is shown in the adjacent figure and table. This information provides an estimated setup distance prior to actual starting.

The speed setting within a given sensor's range is adjustable with the 20-turn RPM adjustment potentiometer located behind the access screw. The ideal location of the speed switch is midway within this operating range.

Series 2310 Setpoint Selection

The Series 2310 speed adjustment ranges are shown in the graph below. The switch is settable on location with just a small screwdriver which is provided. The chart below left shows speed ranges based on single event measurements using a standard target. The speed range is directly related to the sensitivity of

the switch, lateral motion and the material being sampled.

The chart below right shows the effect of lateral motion to the sensing range. Several representative factors for different materials are shown on the bottom right.

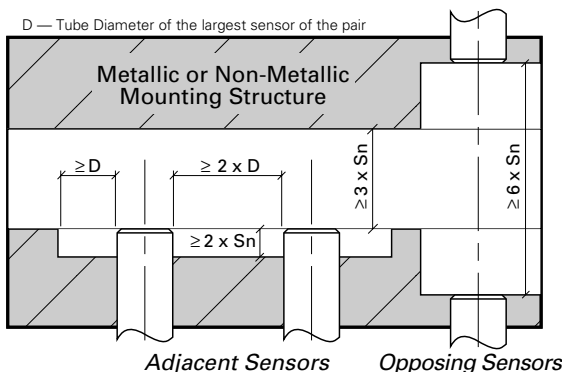
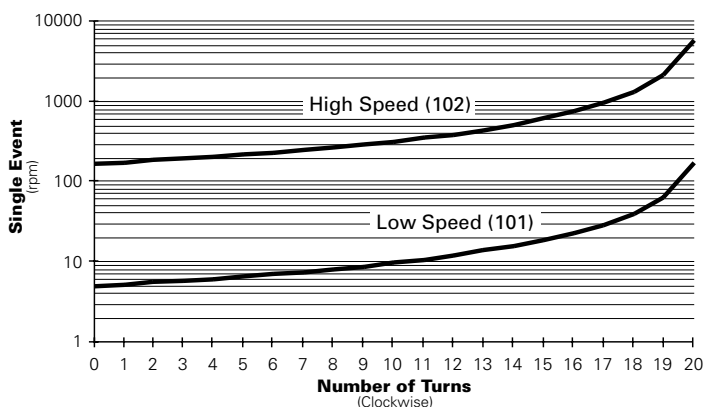
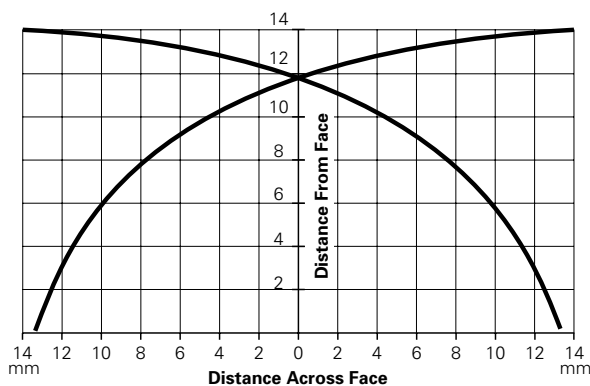

Material Reduction Factors

Based on a 30mm x 30mm x 1.5mm target

Steel	1.0
Stainless Steel	0.7 – 0.8
Aluminum	0.3 – 0.5
Brass	0.3 – 0.4
Copper	0.3 – 0.4



hubbell industrial controls, inc.

Hubbell Industrial Controls, Inc.

a subsidiary of Hubbell Incorporated
 4301 Cheyenne Drive, Archdale, NC 27263
 Phone (336) 434-2800 · Fax (336) 434-2803
 www.hubbell-icd.com
 sales@hubbell-icd.com