

**Allen-Bradley**

The New MCS  
Circuit Breakers  
Bulletin 140M

## Slimline Solutions for Motor Management



Bringing Together Leading Brands in Industrial Automation

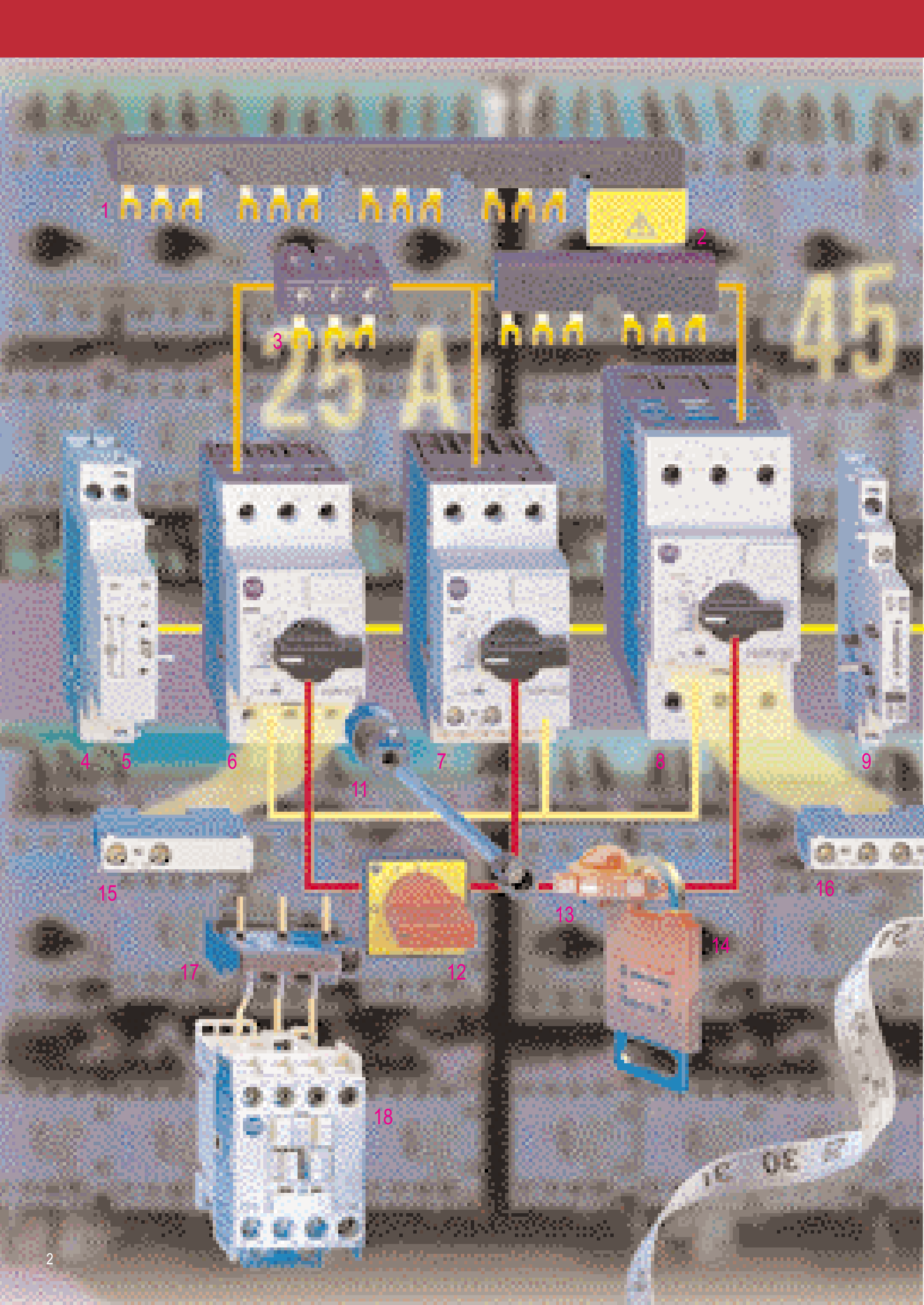

1 000 000 000 000

2

3 000

25 A

000 000

45

4

5

6

7

8

9

11

15

16

17

12

13

14

18

# Slimline Solutions Lead to an New Era in Motor Management



## Slimline solutions make MCS more competitive in the market

- The sophisticated construction and the latest technology of materials of Allen-Bradley's new circuit breakers 140M result in outstanding features and performance.
- High and effective current limiting and an extremely fast disconnection time result in an excellent short circuit breaking capacity, allowing short-circuit co-ordination Type 2 to be achieved automatically with no oversizing of contactors.
- This means you can fit more into your panels with less wasted space.

	0.1	0.16	0.25	0.4	0.63	1.0	1.6	2.5	4.0	6.3	10	16	20	25	32	45	[A]
Motor Protection	Size 1										Size 2						Size 3
	Size 1										Size 2						Size 3
	Size 1										Size 2						Size 3
Starter Protection	Size 1										Size 2						Size 3
	Size 1										Size 2						Size 3
	Size 1										Size 2						Size 3
Transformer Protection	Size 1										Size 2						Size 3
	Size 1										Size 2						Size 3
	Size 1										Size 2						Size 3

The complete range at a glance

Size 1 = High Break  
Size 2 and 3 = High Break PLUS

## Outstanding flexibility due to consistent MCS modularity

- 1 Compact Busbar
- 2 Blank Space Cover
- 3 Busbar Feeder Terminal
- 4 Undervoltage Release
- 5 Voltage Release
- 6 High Break/Size 1
- 7 High Break PLUS/Size 2
- 8 High Break PLUS/Size 3
- 9 Trip Contact
- 10 Auxiliary Contact
- 11 Door Coupling
- 12 Door Coupling Handle
- 13 Lockable Handle
- 14 Locking Arrangement
- 15 Auxiliary Contact
- 16 Combination Trip/Auxiliary Contact
- 17 Connecting Kit for Starters
- 18 MCS Contactor

- Two basic types of circuit breakers for 25 A and 45 A are available in High Break or High Break PLUS versions (Size 1 and 2). Three protection characteristics – Motor Protection (precise overload protection), Starter Protection (short circuit protection only) and Transformer Protection (for high inrush current) – allow the selection of the best suited circuit breaker for the application.
- As with all other MCS components, the new circuit breakers 140M are electrically and dimensionally integrated into the system, this facilitates assembly, handling and logistics.
- The comprehensive range of uniform accessories including the unique front mounted trip/auxiliary contact gives a greater variety and flexibility in signalling and supervising.

- ✓ Protection of installation
- ✓ Protection of circuits
- ✓ Motor protection
- ✓ Starter protection
- ✓ Transformer protection
- ✓ Wide range of ambient temperature compensation
- ✓ Phase failure protection
- ✓ High phase loss sensitivity
- ✓ Easy coordination to back-up selective circuit breaker

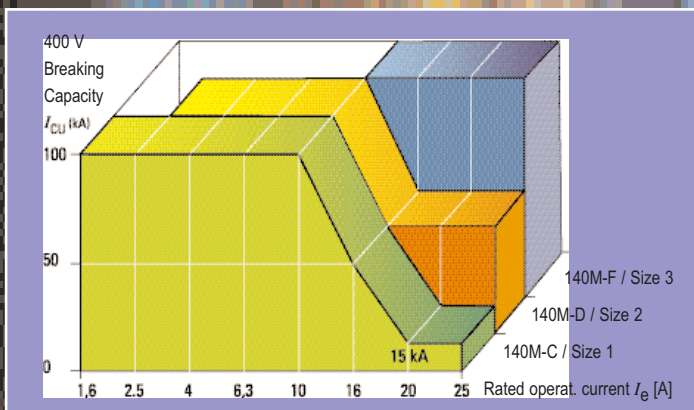

### Comparison Type « 2 » co-ordinated

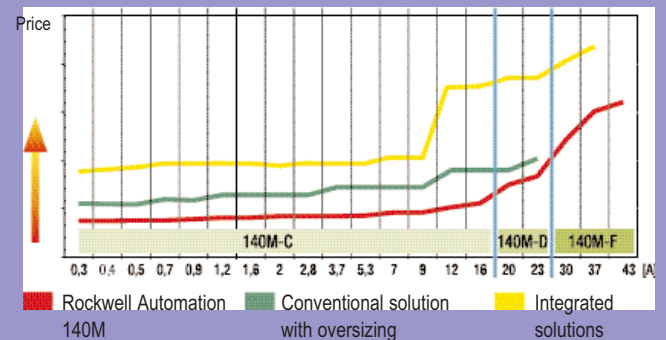

### The breaking champion

- The new circuit breakers 140M set new standards in breaking capacity and current limiting. This results in these benefits:
  - No back-up fuses
  - No current limiters
  - No oversizing of contactors.
- The new circuit breakers 140M can be installed even closer to supply transformers.

### The money saving champion

- With the new circuit breakers 140M you get a superior price/performance ratio compared to other solutions.
- No oversizing of contactors necessary, this makes starters more economical.
- No need for costly integrated starter solutions thanks to the consistent modular concept.
- Compact starters lead to smaller, more economical control cabinets and panels.

# More Functionality in Less Space and at a Lower Cost

140M-D.. 25 A  
High Break PLUS  
Scale 1:1

Base area required by others for the same performance. In the same space needed for 5 other circuit breakers, you place 6 new circuit breakers 140M. A gain of 20 %

Large data labels on both sides with all necessary technical information

Easy mounting onto DIN-rails and onto many special AI-profiles

Large scale for precise setting

Auxiliaries are just snapped on: fast, easy, without tools

Test trip device for checks of the trip mechanism

Open terminals facilitating large cable access save wiring time

Finger safe terminals

Plate for the Allen-Bradley labelling system

Short-circuit indicator provides differentiation between short-circuit and overload trip

Ergonomic handle providing clear status indication ON-OFF-Tripped

Unique front mounted trip/auxiliary contact with no increase of the overall dimensions saves up to 20 % of valuable panel space

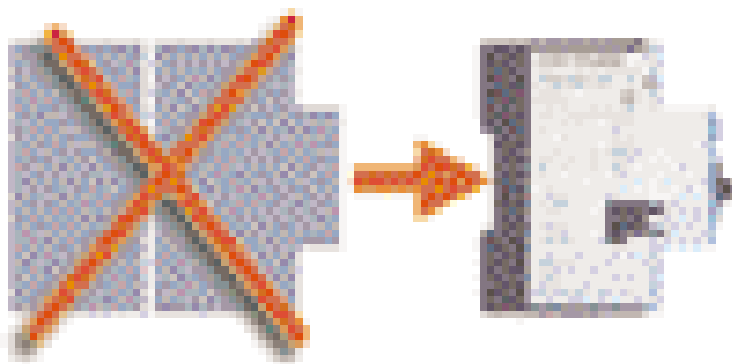

## Type 2 co-ordination is as easy as never before

- Select circuit breaker and contactor simply according to the rated motor current and co-ordination type 2 is automatically given.
- No complicated calculations.
- No uncertainty about the fulfillment of co-ordination type 2.
- Saves time in designing your controls.

## No current limiter needed

- Rationalizes design, saves panel space.
- You can build more economical and smaller panels.
- Compared to competitive solutions, you get up to 20 % higher performance per volume unit.



**Clear information at a glance**

- Clear indication of status.
- Safe and consistent operation.
- One place of indication only, visible on the spot for more safety.
- Robust and powerful jump mechanism leads to more safety and reliability.
- Teaseproof
- Ergonomic handle facilitates operation.
- Enhanced safety; no direct ON switching after a trip. The circuit breaker has to be set OFF first.

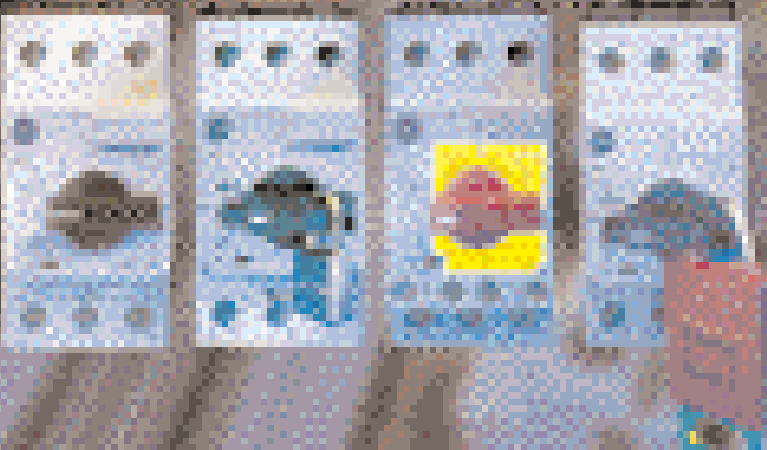

**Lockable rotary handles open wide fields of application**

- Approved for application as:
  - Disconnecter (IEC 947-2)
  - Main Switch (IEC 204-1)
  - Emergency OFF (IEC 204-1)
  - Revision Service Switch (IEC 947).
- No fooling of operation with internal independent free release.

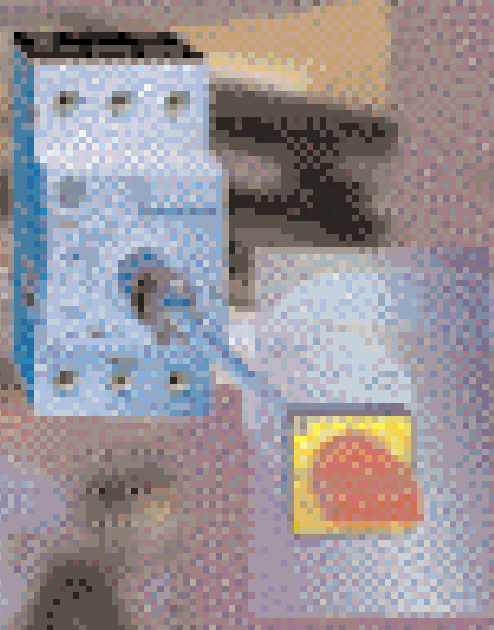

**Door coupling ensures full functionality**

- This practice oriented solution fulfills these important requirements:
  - Exactly the same status indication at the door as on the circuit breaker: OFF, ON and TRIP
  - Door locking, when the circuit breaker is set ON
  - Bypass door locking only with special tool.
- Common look and design of the handles up to 45 kW.

# Smarter Actuation and Status Indication Enhance Operational Safety and Control

## Allen-Bradley 140M

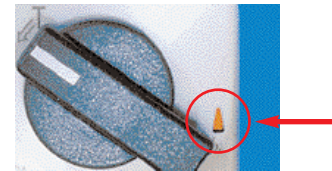

### Short-circuit indicator

- A red flag on the I» window shows that a short-circuit has occurred. This allows the immediate distinction between a short-circuit and an overload trip.
- No waste of time in troubleshooting.

## Other Circuit breakers

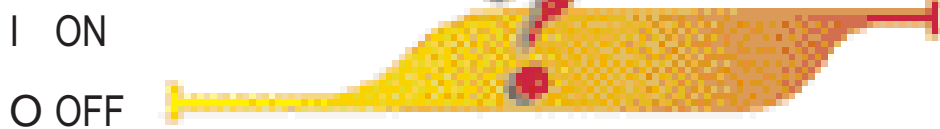

### Manipulation made impossible

- The anti tamper cover prevents unauthorized change of the operational current setting.
- Clear current setting scale, level with the front to avoid unintentional changes.

### Jump mechanism guarantees clear switching status

- The jump mechanism ensures a very fast closing or opening of the contacts, the circuit breaker is either OFF or ON, 140M is teaseproof.

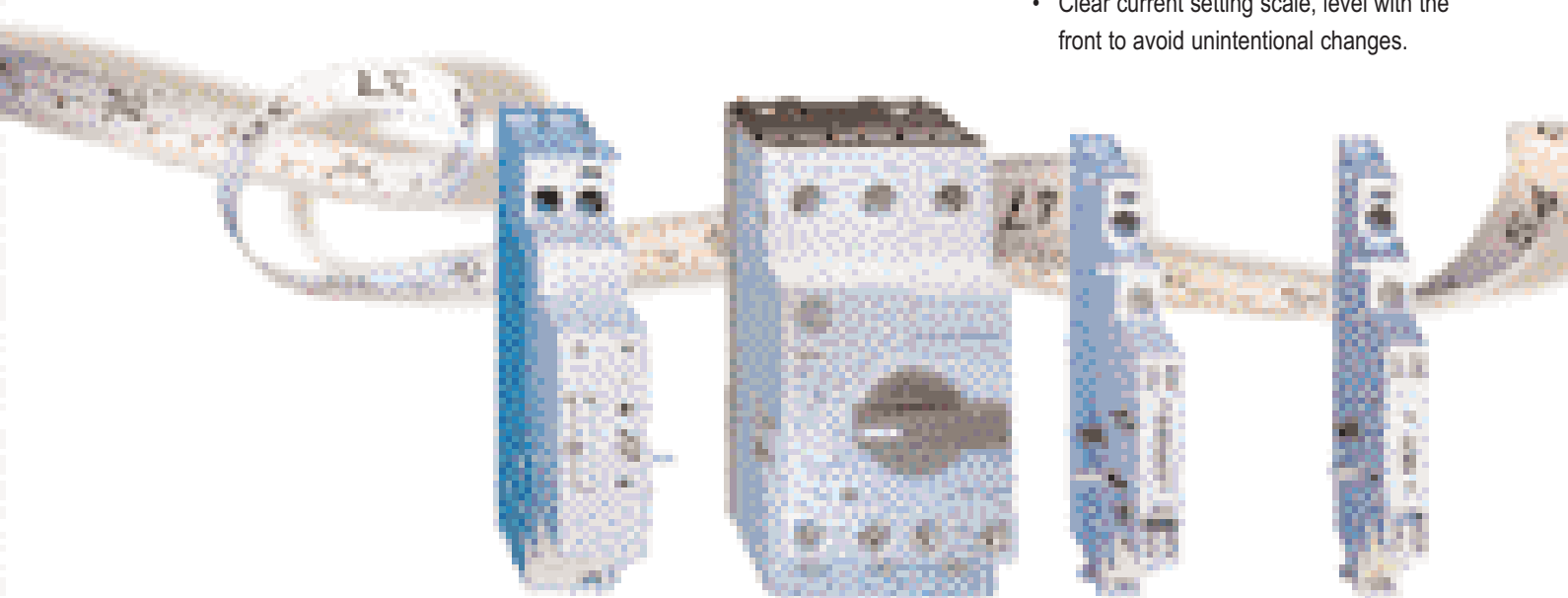

### More indication possibilities

- All different operation and fault conditions can be transmitted by auxiliary contacts.
- The 140M offers more auxiliary combinations than others:
  - Front mounting: 6 variations
  - Side mounting: 8 variations.

### Undervoltage / voltage release

- Undervoltage release
- Undervoltage release with 2 early make contacts
- Voltage release

### Front mounting trip / auxiliary contacts

- 1 N.O. trip / 1 N.O. aux.
- 1 N.O. trip / 1 N.C. aux.

### Front mounting auxiliary contacts

- 1 N.O.
- 1 N.C.
- 1 N.O. / 1 N.C.
- 2 N.O.

### Side mounting trip contacts

- 1 N.O. trip / 1 N.O. trip short-circuit only
- 1 N.O. trip / 1 N.C. trip short-circuit only
- 1 N.C. trip / 1 N.O. trip short-circuit only
- 1 N.C. trip / 1 N.C. trip short-circuit only
- 1 N.O. trip short-circuit only / 1 N.C. trip short-circuit only

### Side mounting auxiliary contacts

- 2 N.O.
- 2 N.C.
- 1 N.O. / 1 N.C.



## Compact mounting allows more compact panels

- Compact mounting side by side saves valuable panel space. No gaps in between required.
- Lowest arcing safety space requirements allow denser layouts.
- No current limiters needed anymore.
- No increase in width thanks to the unique front mounted trip indicator / auxiliary contact. This saves 20 % of panel space.
- With the new circuit breaker 140M you get the most compact solutions.

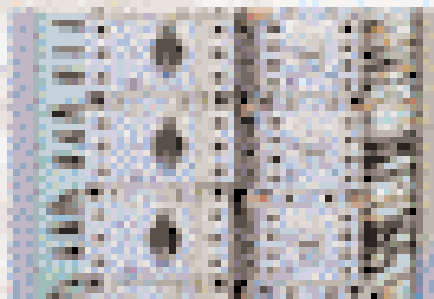
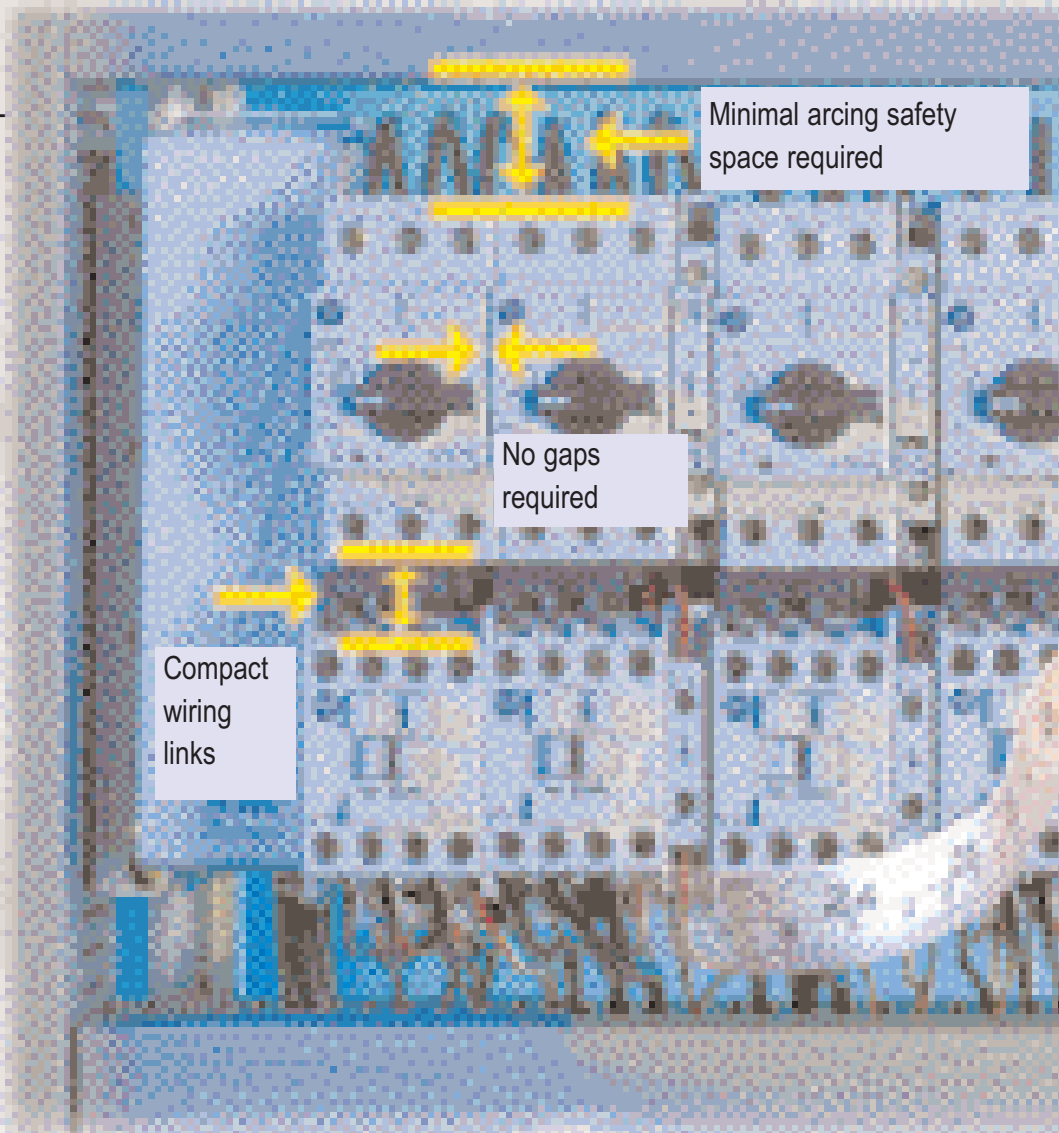

## Faster and easier mounting

- Snaps safely without fixing clip onto standard DIN-rails.
- Complete starter assemblies can be snapped on only one DIN-rail. No mounting distance required behind the rail.

## Vertical mounting saves space

- Vertical mounting allows the optimal positioning of the wiring channels close to the components.

## Auxiliaries easily fitted

- All auxiliaries are added simply by hand. No tools required.
- Unparalleled easy fitting.
- Simple changing even when mounted.



# Compact Dimensions and Easy Handling Save Panel Space and Installation Time

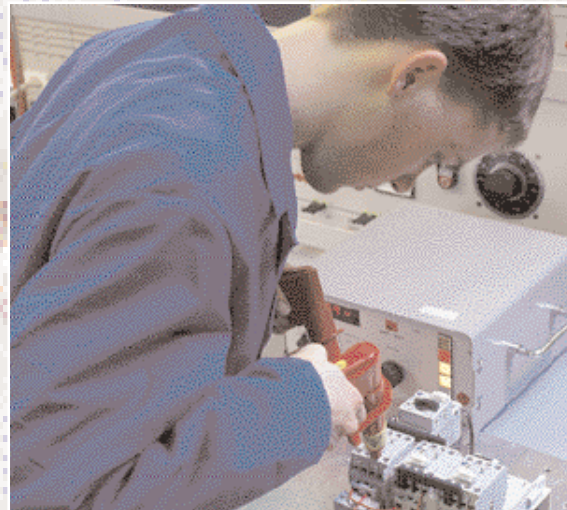

## Better terminals save wiring time

- Easy fitting of large cross sectional or combinations of conductors.
- Dual terminal technology offers more wiring flexibility.
- Insertion funnels and embedded terminals guarantee increased finger protection.

## Built for faster wiring

- Only one screwdriver (Pozidrive No. 2 or blade type No. 3) needed for all new 140M components.
- Screw driver guiding shafts speed up connection time.
- Delivered with open terminal screws for immediate wiring.

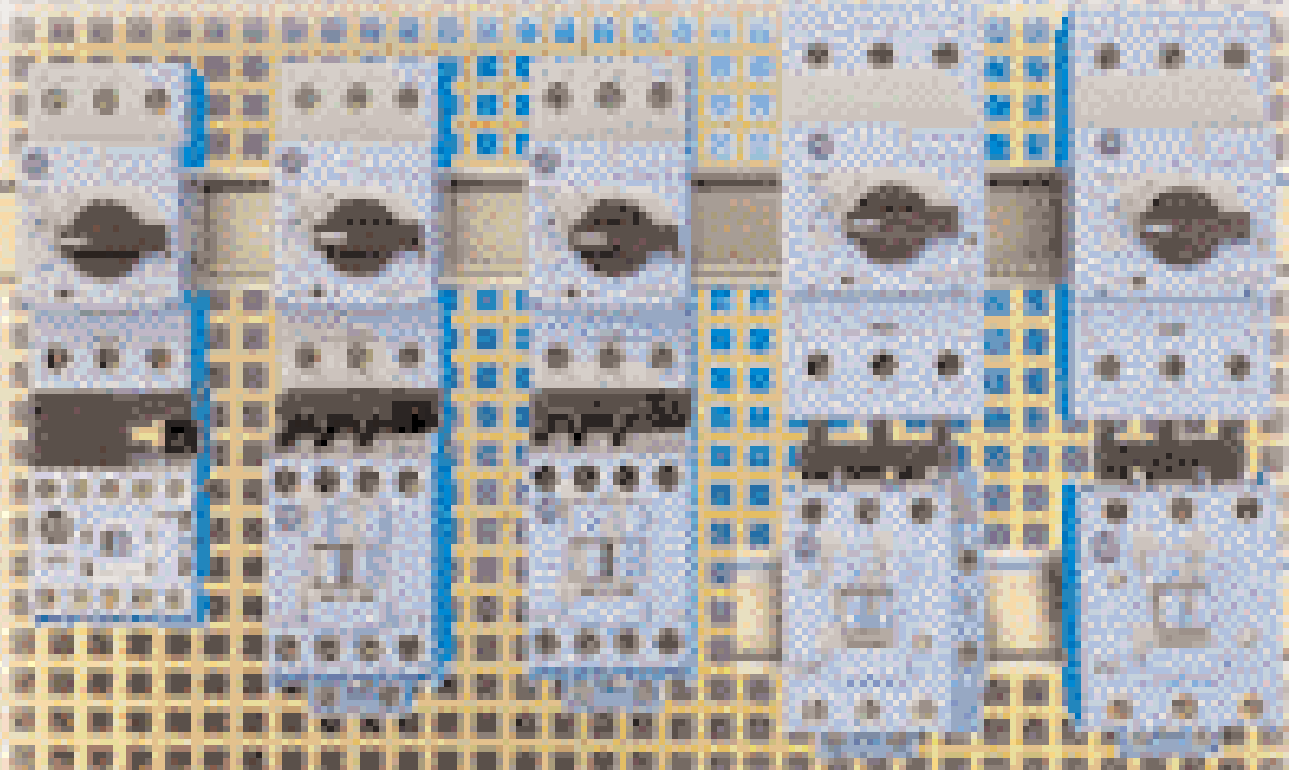

## The smart concept for fast panel building

- Complete range of compact busbars for easy wiring.
- Wiring sets facilitate the connection of circuit breakers and contactors.

- Wiring sets and busbars are inevitable for building assemblies in compliance with the new regulations (EN 60 439).
- With all the wiring accessories you can build assemblies fast, easy and safe.

# Any Other Circuit Breaker is a Waste of Space

Starter 22 kW 43 A

Space  
needed  
by others

Your gain  
in panel  
space

Achieves Type 2  
co-ordination with  
**NO OVERSIZING**  
of contactors

## The benefits of Type 2

- For today's assemblies in compliance with the regulations, Type 2 co-ordination is a necessity. Type 2 is synonymous for these benefits:
  - Reliable protection for people and plant
  - The starter is still fully operational after a short-circuit
  - The installation or the plant is back in operation quickly
  - Minimized downtime and minimized loss of production
  - Enhanced safety
  - Improved reliability.

## What is co-ordination Type 2?

- According to IEC 947-4-1, co-ordination Type 2 is achieved when these conditions are fulfilled:
  - The contactor or the starter must not endanger persons or systems in the event of a short circuit
  - The contactor or the starter must be suitable for further use
  - No damage to the overload relay or other parts may occur with the exception of welding of the contactor or starter contacts provided that these can be easily separated without significant deformation (such as with a screwdriver).

## Type 2 with no oversizing

- The new circuit-breakers 140M achieve Type 2 co-ordination automatically at 400V:
  - Determine the rated motor current
  - Select the type of 140M and 100-C-contactor accordingly.
- The fast opening contacts and the high current limiting qualities of the 140M make Type 2 co-ordination possible
  - without current limiters
  - with no oversizing of contactors.
- The result are slimmer, more compact starters with less wasted space and with a superior price/performance ratio.

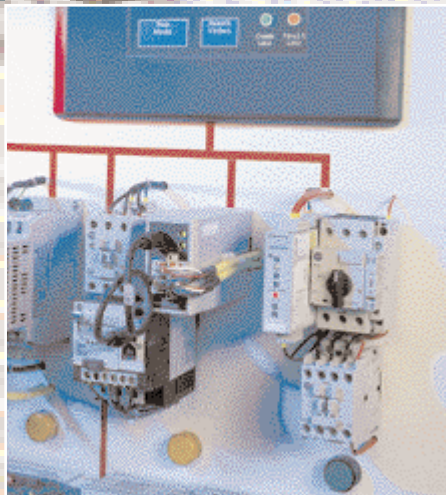
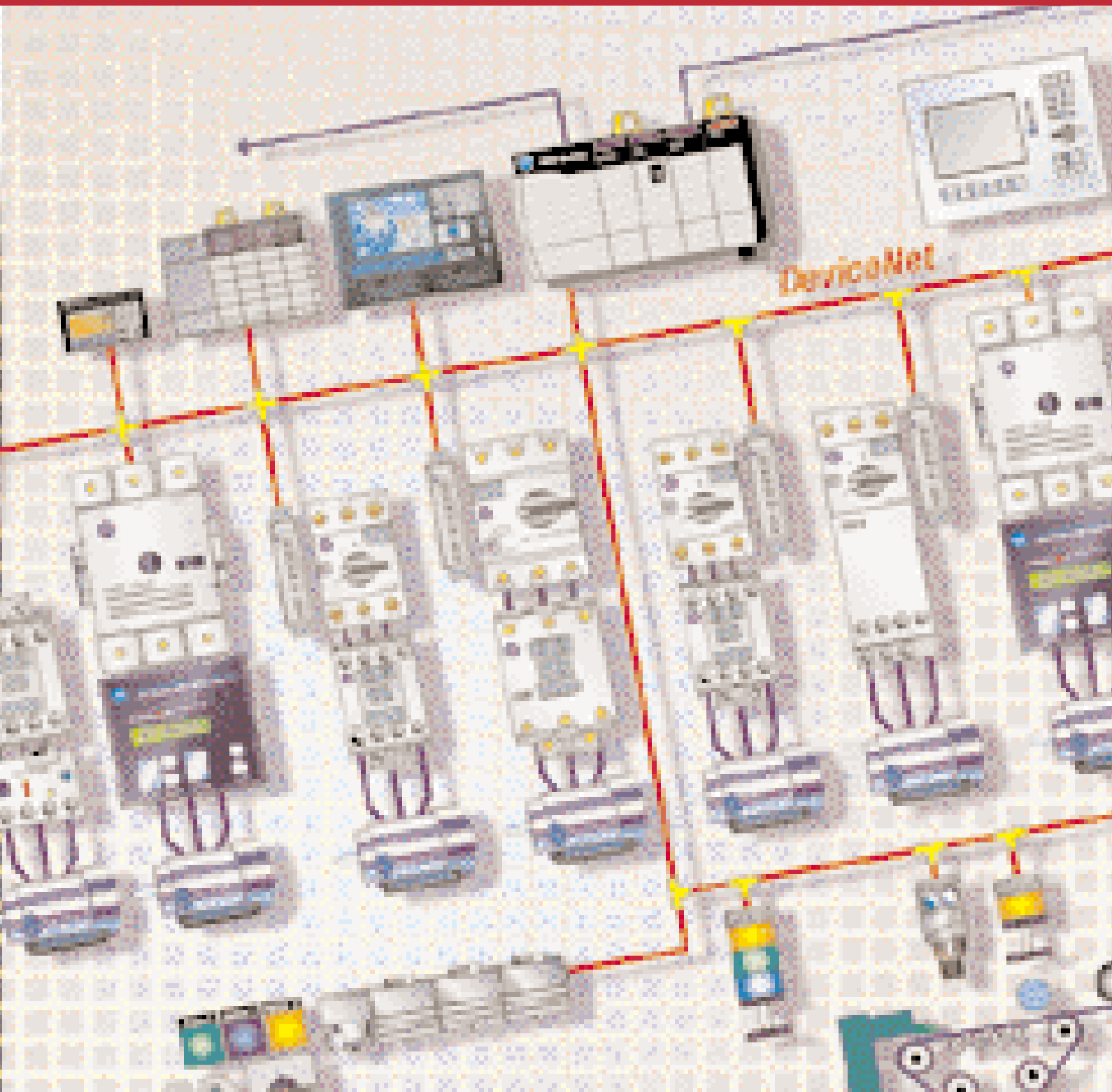

#### Motor Management for flexible solutions

- Motor Management is the way of Rockwell Automation to flexible solution for the industrial automation.
- The core of Motor Management is the MCS – Modular Control System – and the new circuit breakers 140M are a fundamental part of MCS and follow consistently the ideas of MCS:
  - All components are designed for electrical and dimensional co-ordination which makes assembly very easy
  - Consistent 9 mm spacing simplifies planning and installation.
- In combination with the DeviceNet Starter Auxiliary Module, 140M are easily integrated in modern networks.

# Your Best Choice.



## Developed for the world marketplace

- The new circuit breakers 140M are developed and manufactured in Europe for the tough requirements of the world market.
- The components fulfill the international standards IEC 947-1/2/4. This allows applications around the world.
- In North America, the devices can be used as Manual Motor Starter in Group Installations according UL 508. The approval for new UL 508 Type E Combination Starter is under preparation.

## A top product from a global leader

- Allen-Bradley is the premier brand of Rockwell Automation, a global leader; No. 1 in North America, and Top 3 world wide.
- Rockwell Automation is a global company committed to serving needs locally with 620 sales- and support offices in more than 80 countries.
- 5'600 distributors, system integrators and agents worldwide guarantee assistance and service around the globe.

## Winning the future with excellence

- The new circuit breakers 140M set benchmarks in performance but also in environmental excellence.
- The development and the production of the 140M is made under a the very stringent quality management system according ISO 9001. This maintains the performance of the 140M consistently on the very high specified level.
- The environmental management system according to ISO 14001 assures an ecological production and environment friendly materials.



## Circuit Breakers Bulletin 140M

- **Power Range**  
0.1...45 A
- **Various Protection Characteristics**
- **Easily Recognizable State of Operation**
- **High Current Limiting**
- **High Switching Capacity**

### Contents

Description	Page	Description	Page
<b>Product Selection</b>		<b>Technical Information</b>	
Motor protection . . . . .	14	Performance . . . . .	21
Short-circuit protection for starters . . . . .	15	General . . . . .	27
Transformer protection . . . . .	16	Standards and Approvals . . . . .	28
Compact starters . . . . .	17	Weight . . . . .	29
<b>Accessories . . . . .</b>	<b>18</b>	Accessories . . . . .	28
		Short-circuit coordination . . . . .	30
		<b>Dimensions . . . . .</b>	<b>32</b>

**Motor protection**

- Adjustable thermal release
- Magnetic release 13 x  $I_e$  max.
- Tripclass 10
- Ambient temperature compensation
- Phase-failure protection



140M-C2E



140M-D8E



140M-F8E

Rated operational current $I_e$ [A]	Thermal release Adjustment range [A]	Magnetic release Operating current [A]	Switching of 3 phase AC motors, AC-2, AC-3						$I_{cu}$	$I_{cs}$	Cat. No.
			3-phase [kW] (50 Hz)			3-phase [HP] (60 Hz) $\bullet$					
			230 V	400 V	690 V	230 V	460 V	575 V	[kA]	[kA]	
<b>140M-C2E Size 1, High break</b>											
0.16	0.1...0.16	2.1	-	0.02	-	-	-	-	100	100	140M-C2E-A16
0.25	0.16...0.25	3.3	-	0.06	-	-	-	-	100	100	140M-C2E-A25
0.4	0.25...0.4	5.2	-	0.09	-	-	-	-	100	100	140M-C2E-A40
0.63	0.4...0.63	8.2	0.06/0.09	0.12/0.18	0.25	-	-	-	100	100	140M-C2E-A63
1.0	0.63...1.0	13	0.12	0.25	0.37/0.55	-	-	1/2	100	100	140M-C2E-B10
1.6	1.0...1.6	21	0.18/0.25	0.37/0.55	0.75/1.1	-	3/4	3/4	100	100	140M-C2E-B16
2.5	1.6...2.5	33	0.37	0.75	1.8	1/2	1	1-1/2	100	100	140M-C2E-B25
4.0	2.5...4.0	52	0.55/0.75	1.1/1.5	2.2/3.0	3/4	2	3	100	100	140M-C2E-B40
6.3	4.0...6.3	82	1.1/1.5	2.2	4.0	1-1/2	3	5	100	100	140M-C2E-B63
10	6.3...10	130	2.2	3.0/4.0	5.5/7.5	3	5	7-1/2	100	100	140M-C2E-C10
16	10...16	208	3.0/4.0	5.5/7.5	11/13	-	10	10	50	50	140M-C2E-C16
20	14.5...20	260	4.0/5.5	7.5/10	15/17	5	-	15	15	15	140M-C2E-C20
25	18...25	325	-	11	18.5/22	7-1/2	15	20	15	15	140M-C2E-C25
<b>140M-D8E Size 2, High break PLUS</b>											
2.5	1.6...2.5	33	0.37	0.75	1.8	1/2	1	1-1/2	100	100	140M-D8E-B25
4.0	2.5...4.0	52	0.55/0.75	1.1/1.5	2.2/3.0	3/4	2	3	100	100	140M-D8E-B40
6.3	4.0...6.3	82	1.1/1.5	2.2	4.0	1-1/2	3	5	100	100	140M-D8E-B63
10	6.3...10	130	2.2	3.0/4.0	5.5/7.5	3	5	7-1/2	100	100	140M-D8E-C10
16	10...16	208	3.0/4.0	5.5/7.5	11/13	-	10	10	100	50	140M-D8E-C16
20	14.5...20	260	4.0/5.5	7.5/10	15/17	5	-	15	50	25	140M-D8E-C20
25	18...25	325	-	11	18.5/22	7-1/2	15	20	50	25	140M-D8E-C25
<b>140M-F8E Size 3, High break PLUS</b>											
10	6.3 ... 10	130	2.2	3.0/4.0	5.5/7.5	3	5	7-1/2	50	50	140M-F8E-C10
16	10 ... 16	208	3.0/4.0	5.5/7.5	11/13	-	10	10	50	50	140M-F8E-C16
20	14.5...20	260	4.0/5.5	7.5/10	15/17	5	-	15	50	25	140M-F8E-C20
25	18 ... 25	325	5.5/6.3	11	18.5/22	7-1/2	15	20	50	25	140M-F8E-C25
32	23 ... 32	416	7.5	15	22/25	10	20	25	50	25	140M-F8E-C32
45	32 ... 45	585	11/13	18.5/22	30/40	15	30	40	50	25	140M-F8E-C45

$\bullet$  UL- Approval only as manual motor controller, see page 24

### Short-circuit protection for starters

- without thermal release
- Magnetic release  $13 \times I_e$



140M-C2N



140M-D8N



140M-F8N

Rated operational current $I_e$ [A]	Thermal release Adjustment range [A]	Magnetic release Operating current [A]	Switching of 3 phase AC motors, AC-2, AC-3						$I_{cu}$ [kA]	$I_{cs}$ [kA]	Cat. No.
			3-phase [kW] (50 Hz)			3-phase [HP] (60 Hz) $\bullet$					
			230 V	400 V	690 V	230 V	460 V	575 V	[kA]	[kA]	
<b>140M-C2N Size 1, High break</b>											
0.16	-	2.1	-	0.02	-	-	-	-	100	100	140M-C2N-A16
0.25	-	3.3	-	0.06	-	-	-	-	100	100	140M-C2N-A25
0.4	-	5.2	-	0.09	-	-	-	-	100	100	140M-C2N-A40
0.63	-	8.2	0.06/0.09	0.12/0.18	0.25	-	-	-	100	100	140M-C2N-A63
1.0	-	13	0.12	0.25	0.37/0.55	-	-	1/2	100	100	140M-C2N-B10
1.6	-	20	0.18/0.25	0.37/0.55	0.75/1.1	-	3/4	3/4	100	100	140M-C2N-B16
2.5	-	32	0.37	0.75	1.8	1/2	1	1-1/2	100	100	140M-C2N-B25
<b>140M-D8N Size 2, High break PLUS</b>											
2.5	-	32	0.37	0.75	1.8	1/2	1	1-1/2	100	100	140M-D8N-B25
4	-	52	0.55/0.75	1.1/1.5	2.2/3.0	3/4	2	3	100	100	140M-D8N-B40
6.3	-	82	1.1/1.5	2.2	4.0	1-1/2	3	5	100	100	140M-D8N-B63
10	-	130	2.2	3.0/4.0	5.5/7.5	3	5	7-1/2	100	100	140M-D8N-C10
16	-	208	3.0/4.0	5.5/7.5	11/13	-	10	10	100	50	140M-D8N-C16
25	-	325	-	11	18.5/22	7-1/2	15	20	50	25	140M-D8N-C25
<b>140M-F8N Size 3, High break PLUS</b>											
25	-	325	5.5/6.3	11	18.5/22	7-1/2	15	20	50	25	140M-F8N-C25
32	-	416	7.5	15	22/25	10	20	25	50	25	140M-F8N-C32
45	-	585	11/13	18.5/22	30/40	15	30	40	50	25	140M-F8N-C45

$\bullet$  UL- Approval only as manual motor controller, see page 24

#### Utilization categories for alternating current per IEC 947:

AC-2 starting and reversing of slip ring motors  
AC-3 starting and disconnecting squirrel cage induction motors

#### IEC 947-2 performance categories:

$I_{cu}$  Ultimate short-circuit breaking capacity still operational after testing with O-t-CO

$I_{cs}$  Rated service short-circuit breaking capacity suitable for normal operation after testing with O-t-CO-t-CO

- O = off
- CO = restart and off
- t = time delay



**Transformer protection**

- Adjustable thermal release
- Magnetic release for higher trip currents
- Tripclass 10
- Ambient temperature compensation
- Phase-failure protection



140M-C2T



140M-D8T



140M-F8T

Rated operational current <i>I<sub>e</sub></i> [A]	Thermal release Adjustment range [A]	Magnetic release Operating current [A]	Switching of 3 phase AC motors, AC-2, AC-3						<i>I<sub>cu</sub></i> 400 V	<i>I<sub>cs</sub></i> 400 V	Cat. No.
			3-phase [kW] (50 Hz)			3-phase [HP] (60 Hz) ●					
			230 V	400 V	690 V	230 V	460 V	575 V	[kA]	[kA]	
<b>140M-C2T Size 1, High break</b>											
0.16	0.1...0.16	3.2	-	0.02	-	-	-	-	100	100	140M-C2T-A16
0.25	0.16...0.25	5.2	-	0.06	-	-	-	-	100	100	140M-C2T-A25
0.4	0.25...0.4	8.2	-	0.09	-	-	-	-	100	100	140M-C2T-A40
0.63	0.4...0.63	13	0.06/0.09	0.12/0.18	0.25	-	-	-	100	100	140M-C2T-A63
1.0	0.63...1.0	21	0.12	0.25	0.37/0.55	-	-	1/2	100	100	140M-C2T-B10
1.6	1.0...1.6	32	0.18/0.25	0.37/0.55	0.75/1.1	-	3/4	3/4	100	100	140M-C2T-B16
2.5	1.6...2.5	52	0.37	0.75	1.8	1/2	1	1-1/2	100	100	140M-C2T-B25
4.0	2.5...4.0	82	0.55/0.75	1.1/1.5	2.2/3.0	3/4	2	3	100	100	140M-C2T-B40
6.3	4.0...6.3	130	1.1/1.5	2.2	4.0	1-1/2	3	5	100	100	140M-C2T-B63
10	6.3...10	208	2.2	3.0/4.0	5.5/7.5	3	5	7-1/2	100	100	140M-C2T-C10
16	10...16	260	3.0/4.0	5.5/7.5	11/13	-	10	10	15	15	140M-C2T-C16
<b>140M-D8T Size 2, High break PLUS</b>											
16	10...16	260	3.0/4.0	5.5/7.5	11/13	-	10	10	50	25	140M-D8T-C16
20	14.5...20	325	4.0/5.5	7.5/10	15/17	5	-	15	50	25	140M-D8T-C20
<b>140M-F8T Size 3, High break PLUS</b>											
25	18...25	416	5.5/6.3	11	18.5/22	7-1/2	15	20	50	25	140M-F8T-C25
32	23...32	585	7.5	15	22/25	10	20	25	50	25	140M-F8T-C32

● UL- Approval only as manual motor controller, see page 24

**Utilization categories for alternating current per IEC 947:**

AC-2 starting and reversing of slip ring motors  
 AC-3 starting and disconnecting squirrel cage induction motors

**IEC 947-2 performance categories:**

*I<sub>cu</sub>* Ultimate short-circuit breaking capacity still operational after testing with O-t-CO  
*I<sub>cs</sub>* Rated service short-circuit breaking capacity suitable for normal operation after testing with O-t-CO-t-CO

O = off  
 CO = restart and off  
 t = time delay



- Auxiliary contact connections on terminal blocks below wired
- Application of accessories circuit breaker 140M-C and contactor 100-C

Mounting-possibilities: - Screw fixing  
- Snap fixing on 1 or 2 DIN rails 35 mm  
- Snap fixing on DIN rail 75 mm



### Coordination Type “2” according to IEC 947-4-1

Short-circuit current  $I_q = I_{cu}$

Voltage: 400/415 V 50 Hz,

Starters for motor-voltage up to 690 V on request

Standard motors AC-3, 3 phase 400/415 V	Thermal trip	Magnetic trip	$I_{cu}$	Direct starter	
					Cat. No.
[kW]	[A]	[A]	[kA]		
0.04	0.10...0.16	2.1	100		190S-AN ⊗ 2 -CA16 C
0.06	0.16...0.25	3.3	100		190S-AN ⊗ 2 -CA25 C
0.09	0.25...0.40	5.2	100		190S-AN ⊗ 2 -CA40 C
0.12	0.40...0.63	8.2	100		190S-AN ⊗ 2 -CA63 C
0.18...0.25	0.63...1.00	13	100		190S-AN ⊗ 2 -CB10 C
0.37...0.55	1.00...1.60	21	100		190S-AN ⊗ 2 -CB16 C
0.75	1.60...2.50	33	100		190S-AN ⊗ 2 -CB25 C
1.1...1.5	2.50...4.00	52	100		190S-AN ⊗ 2 -CB40 C
2.2	4.00...6.30	82	100		190S-AN ⊗ 2 -CB63 C
3.0...4.0	6.30...10.0	130	100		190S-AN ⊗ 2 -CC10 C
5.5	10.0...16.0	208	50		190S-BN ⊗ 2 -CC16 C
5.5...7.5	10.0...16.0	208	50		190S-CN ⊗ 2 -CC16 C
7.5...10	14.5...20.0	260	50		190S-DN ⊗ 2 -DC20 C
11	18.5...25.0	325	50		190S-DN ⊗ 2 -DC25 C

①

②

### ① Auxiliary contacts for contactor

Option	Number of NO / NC contacts for contactor
1	1 N.C.
2	1 N.O.

### ② Auxiliary contacts for circuit breaker (Front mounting)

Option	Number of NO / NC contacts for circuit breaker
A	1 N.C.
B	1 N.O.
C	1 N.O. + 1 N.C.
D	2 N.O.
R	1 N.C. + 1 N.O. Trip
S	1 N.O. + 1 N.O. Trip







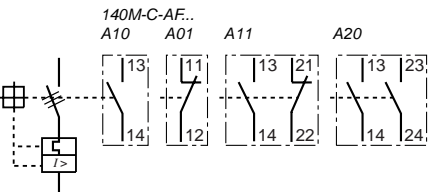

### ⊗ Standard voltages for AC control

	[V]	12	24	32	36	42	48	100	100-110	110	120	127	200	200-220	200-230	208	208-240	
	190S	50 Hz	(R)	(K)	(V)	(W)	(X)	(Y)	(KP)	-	(D)	(P)	(S)	(KG)	-	-	-	-
60 Hz		(Q)	(J)	-	(V)	-	(X)	-	(KP)	-	(D)	-	-	(KG)	-	(H)	(L)	
50/60 Hz		-	KJ	-	-	-	KY	(KP)	-	KD	-	-	(KG)	-	(KL)	-	-	
[V]		220-230	230	230-240	240	277	347	380	380-400	400	400-415	440	480	500	550	600		
50 Hz		(F)	-	(VA)	(T)	-	-	-	(N)	-	(G)	(B)	-	(M)	(C)	-		
60 Hz		-	-	-	(A)	(T)	(I)	(E)	-	-	-	(N)	(B)	-	-	(C)		
50/60 Hz		-	KF	-	(KA)	-	-	-	-	KN	-	(KB)	-	-	-	-		

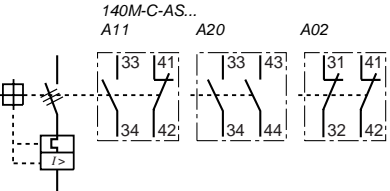

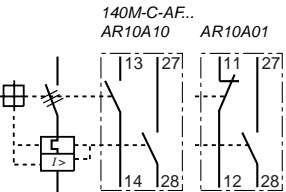

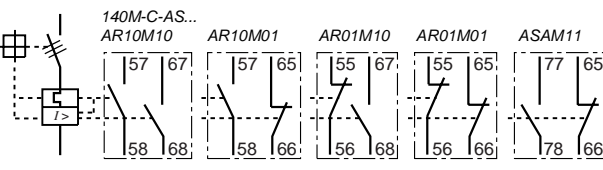

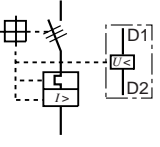
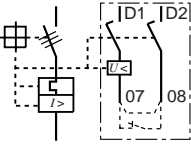
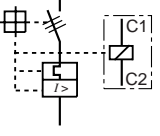

Additional price for:	Type	Possible control voltages	No additional price
Special control voltages	100-C	12...600 V 50 Hz / 12...600 V 60 Hz	greater than 20 pcs.

( ) Control voltages in parentheses: Not on stock (longer delivery time)



**Accessories**

	Description		Connection diagram	Cat. No.
	<p><b>Auxiliary contact</b></p> <ul style="list-style-type: none"> <li>• Front mounting</li> <li>• 1- or 2-pole</li> <li>• One front mounting module per circuit breaker</li> </ul>		 <p>140M-C-AF... A10 A01 A11 A20</p>	<p>140M-C-AFA10 140M-C-AFA01 140M-C-AFA11 140M-C-AFA20</p>
	<p><b>Auxiliary contact</b></p> <ul style="list-style-type: none"> <li>• Side mounting on the right</li> <li>• 2-pole</li> <li>• One side mounting module per circuit breaker. (Combined with a trip contact, always fitted on the side of the trip contact).</li> </ul>		 <p>140M-C-AS... A11 A20 A02</p>	<p>140M-C-ASA20 140M-C-ASA02 140M-C-ASA11</p>
	<p><b>Combination Trip/Auxiliary contact</b></p> <ul style="list-style-type: none"> <li>• Front mounting</li> <li>• 2-pole</li> <li>• One front mounting module per circuit breaker</li> </ul>		 <p>140M-C-AF... AR10A10 AR10A01</p>	<p>140M-C-AFAR10A10 140M-C-AFAR10A01</p>
	<p><b>Trip contact</b></p> <ul style="list-style-type: none"> <li>• Side mounting on the right</li> <li>• 2-pole</li> <li>• One side mounting module per circuit breaker. (Always directly fitted to the circuit breaker).</li> </ul>		 <p>140M-C-AS... AR10M10 AR10M01 AR01M10 AR01M01 ASAM11</p>	<p>140M-C-ASAR10M10 140M-C-ASAR10M01 140M-C-ASAR01M10 140M-C-ASAR01M01 140M-C-ASAM11</p>
	<p><b>Undervoltage release</b></p> <ul style="list-style-type: none"> <li>• Side mounting on the left</li> <li>• One left side mounted module per circuit breaker</li> </ul>		<p>21 V, 50 Hz / 24 V, 60 Hz 24 V, 50 Hz / 28 V, 60 Hz 105 V, 50 Hz / 120 V, 60 Hz 110 V, 50 Hz / 127 V, 60 Hz 220...230 V, 50 Hz 240...260 V, 60 Hz 240 V, 50 Hz / 277 V, 60 Hz 380...400 V, 50 Hz / 440...460 V, 60 Hz 415 V, 50 Hz / 480 V, 60 Hz</p>	<p>140M-C-UXJ 140M-C-UXK 140M-C-UXD 140M-C-UXC 140M-C-UXF 140M-C-UXA 140M-C-UXT 140M-C-UXN 140M-C-UXB</p>
<p><b>Undervoltage release</b></p> <ul style="list-style-type: none"> <li>• Side mounting on the left</li> <li>• 2 early make contacts integrated</li> <li>• One left side mounted module per circuit breaker</li> </ul>		<p>21 V, 50 Hz / 24 V, 60 Hz 24 V, 50 Hz / 28 V, 60 Hz 105 V, 50 Hz / 120 V, 60 Hz 110 V, 50 Hz / 127 V, 60 Hz 220...230 V, 50 Hz 240...260 V, 60 Hz 240 V, 50 Hz / 277 V, 60 Hz 380...400 V, 50 Hz / 440...460 V, 60 Hz 415 V, 50 Hz / 480 V, 60 Hz</p>	<p>140M-C-UCJ 140M-C-UCK 140M-C-UCD 140M-C-UCC 140M-C-UCF 140M-C-UCA 140M-C-UCT 140M-C-UCN 140M-C-UCB</p>	
<p><b>Shunt release</b></p> <ul style="list-style-type: none"> <li>• Side mounting on the left</li> <li>• One left side mounted module per circuit breaker</li> </ul>		<p>21 V, 50 Hz / 24 V, 60 Hz 24 V, 50 Hz / 28 V, 60 Hz 105 V, 50 Hz / 120 V, 60 Hz 110 V, 50 Hz / 127 V, 60 Hz 220...230 V, 50 Hz 240...260 V, 60 Hz 240 V, 50 Hz / 277 V, 60 Hz 380...400 V, 50 Hz / 440...460 V, 60 Hz 415 V, 50 Hz / 480 V, 60 Hz</p>	<p>140M-C-SNJ 140M-C-SNK 140M-C-SND 140M-C-SNC 140M-C-SNF 140M-C-SNA 140M-C-SNT 140M-C-SNN 140M-C-SNB</p>	

**Accessories**

	Description	to use with	Cat. No.	
	<b>Anti-Tamper shield</b> <ul style="list-style-type: none"> <li>Provides protection against inadvertent adjustment of the current setting</li> </ul>	140M-C 140M-D 140M-F	140M-C-CA	
	<b>Lockable rotary handle</b> <ul style="list-style-type: none"> <li>1 padlock ø 3...6 mm</li> <li>locking in "0" position</li> </ul>	black	140M-C 140M-D 140M-F 140M-C-KN	
		red / yellow	140M-C 140M-D	140M-C-KRY
			140M-F	140M-F-KRY
	<b>Locking arrangement</b> <ul style="list-style-type: none"> <li>Increases the padlockable facility of the lockable rotary handle</li> <li>1...3 padlocks ø 4...8 mm</li> </ul>	140M-C-KN 140M-C-KRY 140M-F-KRY	140M-C-M3	
	<b>Door coupling handle</b> <ul style="list-style-type: none"> <li>Lockable with 1...3 padlocks ø 4...8 mm</li> <li>Protection IP 66</li> <li>Interlock override facility</li> <li>Can be modified for locking in "1" position</li> <li>Scope of delivery: Door handle and coupling</li> </ul> Mounting-depth (Adapter - Door) 140-C 105.5 mm ± 5 mm 140-D 114.5 mm ± 5 mm 140-F 137.1 mm ± 5 mm (Please order extension shaft and legend plate separately)	black	140M-C 140M-D 140M-F 140M-C-DN66	
		red / yellow	140M-C 140M-D 140M-F 140M-C-DRY66	
	<b>Extension shaft</b> <ul style="list-style-type: none"> <li>Cut to required length for</li> </ul> Mounting-depth (Adapter - Door) 140-C 117...338 mm 140-D 126...347 mm 140-F 149...369 mm	140M-C-DN66 140M-C-DRY66	140M-C-DS	
	<b>Legend plate</b> <ul style="list-style-type: none"> <li>Marking: "Hauptschalter" and "Main Switch"</li> <li>Marking: "Not-Aus" and "Emergency - Off"</li> </ul>	black / grey	140M-C-DN66 140M-C-DFCN	
		black / yellow	140M-C-DRY66 140M-C-DFCRY	
	<b>Screw adapter clip</b> <ul style="list-style-type: none"> <li>For screw mounting of a circuit breaker</li> </ul>	140M-C 140M-D 140M-F	140M-C-N45	

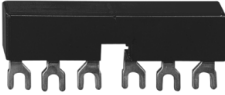
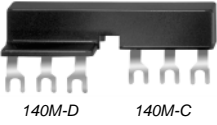
**Accessories**

	Description	to use with	Cat. No.	
	<b>Busbar feeder terminal</b> <ul style="list-style-type: none"> <li>Supply of compact busbars</li> <li>Increases terminal capacity (max. 25 mm<sup>2</sup>)</li> </ul>	140M-C 140M-D	140M-C-WT	
		140M-F	140M-F-WT	
	<b>Compact busbars</b> (for circuit breakers 25 A) <ul style="list-style-type: none"> <li>45 mm spacing</li> <li>With front-mounted auxiliary contact</li> </ul>	2 x 3 connections	140M-C	140M-C-W452
		3 x 3 connections	140M-C	140M-C-W453
		4 x 3 connections	140M-D	140M-C-W454
		5 x 3 connections	140M-D	140M-C-W455
	<ul style="list-style-type: none"> <li>54 mm spacing</li> <li>With side-mounted trip contact or auxiliary contact</li> </ul>	2 x 3 connections	140M-C	140M-C-W542
		3 x 3 connections	140M-C	140M-C-W543
		4 x 3 connections	140M-D	140M-C-W544
		5 x 3 connections	140M-D	140M-C-W545
	<ul style="list-style-type: none"> <li>63 mm spacing</li> <li>With side-mounted trip contact and auxiliary contact</li> </ul>	2 x 3 connections	140M-C	140M-C-W632
		3 x 3 connections	140M-C	140M-C-W633
		4 x 3 connections	140M-D	140M-C-W634
		5 x 3 connections	140M-D	140M-C-W635
 140M-D      140M-C	<b>Compact busbar</b> <ul style="list-style-type: none"> <li>Connects 140M-D with 140M-C</li> <li>Can be used in combination with all other busbars</li> <li>54 mm spacing</li> </ul>	2 x 3 connections	140M-D to 140M-C	140M-C-WD542
	<b>Blank space cover</b> <ul style="list-style-type: none"> <li>For covering of unused connection lugs</li> </ul>	140M-C 140M-D	140M-C-WS	
	<b>Connecting modules ECO-starters</b> <ul style="list-style-type: none"> <li>The ECO-connecting modules provide electrical and mechanical interconnection, safely, quickly and simply.</li> <li>Suitable for reversing and star/delta kits</li> <li>ECO-starters mount on single DIN-rail</li> <li>Additional mechanical support of 100-C contactors recommended</li> </ul>	140M-C to 100-M	140M-C-PEM12	
		140M-C to 100-C09...C23	140M-C-PEC23	
		140M-D to 100-C09...C23	140M-D-PEC23	
	<b>Connecting modules</b> <ul style="list-style-type: none"> <li>Electrical interconnection between circuit breaker 140M-F and contactors 100-C</li> <li>Additional mechanical support of contactors and circuit breaker required</li> </ul>			
		140M-F to 100-C30...C37	140M-F-PNC37	
		140M-F to 100-C43	140M-F-PNC43	

IEC Performance Data (Motor protection 140M-..E)

$I_e$	140M-C2E												
	-A16 0.16A	-A25 0.25A	-A40 0.4A	-A63 0.63A	-B10 1A	-B16 1.6A	-B25 2.5A	-B40 4A	-B63 6.3A	-C10 10A	-C16 16A	-C20 20A	-C25 25A
<b>Switching of standard three-phase motors</b> AC-2, AC-3													
230/240 V [kW]	-	-	-	0.06/0.09	0.12	0.18/0.25	0.37	0.55/0.75	1.1/1.5	2.2	3.0/4.0	4.0/5.5	-
400/415 V [kW]	0.02	0.06	0.09	0.12/0.18	0.25	0.37/0.55	0.75	1.1/1.5	2.2	3.0/4.0	5.5/7.5	7.5/10	11
500 V [kW]	-	-	-	0.18	0.25/0.37	0.55/0.75	1.1	1.5/2.2	2.5/3.0	4.0/6.3	7.5/10	11	15
690 V [kW]	-	-	-	0.25	0.37/0.55	0.75/1.1	1.8	2.2/3.0	4.0	5.5/7.5	11/13	15/17	18.5/22
<b>Back-up fuses</b> gG, gL, only if $I_{cc} > I_{cu}$ (◆ = no Back-up fuse required)													
230/240 V [A]	◆	◆	◆	◆	◆	◆	◆	◆	◆	◆	◆	100	100
400/415 V [A]	◆	◆	◆	◆	◆	◆	◆	◆	◆	◆	80	100	100
440/460 V [A]	◆	◆	◆	◆	◆	◆	◆	◆	◆	63	63	80	80
500 V [A]	◆	◆	◆	◆	◆	◆	◆	◆	◆	80	80	80	80
690 V [A]	◆	◆	◆	◆	◆	16	20	35	50	50	63	63	63
<b>Ultimate short-circuit breaking capacity <math>I_{cu}</math></b>													
230/240 V [kA]	100	100	100	100	100	100	100	100	100	100	100	50	50
400/415 V [kA]	100	100	100	100	100	100	100	100	100	100	50	15	15
440/460 V [kA]	100	100	100	100	100	100	100	100	100	50	10	10	10
500 V [kA]	100	100	100	100	100	100	100	100	100	50	10	6	6
690 V [kA]	100	100	100	100	100	8	8	8	4	4	3	3	3
<b>Rated service short-circuit breaking capacity <math>I_{cs}</math></b>													
230/240 V [kA]	100	100	100	100	100	100	100	100	100	100	100	50	50
400/415 V [kA]	100	100	100	100	100	100	100	100	100	100	50	15	15
440/460 V [kA]	100	100	100	100	100	100	100	100	100	50	6	6	6
500 V [kA]	100	100	100	100	100	100	100	100	100	50	6	6	6
690 V [kA]	100	100	100	100	100	8	8	8	4	4	3	3	3

$I_e$	140M-D8E							140M-F8E						
	-B25 2.5A	-B40 4A	-B63 6.3A	-C10 10A	-C16 16A	-C20 20A	-C25 25A	-C10 10A	-C16 16A	-C20 20A	-C25 25A	-C32 32A	-C45 45A	
<b>Switching of standard three-phase motors</b> AC-2, AC-3														
230/240 V [kW]	0.37	0.55/0.75	1.1/1.5	2.2	3.0/4.0	4.0/5.5	-	2.2	3.0/4.0	4.0/5.5	5.5/6.3	7.5	11/13	
400/415 V [kW]	0.75	1.1/1.5	2.2	3.0/4.0	5.5/7.5	7.5/10	11	3.0/4.0	5.5/7.5	7.5/10	11	15	18.5/22	
500 V [kW]	1.1	1.5/2.2	2.5/3.0	4.0/6.3	7.5/10	11	15	4.0/6.3	7.5/10	11	15	15/20	22/30	
690 V [kW]	1.8	2.2/3.0	4.0	5.5/7.5	11/13	15/17	18.5/22	5.5/7.5	11/13	15/17	18.5/22	22/25	30/40	
<b>Back-up fuses</b> gG, gL, only if $I_{cc} > I_{cu}$ (◆ = no Back-up fuse required)														
230/240 V [A]	◆	◆	◆	◆	◆	◆	◆	◆	◆	◆	◆	◆	◆	
400/415 V [A]	◆	◆	◆	◆	◆	100	100	80	100	100	100	125	125	
440/460 V [A]	◆	◆	◆	◆	80	100	100	●	●	●	●	●	●	
500 V [A]	◆	◆	◆	◆	80	80	80	80	80	80	80	100	100	
690 V [A]	20	35	50	50	63	63	63	50	63	63	63	80	80	
<b>Ultimate short-circuit breaking capacity <math>I_{cu}</math></b>														
230/240 V [kA]	100	100	100	100	100	100	100	100	100	100	100	100	100	
400/415 V [kA]	100	100	100	100	100	50	50	50	50	50	50	50	50	
440/460 V [kA]	100	100	100	100	50	50	50	●	●	●	●	●	●	
500 V [kA]	100	100	100	40	25	25	25	10	10	10	10	10	10	
690 V [kA]	10	10	10	10	6	6	6	6	6	6	6	6	6	
<b>Rated service short-circuit breaking capacity <math>I_{cs}</math></b>														
230/240 V [kA]	100	100	100	100	100	100	100	100	100	100	100	100	100	
400/415 V [kA]	100	100	100	100	50	25	25	50	50	25	25	25	25	
440/460 V [kA]	100	100	100	100	50	25	25	●	●	●	●	●	●	
500 V [kA]	100	100	100	100	50	25	25	10	10	10	10	10	10	
690 V [kA]	10	10	10	6	4	4	4	6	6	6	6	6	4	

● Under preparation, please contact your local sales office

**IEC Performance Data (Short-circuit protection for starters 140M-..N)**

$I_e$	140M-C2N						
	-A16 0.16A	-A25 0.25A	-A40 0.4A	-A63 0.63A	-B10 1A	-B16 1.6A	-B25 2.5A
<b>Switching of standard three-phase motors</b> AC-2, AC-3							
230/240 V [kW]	-	-	-	0.06/0.09	0.12	0.18/0.25	0.37
400/415 V [kW]	0.02	0.06	0.09	0.12/0.18	0.25	0.37/0.55	0.75
500 V [kW]	-	-	-	0.18	0.25/0.37	0.55/0.75	1.1
690 V [kW]	-	-	-	0.25	0.37/0.55	0.75/1.1	1.8
<b>Back-up fuses</b> gG, gL, only if $I_{cc} > I_{cu}$ (◆ = no Back-up fuse required)							
230/240 V [A]	◆	◆	◆	◆	◆	◆	◆
400/415 V [A]	◆	◆	◆	◆	◆	◆	◆
440/460 V [A]	◆	◆	◆	◆	◆	◆	◆
500 V [A]	◆	◆	◆	◆	◆	◆	◆
690 V [A]	◆	◆	◆	◆	◆	16	20
<b>Ultimate short-circuit breaking capacity <math>I_{cu}</math></b>							
230/240 V [kA]	100	100	100	100	100	100	100
400/415 V [kA]	100	100	100	100	100	100	100
440/460 V [kA]	100	100	100	100	100	100	100
500 V [kA]	100	100	100	100	100	100	100
690 V [kA]	100	100	100	100	100	8	8
<b>Rated service short-circuit breaking capacity <math>I_{cs}</math></b>							
230/240 V [kA]	100	100	100	100	100	100	100
400/415 V [kA]	100	100	100	100	100	100	100
440/460 V [kA]	100	100	100	100	100	100	100
500 V [kA]	100	100	100	100	100	100	100
690 V [kA]	100	100	100	100	100	8	8

$I_e$	140M-D8N					140M-F8N			
	-B25 2.5A	-B40 4A	-B63 6.3A	-C10 10A	-C16 16A	-C25 25A	-C25 25A	-C32 32A	-C45 45A
<b>Switching of standard three-phase motors</b> AC-2, AC-3									
230/240 V [kW]	0.37	0.55/0.75	1.1/1.5	2.2	3.0/4.0	-	5.5/6.3	7.5	11/13
400/415 V [kW]	0.75	1.1/1.5	2.2	3.0/4.0	5.5/7.5	11	11	15	18.5/22
500 V [kW]	1.1	1.5/2.2	2.5/3.0	4.0/6.3	7.5/10	15	15	15/20	22/30
690 V [kW]	1.8	2.2/3.0	4.0	5.5/7.5	11/13	18.5/22	18.5/22	22/25	30/40
<b>Back-up fuses</b> gG, gL, only if $I_{cc} > I_{cu}$ (◆ = no Back-up fuse required)									
230/240 V [A]	◆	◆	◆	◆	◆	◆	◆	◆	◆
400/415 V [A]	◆	◆	◆	◆	◆	100	100	125	125
440/460 V [A]	◆	◆	◆	◆	80	100	●	●	●
500 V [A]	◆	◆	◆	◆	80	80	80	100	100
690 V [A]	20	35	50	50	63	63	63	80	80
<b>Ultimate short-circuit breaking capacity <math>I_{cu}</math></b>									
230/240 V [kA]	100	100	100	100	100	100	100	100	100
400/415 V [kA]	100	100	100	100	100	50	50	50	50
440/460 V [kA]	100	100	100	100	50	50	●	●	●
500 V [kA]	100	100	100	100	50	25	10	10	10
690 V [kA]	10	10	10	6	6	6	6	6	6
<b>Rated service short-circuit breaking capacity <math>I_{cs}</math></b>									
230/240 V [kA]	100	100	100	100	100	100	100	100	100
400/415 V [kA]	100	100	100	100	100	25	25	25	25
440/460 V [kA]	100	100	100	100	50	25	●	●	●
500 V [kA]	100	100	100	100	50	25	10	10	10
690 V [kA]	10	10	10	6	4	4	6	6	4

● Under preparation, please contact your local sales office



IEC Performance Data (Transformer protection 140M-..T)

	$I_e$	140M-C2T										
		-A16 0.16A	-A25 0.25A	-A40 0.4A	-A63 0.63A	-B10 1A	-B16 1.6A	-B25 2.5A	-B40 4A	-B63 6.3A	-C10 10A	-C16 16A
<b>Switching of standard three-phase motors</b> AC-2, AC-3												
230/240 V	[kW]	-	-	-	0.06/0.09	0.12	0.18/0.25	0.37	0.55/0.75	1.1/1.5	2.2	3.0/4.0
400/415 V	[kW]	0.02	0.06	0.09	0.12/0.18	0.25	0.37/0.55	0.75	1.1/1.5	2.2	3.0/4.0	5.5/7.5
500 V	[kW]	-	-	-	0.18	0.25/0.37	0.55/0.75	1.1	1.5/2.2	2.5/3.0	4.0/6.3	7.5/10
690 V	[kW]	-	-	-	0.25	0.37/0.55	0.75/1.1	1.8	2.2/3.0	4.0	5.5/7.5	11/13
<b>Back-up fuses</b> gG, gL, only if $I_{cc} > I_{cu}$ (◆ = no Back-up fuse required)												
230/240 V	[A]	◆	◆	◆	◆	◆	◆	◆	◆	◆	◆	◆
400/415 V	[A]	◆	◆	◆	◆	◆	◆	◆	◆	◆	◆	80
440/460 V	[A]	◆	◆	◆	◆	◆	◆	◆	◆	◆	63	63
500 V	[A]	◆	◆	◆	◆	◆	◆	◆	◆	◆	80	80
690 V	[A]	◆	◆	◆	◆	◆	16	20	35	50	50	63
<b>Ultimate short-circuit breaking capacity <math>I_{cu}</math></b>												
230/240 V	[kA]	100	100	100	100	100	100	100	100	100	100	100
400/415 V	[kA]	100	100	100	100	100	100	100	100	100	100	15
440/460 V	[kA]	100	100	100	100	100	100	100	100	100	50	10
500 V	[kA]	100	100	100	100	100	100	100	100	100	50	6
690 V	[kA]	100	100	100	100	100	8	8	8	4	4	3
<b>Rated service short-circuit breaking capacity <math>I_{cs}</math></b>												
230/240 V	[kA]	100	100	100	100	100	100	100	100	100	100	100
400/415 V	[kA]	100	100	100	100	100	100	100	100	100	100	15
440/460 V	[kA]	100	100	100	100	100	100	100	100	100	50	6
500 V	[kA]	100	100	100	100	100	100	100	100	100	50	6
690 V	[kA]	100	100	100	100	100	8	8	8	4	4	3

	$I_e$	140M-D8T		140M-F8T	
		-C16 16A	-C20 20A	-C25 25A	-C32 32A
<b>Switching of standard three-phase motors</b> AC-2, AC-3					
230/240 V	[kW]	3.0/4.0	4.0/5.5	5.5/6.3	7.5
400/415 V	[kW]	5.5/7.5	7.5/10	11	15
500 V	[kW]	7.5/10	11	15	15/20
690 V	[kW]	11/13	15/17	18.5/22	22/25
<b>Back-up fuses</b> gG, gL, only if $I_{cc} > I_{cu}$ (◆ = no Back-up fuse required)					
230/240 V	[A]	◆	◆	◆	◆
400/415 V	[A]	80	100	100	125
440/460 V	[A]	80	100	●	●
500 V	[A]	80	80	80	100
690 V	[A]	63	63	63	80
<b>Ultimate short-circuit breaking capacity <math>I_{cu}</math></b>					
230/240 V	[kA]	100	100	100	100
400/415 V	[kA]	50	50	50	50
440/460 V	[kA]	50	50	●	●
500 V	[kA]	25	25	10	10
690 V	[kA]	6	6	6	6
<b>Rated service short-circuit breaking capacity <math>I_{cs}</math></b>					
230/240 V	[kA]	100	100	100	100
400/415 V	[kA]	25	25	25	25
440/460 V	[kA]	25	25	●	●
500 V	[kA]	25	25	10	10
690 V	[kA]	4	4	6	6

● Under preparation, please contact your local sales office

**Bulletin 140M**  
**Manual Motor Controller**  
**Technical Information**

**UL / CSA Performance Data (Motor protection 140M-..E)**

**Manual Motor Controller**  
**(UL 508, CSA C22.2 No..14, for group installation, in connection with a short-circuit protection device)**

		140M-C2E												
		-A16 0.16A	-A25 0.25A	-A40 0.4A	-A63 0.63A	-B10 1A	-B16 1.6A	-B25 2.5A	-B40 4A	-B63 6.3A	-C10 10A	-C16 16A	-C20 20A	-C25 25A
<b>Max. short-circuit current</b>	480 V [kA]	65	65	65	65	65	65	65	65	65	65	10	10	10
	600 V [kA]	47	47	47	47	47	47	5	5	5	5	5	5	5
<b>Motor load</b>														
1 phase	115 V [HP]	-	-	-	-	-	-	-	1/8	1/4	1/2	3/4	1	1-1/2
	230 V [HP]	-	-	-	-	-	-	1/10	1/6	1/3	1/2	1	2	3
3 phase	230 V [HP]	-	-	-	-	-	-	1/2	3/4	1-1/2	3	5	5	7-1/2
	460 V [HP]	-	-	-	-	-	-	3/4	1	2	3	5	10	-
	575 V [HP]	-	-	-	-	1/2	3/4	1-1/2	3	5	7-1/2	10	15	20
<b>Maximum rated current of protection device</b> [A]		400												

		140M-D8E							140M-F8E						
		-B25 2.5A	-B40 4A	-B63 6.3A	-C10 10A	-C16 16A	-C20 20A	-C25 25A	-C10 10A	-C16 16A	-C20 20A	-C25 25A	-C32 32A	-C45 45A	
<b>Max. short-circuit current</b>	480 V [kA]	65	65	65	65	65	65	25	●	●	●	●	●	●	
	600 V [kA]	10	10	10	10	10	5	5	●	●	●	●	●	●	
<b>Motor load</b>															
1 phase	115 V [HP]	-	1/8	1/4	1/2	3/4	1	1-1/2	1/2	3/4	1	1-1/2	2	3	
	230 V [HP]	1/6	1/3	1/2	1	2	3	-	1	2	3	-	5	7-1/2	
3 phase	230 V [HP]	1/2	3/4	1-1/2	3	-	5	7-1/2	3	-	5	7-1/2	10	15	
	460 V [HP]	1	2	3	5	10	-	15	5	10	-	15	20	30	
	575 V [HP]	1-1/2	3	5	7-1/2	10	15	20	7-1/2	10	15	20	25	40	
<b>Maximum rated current of protection device</b> [A]		400							500						

● Under preparation, please contact your local sales office

**UL / CSA Performance Data (140M-..N)**

**Manual Motor Controller**

**(UL 508, CSA C22.2 No..14, for group installation, in connection with a short-circuit protection device)**

		140M-C2N						
		-A16 0.16A	-A25 0.25A	-A40 0.4A	-A63 0.63A	-B10 1A	-B16 1.6A	-B25 2.5A
<b>Max. short-circuit current</b>	480 V [kA]	65	65	65	65	65	65	65
	600 V [kA]	47	47	47	47	47	47	5
<b>Motor load</b>								
1 phase	115 V [HP]	-	-	-	-	-	-	-
	230 V [HP]	-	-	-	-	-	1/10	1/6
3 phase	230 V [HP]	-	-	-	-	-	-	1/2
	460 V [HP]	-	-	-	-	-	3/4	1
	575 V [HP]	-	-	-	-	1/2	3/4	1-1/2
<b>Maximum rated current of protection device</b>	[A]	400						

		140M-D8N					140M-F8N			
		-B25 2.5A	-B40 4A	-B63 6.3A	-C10 10A	-C16 16A	-C25 25A	-C25 25A	-C32 32A	-C45 45A
<b>Max. short-circuit current</b>	480 V [kA]	65	65	65	65	65	25	●	●	●
	600 V [kA]	10	10	10	10	10	5	●	●	●
<b>Motor load</b>										
1 phase	115 V [HP]	-	1/8	1/4	1/2	3/4	1-1/2	1-1/2	2	3
	230 V [HP]	1/6	1/3	1/2	1	2	3	3	5	7-1/2
3 phase	230 V [HP]	1/2	3/4	1-1/2	3	-	7-1/2	7-1/2	10	15
	460 V [HP]	1	2	3	5	10	15	15	20	30
	575 V [HP]	1-1/2	3	5	7-1/2	10	20	20	25	40
<b>Maximum rated current of protection device</b>	[A]	400					500			

● Under preparation, please contact your local sales office

**Bulletin 140M**  
**Manual Motor Controller**  
**Technical Information**

**UL / CSA Performance Data (Transformer protection 140M-..T)**

**Manual Motor Controller**  
**(UL 508, CSA C22.2 No..14, for group installation, in connection with a short-circuit protection device)**

			140M-C2T									
			-A16 0.16A	-A25 0.25A	-A40 0.4A	-A63 0.63A	-B10 1A	-B16 1.6A	-B25 2.5A	-B40 4A	-B63 6.3A	-C10 10A
<b>Max. short-circuit current</b>												
480 V	[kA]		65	65	65	65	65	65	65	65	65	10
600 V	[kA]		47	47	47	47	47	10	10	5	5	5
<b>Motor load</b>												
1 phase	115 V	[HP]	-	-	-	-	-	-	1/8	1/4	1/2	3/4
	230 V	[HP]	-	-	-	-	-	1/10	1/6	1/3	1/2	2
3 phase	230 V	[HP]	-	-	-	-	-	1/2	3/4	1-1/2	3	5
	460 V	[HP]	-	-	-	-	-	3/4	1	2	3	5
	575 V	[HP]	-	-	-	-	1/2	3/4	1-1/2	3	5	7-1/2
<b>Maximum rated current of protection device</b>			400									

			140M-D8T		140M-F8T	
			-C16 16A	-C20 20A	-C25 25A	-C32 32A
<b>Max. short-circuit current</b>						
480 V	[kA]		65	65	●	●
600 V	[kA]		10	5	●	●
<b>Motor load</b>						
1 phase	115 V	[HP]	3/4	1	1-1/2	2
	230 V	[HP]	2	3	-	5
3 phase	230 V	[HP]	-	5	7-1/2	10
	460 V	[HP]	10	-	15	20
	575 V	[HP]	10	15	20	25
<b>Maximum rated current of protection device</b>			400		500	

● Under preparation, please contact your local sales office







**Combination Motor Controller construction Typ E**

(Approval under preparation)



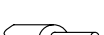
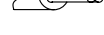



## General Data

	<b>140M-C</b>	<b>140M-D</b>	<b>140M-F</b>
<b>Rated insulation voltage</b> IEC, SEV, VDE 0660	690 V		
UL, CSA	600 V		
<b>Rated impulse withstand voltage</b> $U_{imp}$ /pollution degree	6 kV / 3		
<b>Rated frequency</b>	50/60 Hz, 50Hz, 60 Hz		
<b>Utilization category:</b> -IEC 947-2 (Circuit breaker) -IEC 947-4-1 (Motor starter)	A AC-3		
<b>Life span</b>			
mechanical operations	100 000		30 000
electrical ( $I_e$ max.) operations	100 000		30 000
<b>Switching frequency</b> operations	max. 25 / h. (motor starts)		
<b>Ambient temperature</b>			
storage	- 40 °C ... + 80 °C		
operation	- 25 °C ... + 60 °C		
<b>Resistance to climatic change</b>	IEC 68-2		
<b>Site altitude</b>	to 2000 m N.N.		
<b>Protection class</b>	IP20, when wired		
<b>Resistance to shock</b>	>30 g, 11 ms		under preparation
<b>Resistance to vibration</b>	IEC 68-2		
<b>Rated thermal current <math>I_{th}</math></b> IEC, SEV, VDE 0660 up to 60 °C ambient temperature [A]	0.1...25	1.6...25	6.3...45
<b>Overload protection</b>	IEC 947-4-1 Motor protection (except 140M-C2N, 140M-D8N, 140M-F8N)		
Characteristics			
Ambient temperature compensation	- 20 °C...+ 60 °C		
Phase-failure protection	yes differential release		
<b>Tripclass</b>	10 (except 140M-C2N, 140M-D8N, 140M-F8N)		
<b>Magnetic release</b>			
Response current	fixed setting 13 x $I_e$ max. (for 140M-C2E, 140M-D8E, 140M-F8E, 140M-C2N, 140M-D8N, 140M-F8N) 16...20 x $I_e$ max. (for 140M-C2T, 140M-D8T, 140M-F8T) $I_e$ max. = maximum values of setting ranges		
<b>Total power loss <math>P_v</math></b> Circuit Breaker at rated load operating temperature [W]	6...8	6...8	9...16

**General Data**





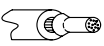
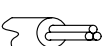
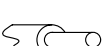
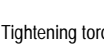

	140M-C	140M-D	140M-F
Conformity to standards	IEC 947; EN 60947; UL 508; CSA 22.2 Teil 14		
Approvals	CE, UL, CSA		
Terminal parts Type of terminals			
Screwdriver	Pozidriv No. 2 / Blade No. 3		Pozidriv No. 2 / Blade No. 4
 1.conductor [mm <sup>2</sup> ] / [AWG]	1...4 / No. 16...12		2.5...16 / No.14...6
 2.conductor [mm <sup>2</sup> ] / [AWG]	1...4 / No. 16...12		2.5...10 / No. 14...8
 1.conductor [mm <sup>2</sup> ] / [AWG]	1...6 / No. 16...8		2.5...25 / No. 14...4
 2.conductor [mm <sup>2</sup> ] / [AWG]	1...6 / No. 16...8		2.5...16 / No. 14...6
 1.conductor [mm <sup>2</sup> ] / [AWG]	1.5...6 / No. 16...8		2.5...25 / No. 14...4
 2.conductor [mm <sup>2</sup> ] / [AWG]	1.5...6 / No. 16...8		2.5...16 / No. 14...6
Tightening torque [Nm] / [lb-in]	1...2.5 / 8.9...22		1.5...3.5 / 13...31

**Accessories for Circuit Breaker 140M**

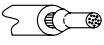
	Auxiliary contacts for front mounting 140M-C-AFA..., 140M-C-AFAR...			Auxiliary contacts for right side mounting 140M-C-ASA..., 140M-C-ASAR...					
Rated thermal current $I_{th}$ at 40 °C ambient temperature [A]	5			10					
at 60 °C ambient temperature [A]	4			6					
Contact class coordination according to NEMA (UL/CSA-Standards)	AC	B 300			B 600				
	DC	Q 300			Q 600				
Back-up fuses gG, gL [A]	10			10					
Rated supply current [V]	24	120	240	24	120	240	415	690	
AC-15: [A]	4	3	1.5	6	5	3	2	0.7	
DC-13: [V]	24	120	240	24	120	240	415		
	2	0.5	0.25	2	0.5	0.25	0.15		
Terminal parts Type of terminals									
Screwdriver	Pozidriv No. 2 / Blade No. 3								
 1.conductor [mm <sup>2</sup> ] / [AWG]	0.5...2.5 / No. 18...14								
 2.conductor [mm <sup>2</sup> ] / [AWG]	0.5...2.5 / No. 18...14								
 1.conductor [mm <sup>2</sup> ] / [AWG]	0.75...2.5 / No. 18...14								
 2.conductor [mm <sup>2</sup> ] / [AWG]	0.75...2.5 / No. 18...14								
 1.conductor [mm <sup>2</sup> ] / [AWG]	0.75...2.5 / No. 18...14								
 2.conductor [mm <sup>2</sup> ] / [AWG]	0.75...2.5 / No. 18...14								
Tightening torque [Nm] / [lb-in]	1.5 / 13.3								

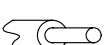
### Accessories for Circuit Breaker 140M

	Undervoltage release for left side mounting 140M-C-UX..	Undervoltage release with 2 auxiliary contacts for left side mounting 140M-C-UC..	Shunt release for left side mounting 140M-C-SN..
<b>Actuating voltage</b>			
Pull-in	0.85...1.1 x $U_s$	0.85...1.1 x $U_s$	0.7...1.1 x $U_s$
Drop-out	0.7...0.35 x $U_s$	0.7...0.35 x $U_s$	0.7...0.35 x $U_s$
<b>Rated control voltage</b>			
min.:	21 V 50 Hz/24 V 60 Hz	21 V 50 Hz/24 V 60 Hz	21 V 50 Hz/24 V 60 Hz
max.:	600 V 50 Hz (UL max. 300 V)	600 V 50 Hz	600 V 50 Hz (UL max. 300 V)
<b>Coil rating</b>			
Pull-in	8.5 VA, 6 W	8.5 VA, 6 W	8.5 VA, 6 W
Hold	3 VA, 1.2 W	3 VA, 1.2 W	3 VA, 1.2 W
On-Time	100 %	100 %	100 %
<b>Terminal parts</b>			
Type of terminals	Pozidriv No. 2 / Blade No. 3		
Screwdriver	0.5...2.5 / No. 18...14		
 1.conductor [mm <sup>2</sup> ] / [AWG]	0.5...2.5 / No. 18...14		
 2.conductor [mm <sup>2</sup> ] / [AWG]	0.75...2.5 / No. 18...14		
 1.conductor [mm <sup>2</sup> ] / [AWG]	0.75...2.5 / No. 18...14		
 2.conductor [mm <sup>2</sup> ] / [AWG]	0.75...2.5 / No. 18...14		
Tightening torque [Nm] / [lb-in]	1.5 / 13.3		

	Busbar feeder terminal 140M-C-WT	Compact busbar 140M-C-W...
<b>Rated thermal current <math>I_{th}</math></b> at 60 °C ambient temperature [A]	63	63
 1.conductor [mm <sup>2</sup> ] / [AWG]	4...16	-
 2.conductor [mm <sup>2</sup> ] / [AWG]	4...10	-
 1.conductor [mm <sup>2</sup> ] / [AWG]	6...25 / No. 14...4	-
 2.conductor [mm <sup>2</sup> ] / [AWG]	6...16 / No. 14...6	-
 1.conductor [mm <sup>2</sup> ] / [AWG]	6...25 / No. 14...4	-
 2.conductor [mm <sup>2</sup> ] / [AWG]	6...16 / No. 14...6	-
Tightening torque [Nm] / [lb-in]	3 / 27	-

### Weights

Description	Type	Weights
Circuit Breaker	140M-C2E-...	317 g
	140M-D8E-...	373 g
	140M-F8E-...	782 g
	140M-C2N-...	315 g
	140M-D8N-...	365 g
	140M-F8N-...	782 g
	140M-C2T-...	315 g
Auxiliary contact	140M-D8T-...	365 g
	140M-F8T-...	782 g
	140M-C-AFA10	10 g
	140M-C-AFA01	
	140M-C-AFA11	
	140M-C-AFA20	
	140M-C-ASA..	15 g
140M-C-AFAR10A..		
140M-C-ASAR..M..		
Undervoltage release	140M-C-ASAM11	
	140M-C-UX.	108 g
	140M-C-SN.	110 g
Anti tamper cover	140M-C-UC.	116 g
	140M-C-CA	2 g

Description	Type	Weights
Lockable rotary handle	140M-C-KN	5 g
	140M-C-KRY	
Locking arrangement	140M-C-M3	30 g
Door coupling handle	140M-C-DN66	123 g
	140M-C-NRY66	
Extension shaft	140M-C-DS	46 g
Legend plate	140M-C-DFC..	4 g
Busbar feeder terminal	140M-C-WT	172 g
	140M-F-WT	
Compact busbars	140M-C-W452	47 g
	140M-C-W453	80 g
	140M-C-W454	104 g
	140M-C-W455	132 g
	140M-C-W542	52 g
	140M-C-W543	86 g
	140M-C-W544	118 g
	140M-C-W545	154 g
	140M-C-W632	56 g
	140M-C-W633	92 g
140M-C-W634	134 g	
140M-C-W635	170 g	



**Type "2" Coordination according to IEC 947-4-1**

- Short-circuit current  $I_q = 50$  kA
- Voltage: 400/415 V, 50 Hz

Standard motors AC-3 at 400/415 V 1500 rpm		Circuit Breaker	Thermal overload release Setting range	Magnetic release Response current	Contactor	$I_{AC-3}$
[kW]	[A]	Cat. No.	[A]	[A]	Cat. No.	[A]
0.06	0.23	140M-C2E-A25	0.16...0.25	3.3	100-C09	9
0.09	0.32	140M-C2E-A40	0.25...0.40	5.2	100-C09	9
0.12	0.41	140M-C2E-A63	0.40...0.63	8.2	100-C09	9
0.18	0.59	140M-C2E-A63	0.40...0.63	8.2	100-C09	9
0.25	0.77	140M-C2E-B10	0.63...1.0	13	100-C09	9
0.37	1.1	140M-C2E-B16	1.0...1.6	21	100-C09	9
0.55	1.5	140M-C2E-B16	1.0...1.6	21	100-C09	9
0.75	1.9	140M-C2E-B25	1.6...2.5	33	100-C09	9
1.1	2.6	140M-C2E-B40	2.5...4.0	52	100-C09	9
1.5	3.4	140M-C2E-B40	2.5...4.0	52	100-C09	9
2.2	4.8	140M-C2E-B63	4.0...6.3	82	100-C09	9
3.0	6.3	140M-C2E-C10	6.3...10.0	130	100-C09	9
4.0	8.2	140M-C2E-C10	6.3... 10.0	130	100-C09	9
5.5	10.9	140M-C2E-C16	10.0...16.0	208	100-C12	12
7.5	14.7	140M-C2E-C16	10.0...16.0	208	100-C16	16
11.0	21.0	140M-D8E-C25	18.0...25.0	325	100-C23	23
15.0	27.9	140M-F8E-C32	23.0...32.0	416	100-C30	30
18.5	34.4	140M-F8E-C45	32.0...45.0	585	100-C37	37
22.0	39.6	140M-F8E-C45	32.0...45.0	585	100-C43	43
30.0	53.6	140-CMN-6300	40.0...63.0	882	100-C60	60
37.0	65.3	140-CMN-9000	63.0...90.0	1260	100-C72	72
45.0	78.2	140-CMN-9000	63.0...90.0	1260	100-C85	85

**Definition Type "2" Coordination according to IEC 947-4-1:**

- The contactor or the starter must not endanger persons or systems in the event of a short-circuit.
- The contactor or the starter must be suitable for further use.
- No damage to the overload relay or other parts may occur with the exception of welding of the contactor or starter contacts provided that these can be easily separated without significant deformation (such as with a screwdriver).

In the event of short-circuit, fast opening, current limiting circuit breakers 140M make it possible to build economical, fully short-circuit coordinated starter combinations in accordance with IEC 947-4-1, coordination type "2".

Coordination type "2" without oversizing of contactors means: Type "1" = Type "2"

## Time / Current Characteristic

### Circuit Breaker 140M

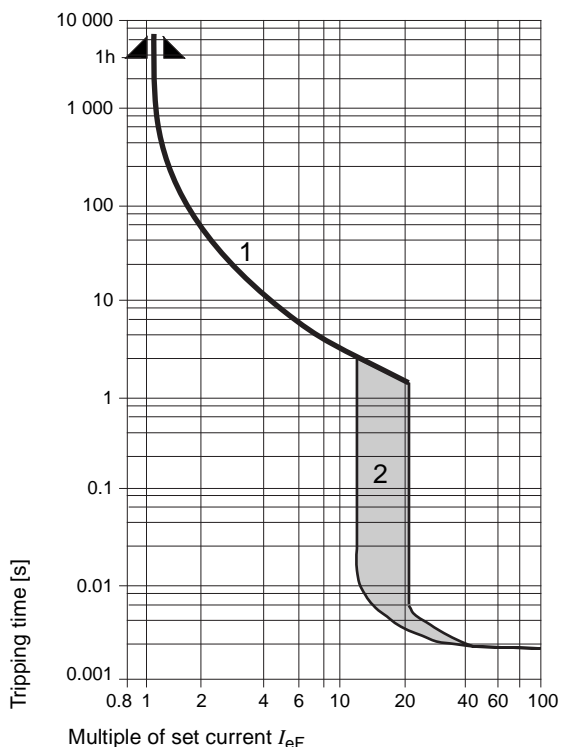

#### 1) Thermal release trip current:

The adjustable inverse bimetal trip reliability protects motors against overloads. The curve shows the mean operating current at an ambient temperature of 20 °C starting from cold. Careful testing and setting ensures effective motor protection even in the case of single-phasing. Overload characteristic also valid for transformer protection.

#### 2) Magnetic release trip current:

The instantaneous magnetic trip has a fixed operating current setting. This corresponds to 13 times the highest setting of the thermal overload trip. (Transformer protection ~20 x  $I_e$  max.) At the upper thermal release setting, this tripping current is 13 (20) times; at a lower setting it is correspondingly higher.

#### Current setting $I_{eF}$ :

The overload trip corresponds to a thermal overload relay in a motor starter conforming to IEC 947-4-1. If a different value is prescribed (e.g. reduced  $I_e$  for cooling medium having a temperature higher than 40 °C or a place of installation higher than 2000 m above sea level), the setting current is equal to the reduced rated current  $I_e$  of the motor.

**Dimensions** in mm (inches)

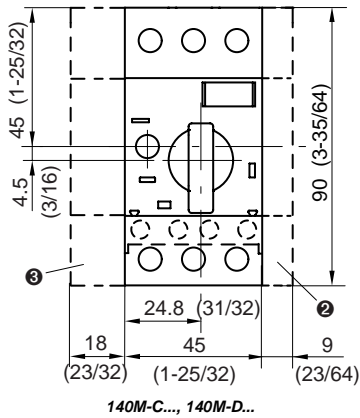

140M-C..., 140M-D...

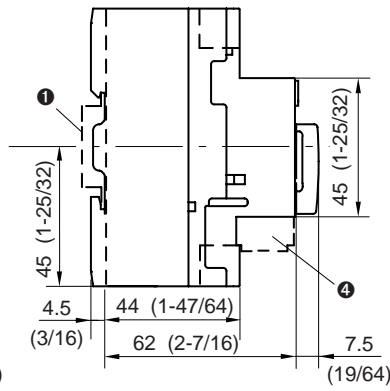

140M-C...

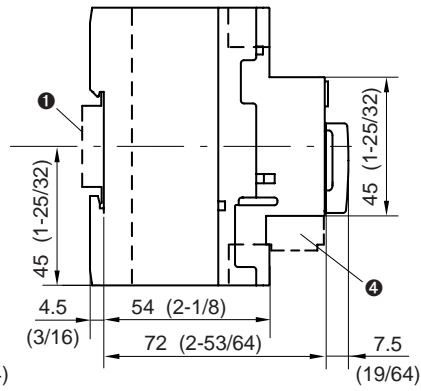

140M-D...

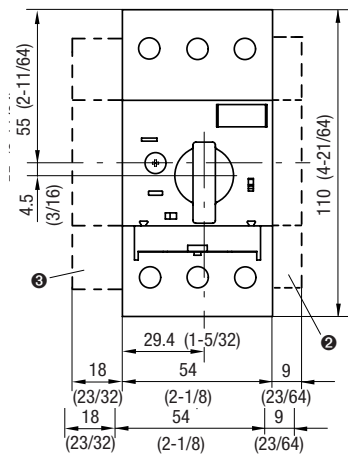

140M-F...

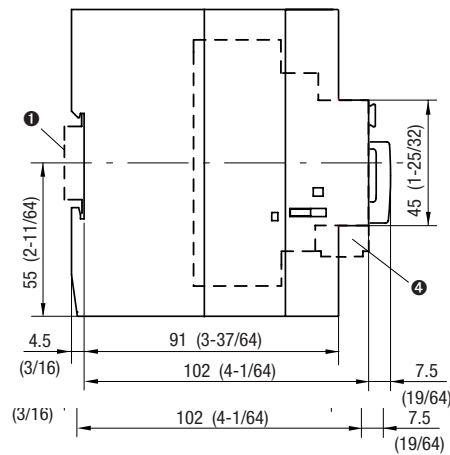

- ❶ Mounting on DIN-rail EN 50 022-35
- ❷ Auxiliary contact (side mounted)
- ❸ Undervoltage release or shunt release
- ❹ Auxiliary contact (front mounted)

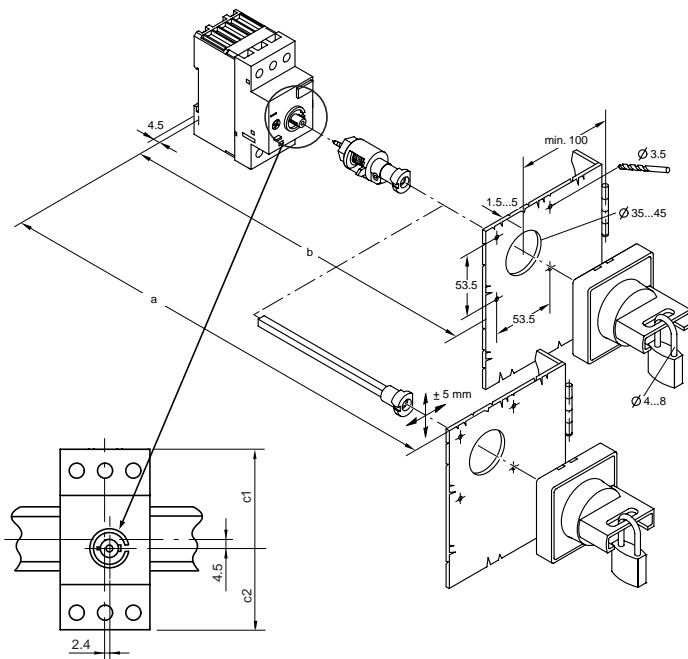

140M-C-D...66

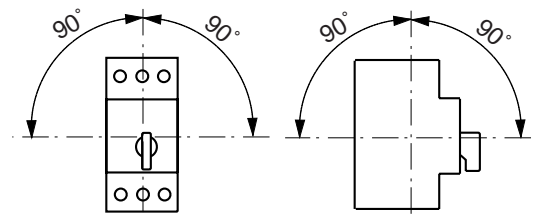

Mounting position 140M-C..., 140M-D..., 140M-F...

	a	b	c1	c2
140M-C2E	117...338	105.5 ±5	49.5	40.5
140M-D8E	126...347	114.5 ±5	49.5	40.5
140M-F8E	148.6...369.6	137.1 ±5	59.35	50.35



Reach us now at [www.rockwellautomation.com](http://www.rockwellautomation.com)

Wherever you need us, Rockwell Automation brings together leading brands in industrial automation including Allen-Bradley controls, Reliance Electric power transmission products, Dodge mechanical power transmission components, and Rockwell Software. Rockwell Automation's unique, flexible approach to helping customers achieve a competitive advantage is supported by thousands of authorized partners, distributors and system integrators around the world.

American Headquarters, 1201 South Second Street, Milwaukee, WI 53204, USA. Tel: (1) 414 223-2000, Fax: (1) 414 223-4444  
European Headquarters, Avenue Hermine Claes, 48, 1180 Brussels, Belgium. Tel: (32) 2 883 48 80, Fax: (32) 2 883 09 40  
Asia Pacific Headquarters, 27/F Chicago Centre, 281A Midland Road, Connaught Place, Hong Kong. Tel: (852) 2357 4765, Fax: (852) 2408 1840

