

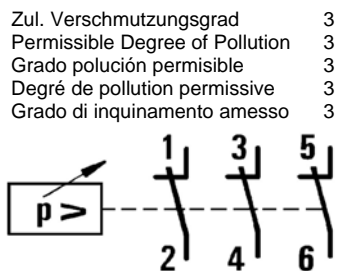

Max. zul. Motorleistung / Max. Motor Performance / Max. Potenza Admissibile del motor / Puissance max. du moteur / Pot. max. ammissibile dei motori

U _e (50 / 60 Hz)	3 (AC-3)	1 (AC-3)
120V	3,0 kW	1,1 kW
230 V	5,5 kW	2,2 kW
400 V	7,5 kW (11 kW)*	-
500 V	7,5 kW (11 kW)*	-
690 V	7.5 kW (15 kW)*	-

*= mit SK 3 H, SK-R3 H - with SK 3 H, SK-R3 H - con SK 3 H, SK-R3 H avec 5K 3 H, SK-R3 H - con SK 3 H. SK-R3 H



SCHALTBILD / WIRING DIAGRAM / ESQUEMA DE CONEXION / SCHEMA DE RACCORDAMENTO / SCHEMA ELETTRICO
3-PHASIG / 3-PHASE / TRIFASICO / TRIPHASE / TRIFASE **1-PHASIG / 1-PHASE / MONOFASICO / MONOPHASE / MONOFASE**

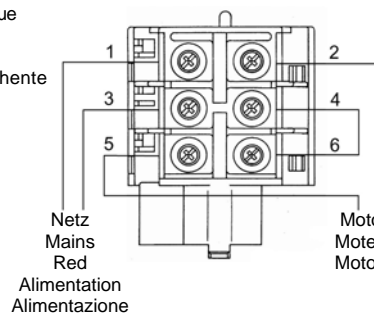
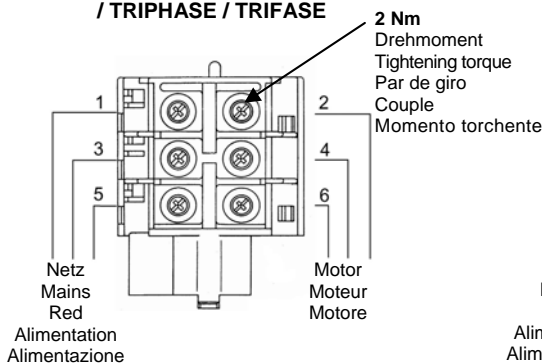

SK-....

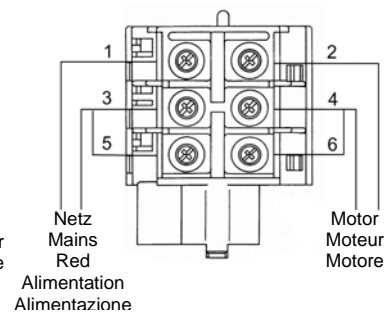

SK-R3/30/2

ACHTUNG:

Vor der Druckeinstellung ist der Druckschalter freizuschalten. Die Druckeinstellung ist nur am montiertem Druckschalter bei unter Druck stehendem Gerät möglich.

ATTENTION:

Adjustments are to be carried out only when the switch is mounted, under pressure and voltage-free.

ATENCION:

Cambios de presión deberán ser efectuados solo con el presóstato montado, bajo presión y libre de tensión.

ATTENTION:

Le réglage de pression ne peut se faire que lorsque l'appareil est monté, sous pression et libre de tension.

ATTENZIONE:

La regolazione va effettuata solo col pressostato montato, sotto pressione e disinserito.

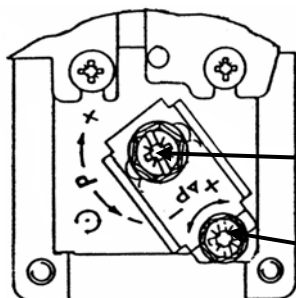

Druckeinstellung / Pressure setting / Ajuste de presión / Réglage de la pression / Regolazione della pressione

Oberer Druckwert / Upper Pressure Setting / Presion de Disparo Superior / Pression Supérieure / Pression di Distacco

Druckdifferenz / Pressure Differential / Diferencial de Presión / Différentiel de Pression / Differenziale di Pressione

Einbau und Anschluß nur durch Fachkraft; nach Anbringung von Zubehör Funktionsüberprüfung durch Elektrofachkraft erforderlich.

Installation and assembly of electrical equipment shall be carried out by qualified personnel only.

Instalación y ensamblaje de equipos eléctricos deberán ser efectuados solamente por personal cualificado.

L'installation et raccordement des appareils doit être effectué par du personnel qualifié.

L'installazione e l'assemblaggio delle parti elettriche vanno eseguite esclusivamente da personale qualificato.

**DRUCKDIAGRAMME / PRESSURE DIAGRAMS / DIAGRAMAS DE REGULACION /
DIAGRAMMES DE REGLAGE / DIAGRAMMI TARATURE**

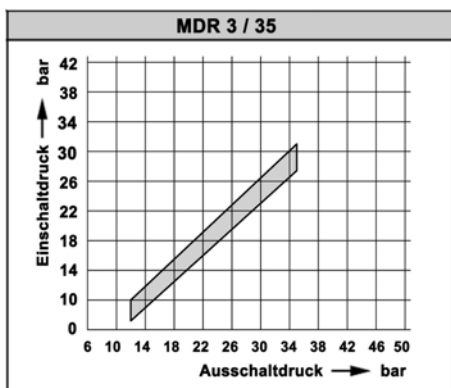
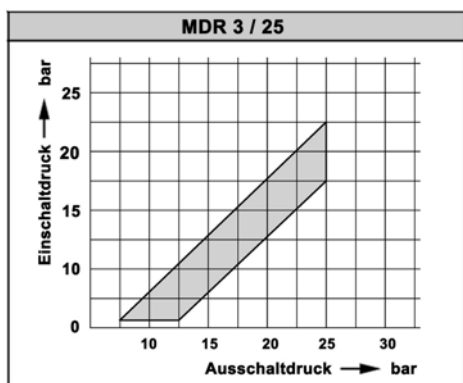
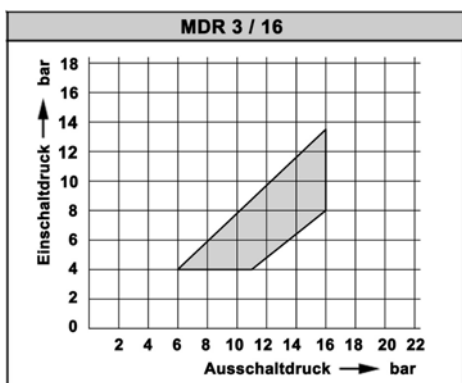
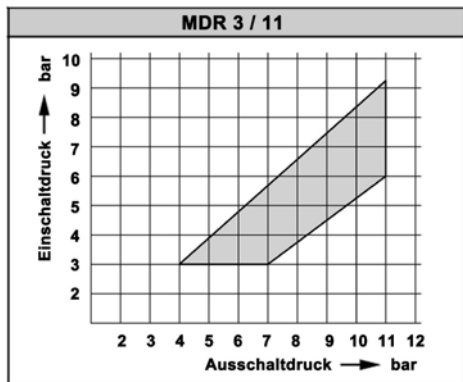
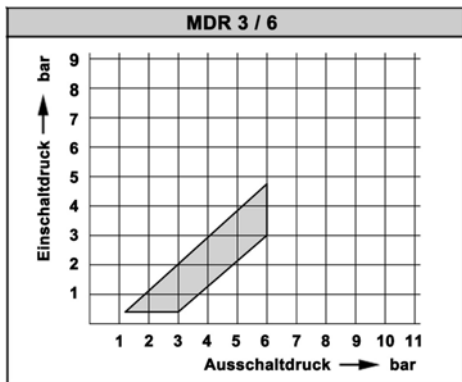

Einschaltdruck
Cut-in pressure
Presión de disparo inferior
Pression de d'enclenchement
Pressione di attacco

Ausschaltdruck
Cut-out pressure
Presión de disparo superior
Pression déclenchement
Pressione di distacco

*MDR 3 EA in Position / I Auto
MDR 3 EA in posición / I Auto
MDR 3 EA en posición / I Auto
MDR 3 EA dans position / I Auto
MDR 3 EA in posizione / I Auto

**ANBAU DER MODULE / MOUNTING ADD-ON MODULES / MONTAJE DE LOS MODULOS /
MONTAGE DES MODULES / MONTAGIO DEI MODULI**

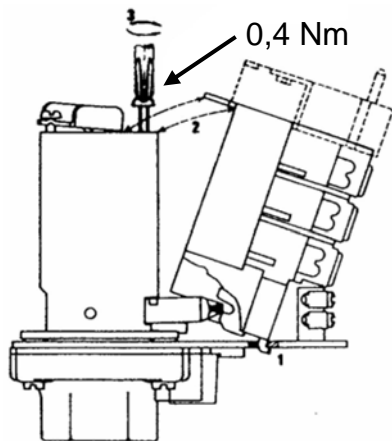

1. - Nase wie im Piktogramm schräg einsetzen
2. - Modul nach hinten kippen
3. - Befestigungsschrauben festdrehen

Wechsel bereits montierter Module:
in umgekehrter Reihenfolge verfahren

1. - Insertar el tetón como en la pictografía
2. - Presionar hacia atrás
3. - Apretar tornillos

Cambiar módulos ya montados: proceder al inverso

1. - Inserire obliquamente il beccuccio come da schema illustrativo
2. - Raddrizzare il modulo
3. - Serrare le viti di fissaggio

Sostituzione moduli: procedere in senso inverso

Haubenbefestigung / Cover fastening / Fijación de la tapa / Fixation par coiffe / Fissaggio coperchio: 1 Nm /

Anbau der Module / Add-on Modules / Módulos Montables / Modules complémentaires / I Moduli:
s. Katalog / see catalogue / ver catálogo / voyez notre catalogue / vedere catalogo

1. - Insert catch as shown
2. - Push the module backwards
3. - Tighten screws

Changing matented modules: proceed in reverse

1. - Insérer le teton en oblique
2. - Pousser le module vers l'arrière
3. - Serrer les vis de fixation

Pour remplacer un module: fait l'opération inverse

Kurzschlußschutzeinrichtung für MDR 3 / Protection against short-circuit for MDR 3 / Protección contra corto circuito para MDR 3 / Protection contre court-circuit pour MDR 3 / Protezione contro corto circuito per MDR 3 Iq ≤ 50kA

Type / Tipo	Koordination Type "1"		Koordination Type "2"	
	Co-ordination Type "1"		Co-ordination Type "2"	
	Coordinación Tipo "1"		Coordinación Tipo "2"	
	Coordination Type "1"		Coordination Type "2"	
	Coordinamento Tipo "1"		Coordinamento Tipo "2"	
Überstromrelais	max. Sich. gl	oder	LS-Schalter (400 V)	
Overload relais	max. Fuses (slow)	or	McB (400 V)	
Relé térmico	max. Fusible (retardado)	o	Automatico (400 V)	
Relais disjoncteur	max. Fusible (retardé)	ou	Disjoncteur Automatiques (400 V)	
Relé termico	max. Fusible (ritardato)	o	Interruttore modulare (400 V)	
	400 V	690 V	400 V	690 V
SK-R3/1,0	80 A	63 A	6 A	4 A
SK-R3/1,6	80 A	63 A	10 A	6 A
SK-R3/2,5	80 A	63 A	20 A	10 A
SK-R3/4,0	80 A	63 A	35 A	20 A
SK-R3 (H)6.3 . 24	80 A	63 A	35 A	35 A
SK-R3 (H)/SK-R3(H-S)	80 A	63 A	35 A	35 A

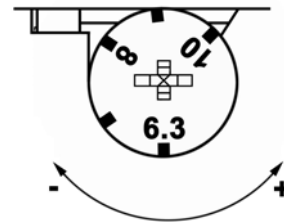

Motorrennstrom am Excenter des SK-R3 Überstromrelais wie abgebildet einstellen.

Use dial to adjust the overload relay SK-R3 to the rated motor current as shown

Usar la excêntrica para ajustar el relé térmico SK-R3 a la corriente nominal del motor como en la pictografía

Déplacé l'excentrique du thermique SK-R3 a la valeur du courant nominal du moteur comme indiqué

Torare la corrente nominale del motore sul relais termico SK-R3 agendo sull'eccentrico come indicato

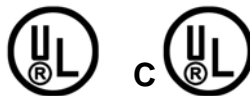

Horsepower Ratings und Short Cimuit Proteeejan acc. to UL 508										
Conrad Block	110 - 120 V		220 - 240 V		440 - 480 V		550 - 600 V		Short Circuit Protection	
Type	1-ph	3-ph	1-ph	3-ph	1-ph	3-ph	1-ph	3-ph	max. V	max. Fuse
SK-R3/1	-	-	-	-	-	½	-	½	600	15 A
SK-R3/1,6	-	-	1/10	½	-	¾	-	1	600	15 A
Sk-R3/2	-	-	1/6	½	½	1	½	1½	600	15 A
Sk-R3/4	½	½	½	1	1	2	1½	3	600	15 A
SK-R3/6,3	¼	¾	½	1½	2	3	2	5	600	25 A
Sk-R3/10	½	1	1½	3	3	5	3	7½	600	40 A
SK-R3/16	1	2	2	5	5	10	7½	10	600	60 A
SK-R3/20	1½	3	3	-	-	-	10	-	600	80 A
SK-R3/24	2	-	-	7½	7½	-	10	-	600	100 A
SK-R3H16	1	2	2	5	5	10	7½	10	600	60 A
SK-R3H/20	1½	3	3	-	-	-	10	15	600	80 A
SK-R3H/24	2	-	-	7½	7½	15	10	20	600	100 A
SK-R3/30/2	2	-	5	-	-	-	-	-	240	110 A

Max. Operating pressure	
MDR 3 / 6	90 psi / 600 kPa
MDR 3 / 11	160 psi / 11100 kPa
MDR 3 / 16	230 psi / 1600 kPa
MDR 3 / 25	360 psi / 12500 kPa
MDR 3 / 35	510 psi / 3500 kPa

* see pressure diagrams

1. Suitable for use an a circuit capable of delivering not more than 5 kA rms symmetrical Amperes, 600 Volts maximum (240 Volts for SK-R3/30/2) when protected by nontime delay fuses as noted in the table above.
2. Suitable for group fusing of 5 kA rms symmetrical Amperes 600 V, 3-ph maximum (SK-R3/30/2 240V. 1-ph max.) when protected by time delay fuses rated max. 100 A.
3. Use 75° copper wire AWG 10 -AWG 14
3. AC Motor Load
5. Break all lines
6. Trip current is 125% of dial setting

30.310.93.001 02.11.2005



Condor Pressure Control GmbH

Warendorfer Straße 47 – 51
D-59320 Ennigerloh

Telefon: +49 (0) 25 87 / 89 – 0
Telefax: +49 (0) 25 87 / 89 - 140

info@condor-cpc.com
www.condor-cpc.com