

1

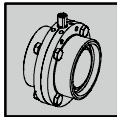

Butterfly Valve (EPDM)
K 580 / K 660 / K 680 without drive unit

		1.4404 (AISI 316 L)	1.4307 (AISI 304 L)			1.4404 (AISI 316 L)	1.4307 (AISI 304 L)
METRIC	ID-NO.	ID-NO.	OD-TUBE	ID-NO.	ID-NO.	ID-NO.	ID-NO.
15	S0000544		1.0"	S0001496	S0010880		
20	S0000546		1.5"	S0001497	S0010881		
25	S0000548	S0002800	2.0"	SUE0001498	S0001524		
32	S0000550		2.5"	SUE0001499	S0010882		
40	S0000552	S0002802	3.0"	S0001500	S0001523		
50	S0000555	S0002803	4.0"	S0001501	S0010883		
65	S0000557	S0002804					
80	S0000533	S0002805					
100	S0000559	S0002806					
125	S0002432						
150	S0002430						

2

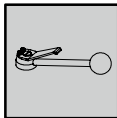

Handle stainless steel handle with intermediate position
Z 590 E (for K 580-588)

SIZES	ID-NO.
DN 15-40/1"-1.5"	SUE2130374
DN 50-100/2"-4	SUE2025319
DN 125-150/5"-6"	0231894

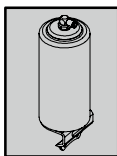

Actuator, Pneumatic incl. mounting set for 2 proximity switches M12
Z 590 E (for K 580-588)

3

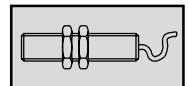

Proximity switches
 Chapter 4.2

		air to open-spring to close	spring to open-air to close	air to open-air to close
SIZES	ID-NO.	ID-NO.	ID-NO.	ID-NO.
DN 15-20	2701900	2705103	2701903	
DN 25-40/1"-1.5	SUE2701901	SUE2705104	SUE2701904	
DN 50-100/2"-4	SUE2701902	SUE2705105	SUE2701905	
DN 125-150/5"-6"	2003805	2146332	2004104	

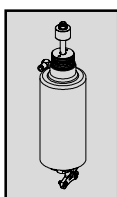

Actuator, Pneumatic incl. mounting set for IntelliTop2.0
Z 690 I2.0

3

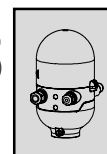

IntelliTop 2.0
 Chapter 4.1

		air to open-spring to close	spring to open-air to close	air to open-air to close
SIZES	ID-NO.	ID-NO.	ID-NO.	ID-NO.
DN 15-20	2707045	2707173	2707046	
DN 25-40/1"-1.5	SUE2707042	2707065	2707047	
DN 50-100/2"-4	SUE2707043	2707066	2707048	
DN 125-150/5"-6"	SUE2311438	2146333	2146334	

4

Additional Charge for completely mounted Valve

EXECUTION	ADD. CHARGE
Handle	
Actuator	

BUTTERFLY VALVES, MALE/SLOTTED NUT AND LINER

3.1

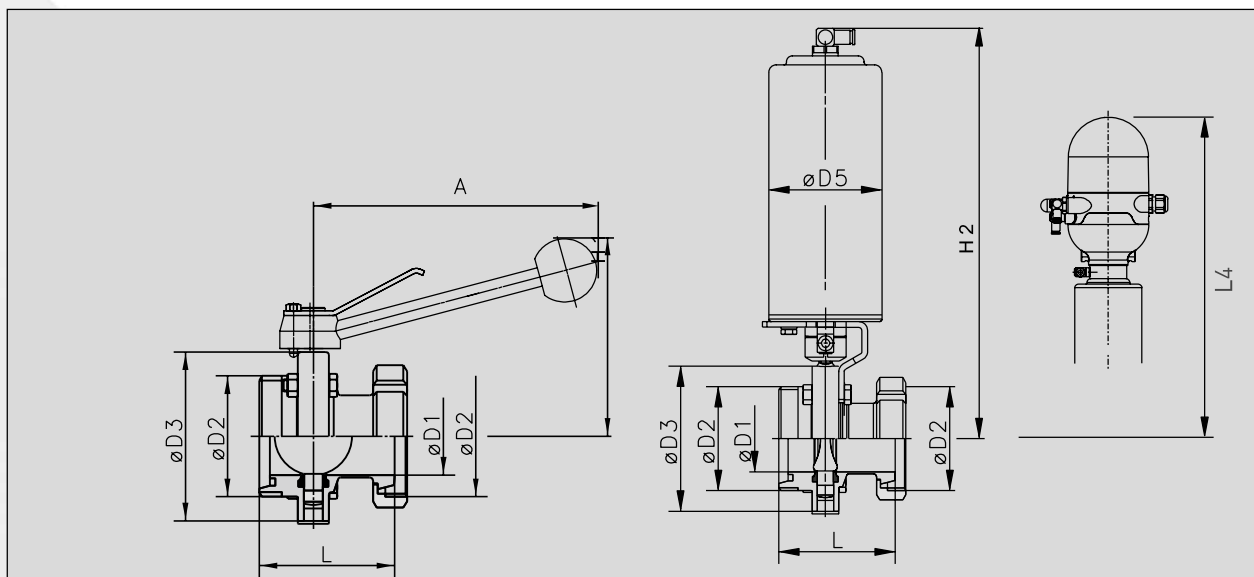

K 581
manually operated
Male/slotted nut and liner

K 661 / K 681 *
pneumatically operated
Male/slotted nut and liner

METRIC	ØD1	ØD2	ØD3	ØD5	A	H1	H2	L	L4	kg
15	16	Rd 34 x 1/8"	62.5	88	150	92	273	71.5	465	0.9 / 4.5
20	20	Rd 44 x 1/6"	70	88	150	96	276	77.5	465	1.3 / 4.9
25	26	Rd 52 x 1/6"	84	88	150	103	283	81.5	476	1.7 / 5.2
32	32	Rd 58 x 1/6"	90	88	150	106	286	84.0	479	1.8 / 5.4
40	38	Rd 65 x 1/6"	96	88	150	109	289	85.5	482	2.0 / 5.6
50	50	Rd 78 x 1/6"	109	88	177	126	296	87.5	489	2.5 / 6.1
65	66	Rd 95 x 1/6"	126	88	177	135	304	93.5	497	3.4 / 7.0
80	81	Rd 110 x 1/4"	141	88	177	142	312	121.5	505	4.4 / 7.9
100	100	Rd 130 x 1/4"	161	88	177	152	323	128.5	516	5.6 / 9.2
125	125	Rd 160 x 1/4"	200	127	220	180	392	148.0	590	
150	150	Rd 190 x 1/4"	230	127	220	195	407	161.0	605	

* Please order SMS or RJT specific males on request

1

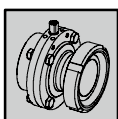

Butterfly Valve (EPDM)

K 581 / K 661 / K 681 without drive unit

1.4404 (AISI 316 L)

1.4307 (AISI 304 L)

METRIC	ID-NO.	ID-NO.
15	S0000697	
20	S0000699	
25	S0000687	S0002914
32	S0000701	
40	S0000703	S0002915
50	S0000705	S0002916
65	S0000707	S0002917
80	S0000709	S0002918
100	S0000695	S0002919
125	S0004558	
150	S0004559	

2

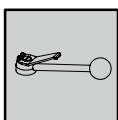

Handle stainless steel handle with intermediate position

Z 590 E (for K 580-588)

SIZES

ID-NO.

DN 15-40/1"-1.5"	SUE2130374
DN 50-100/2"-4	SUE2025319
DN 125-150/5"-6"	0231894

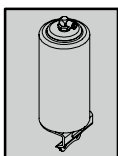

Actuator, Pneumatic incl. mounting set for 2 proximity switches M12

Z 590 E (for K 580-588)

3

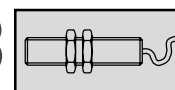

Proximity switches
Chapter 4.2

air to open-spring to close

spring to open-air to close

air to open-air to close

SIZES	ID-NO.	ID-NO.	ID-NO.
DN 15-20	2701900	2705103	2701903
DN 25-40/1"-1.5	SUE2701901	SUE2705104	SUE2701904
DN 50-100/2"-4	SUE2701902	SUE2705105	SUE2701905
DN 125-150/5"-6"	2003805	2146332	2004104

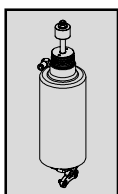

Actuator, Pneumatic incl. mounting set for IntelliTop2.0

Z 690 I2.0

3

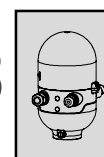

IntelliTop 2.0
Chapter 4.1

air to open-spring to close

spring to open-air to close

air to open-air to close

SIZES	ID-NO.	ID-NO.	ID-NO.
DN 15-20	2707045	2707173	2707046
DN 25-40/1"-1.5	SUE2707042	2707065	2707047
DN 50-100/2"-4	SUE2707043	2707066	2707048
DN 125-150/5"-6"	SUE2311438	2146333	2146334

4

Additional Charge for completely mounted Valve

EXECUTION

ADD. CHARGE

Handle
Actuator

BUTTERFLY VALVES, WELDING ENDS

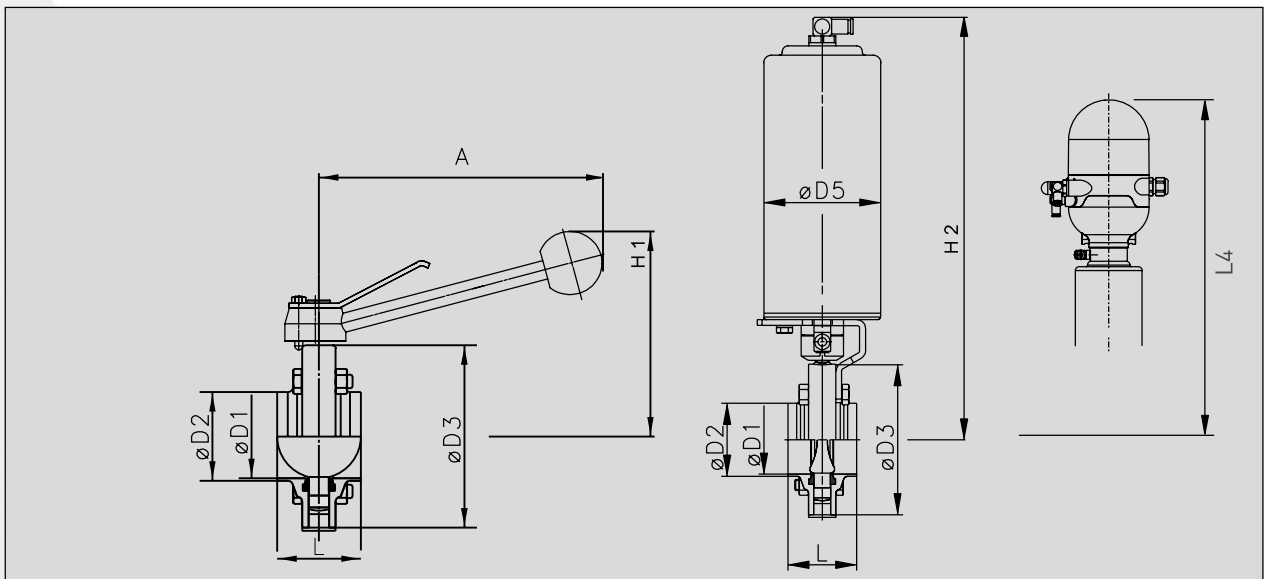

K 582
manually operated
Welding ends

K 662 / K 682
pneumatically operated
Welding ends

METRIC	ØD1	ØD2	ØD3	ØD5	A	H1	H2	L	L4	kg
15	16	19	62.5	88	150	92	273	50	465	0.7 / 4.3
20	20	23	70	88	150	96	276	50	465	0.9 / 4.5
25	26	29	84	88	150	103	283	50	476	1.2 / 4.7
32	32	35	90	88	150	106	286	50	479	1.3 / 4.8
40	38	41	96	88	150	109	289	50	482	1.4 / 4.9
50	50	53	109	88	177	126	296	50	489	1.6 / 5.2
65	66	70	126	88	177	135	304	50	497	2.1 / 5.7
80	81	85	141	88	177	142	312	85	505	2.6 / 6.1
100	100	104	161	88	177	152	323	85	516	3.2 / 6.8
125	125	129	200	127	220	180	392	114	590	
150	150	154	230	127	220	195	407	124	605	
OD-TUBE	ØD1	ØD2	ØD3	ØD5	A	H1	H2	L	L4	kg
1.0"	22.1	25.4	84	88	150	103	283	50	476	1.3 / 4.8
1.5"	34.8	38.1	96	88	150	109	289	50	482	1.5 / 5.0
2.0"	47.5	50.8	109	88	177	126	296	50	489	1.7 / 5.3
2.5"	60.2	63.5	126	88	177	135	304	50	497	2.2 / 5.8
3.0"	72.9	76.2	141	88	177	142	312	85	505	2.7 / 6.2
4.0"	97.4	101.6	161	88	177	152	323	85	516	3.3 / 6.9

1

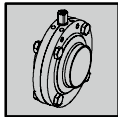

Butterfly Valve (EPDM)
K 582 / K 662 / K 682 without drive unit

1.4404 (AISI 316 L)		1.4307 (AISI 304 L)		1.4404 (AISI 316 L)		1.4307 (AISI 304 L)		1.4404 (AISI 316 L)		1.4307 (AISI 304 L)	
METRIC	ID-NO.	ID-NO.	OD-TUBE	ID-NO.	ID-NO.	ISO	ID-NO.	ID-NO.	ISO	ID-NO.	ID-NO.
15	SUE0001475		1.0"	SUE0001483	S0002590	25	S0004320	S0010976			
20	S0001476		1.5"	S0001484	S0002591	32	S0004321	S0010977			
25	S0001477	S0002814	2.0"	SUE0001485	S0002592	40	S0002414	S0010978			
32	S0001478		2.5"	SUE0001486	S0002593	50	S0002372	S0010979			
40	S0001479	S0002816	3.0"	S0001487	S0002594	65	S0004324	S0010980			
50	S0000554	S0002817	4.0"	SUE0001488	S0002595	80	S0004325	S0010981			
65	S0001480	S0002818				100	S0004326	S0010982			
80	S0001481	S0002819									
100	S0001482	S0002820									
125	S0002241										
150	S0002228										

2

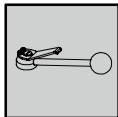

Handle stainless steel handle with intermediate position
Z 590 E (for K 580-588)

SIZES	ID-NO.
DN 15-40/1"-1.5"	SUE2130374
DN 50-100/2"-4"	SUE2025319
DN 125-150/5"-6"	0231894

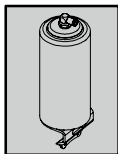

Actuator, Pneumatic incl. mounting set for 2 proximity switches M12
Z 590 E (for K 580-588)

3

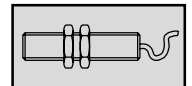

Proximity switches
 Chapter 4.2

		air to open-spring to close	spring to open-air to close	air to open-air to close
SIZES	ID-NO.	ID-NO.	ID-NO.	ID-NO.
DN 15-20	2701900	2705103	2701903	
DN 25-40/1"-1.5	SUE2701901	SUE2705104	SUE2701904	
DN 50-100/2"-4"	SUE2701902	SUE2705105	SUE2701905	
DN 125-150/5"-6"	2003805	2146332	2004104	

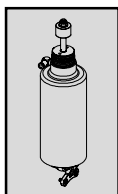

Actuator, Pneumatic incl. mounting set for IntelliTop2.0
Z 690 I2.0

3

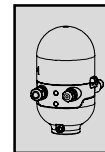

IntelliTop 2.0
 Chapter 4.1

		air to open-spring to close	spring to open-air to close	air to open-air to close
SIZES	ID-NO.	ID-NO.	ID-NO.	ID-NO.
DN 15-20	2707045	2707173	2707046	
DN 25-40/1"-1.5	SUE2707042	2707065	2707047	
DN 50-100/2"-4"	SUE2707043	2707066	2707048	
DN 125-150/5"-6"	SUE2311438	2146333	2146334	

4

Additional Charge for completely mounted Valve

EXECUTION	ADD. CHARGE
Handle	
Actuator	

BUTTERFLY VALVES, MALE/WELDING END

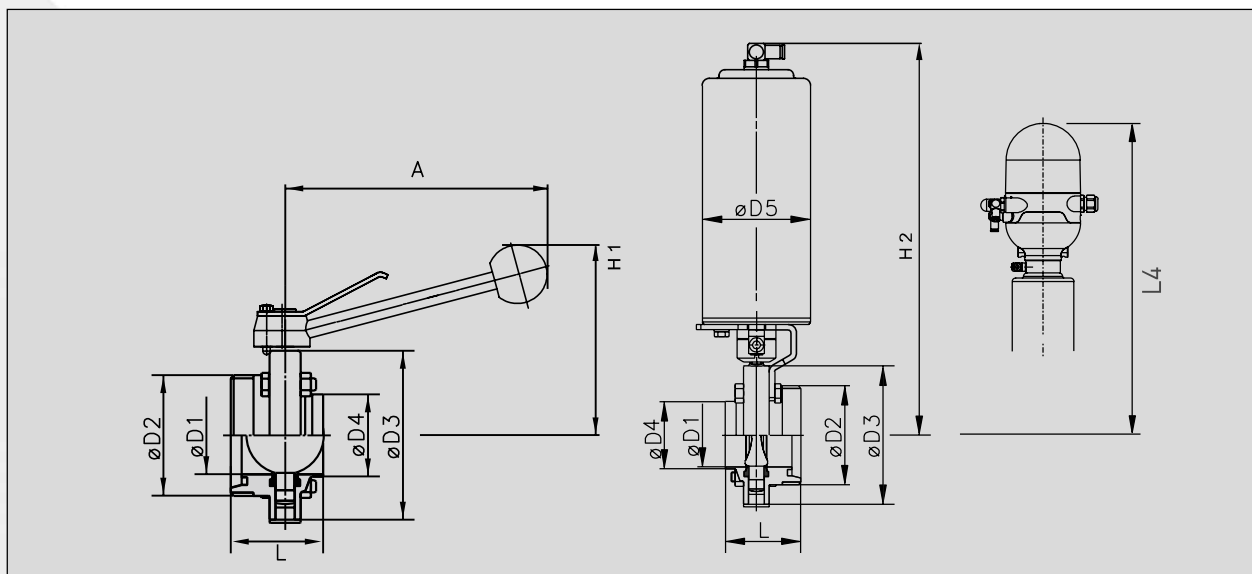

K 585
manually operated
male/welding end

K 665 / K 685
pneumatically operated
male/welding end

METRIC	ØD1	ØD2	ØD3	ØD4	ØD5	A	H1	H2	L	L4	kg
15	16	Rd 34 x 1/8"	62.5	19	88	150	92	273	55	465	0.7 / 4.3
20	20	Rd 44 x 1/6"	62.5	23	88	150	96	276	60	465	0.9 / 4.5
25	26	Rd 52 x 1/6"	84	29	88	150	103	283	60	476	1.2 / 4.7
32	32	Rd 58 x 1/6"	90	35	88	150	106	286	60	479	1.3 / 4.8
40	38	Rd 65 x 1/6"	96	41	88	150	109	289	60	482	1.4 / 4.9
50	50	Rd 78 x 1/6"	109	53	88	177	126	296	60	489	1.6 / 5.2
65	66	Rd 95 x 1/6"	126	70	88	177	135	304	62	497	2.1 / 5.7
80	81	Rd 110 x 1/4"	141	85	88	177	142	312	85	505	2.6 / 6.1
100	100	Rd 130 x 1/4"	161	104	88	177	152	323	85	516	3.2 / 6.8
125	125	Rd 160 x 1/4"	200	129	127	220	180	392	114	590	
150	150	Rd 190 x 1/4"	230	154	127	220	195	407	124	605	
OD-TUBE	ØD1	ØD2	ØD3	ØD4	ØD5	A	H1	H2	L	L4	kg
1.0"	22.1	IDF 37.05 x 1/8"	84	25.4	88	150	103	283	60	476	1.4 / 5.0
1.5"	34.8	IDF 50.57 x 1/8"	96	38.1	88	150	109	289	60	482	1.7 / 5.3
2.0"	47.5	IDF 64.08 x 1/8"	109	50.8	88	177	126	296	60	489	2.1 / 5.6
2.5"	60.2	IDF 77.59 x 1/8"	126	63.5	88	177	135	304	62	497	2.6 / 6.2
3.0"	72.9	IDF 91.11 x 1/8"	141	76.2	88	177	142	312	85	505	3.3 / 6.8
4.0"	97.6	IDF 118.14 x 1/8"	161	101.6	88	177	152	323	85	516	4.0 / 7.6

1

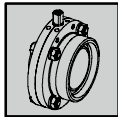

Butterfly Valve (EPDM)
K 585 / K 665 / K 685 without drive unit

1.4404 (AISI 316 L)		1.4307 (AISI 304 L)		1.4404 (AISI 316 L)		1.4307 (AISI 304 L)	
METRIC	ID-NO.	ID-NO.	OD-TUBE	ID-NO.	ID-NO.	ID-NO.	ID-NO.
15	S0000536		1.0"	S0001502		S0020000	
20	S0000531		1.5"	S0001503		S0020001	
25	S0000537	S0002907	2.0"	S0001504		S0020002	
32	S0000538		2.5"	S0001505		S0020003	
40	S0000540	S0002909	3.0"	S0001506		S0020004	
50	S0000541	S0002910	4.0"	S0001507		S0020005	
65	S0000542	S0002911					
80	S0000534	S0002912					
100	S0000558	S0002913					
125	S0004560						
150	S0004561						

2

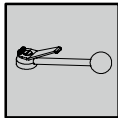

Handle stainless steel handle with intermediate position
Z 590 E (for K 580-588)

SIZES	ID-NO.
DN 15-40/1"-1.5"	SUE2130374
DN 50-100/2"-4"	SUE2025319
DN 125-150/5"-6"	0231894

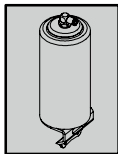

Actuator, Pneumatic incl. mounting set for 2 proximity switches M12
Z 590 E (for K 580-588)

3

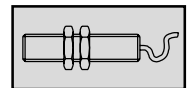

Proximity switches
 Chapter 4.2

air to open-spring to close		spring to open-air to close		air to open-air to close	
SIZES	ID-NO.	ID-NO.	ID-NO.	ID-NO.	ID-NO.
DN 15-20	2701900	2705103		2701903	
DN 25-40/1"-1.5	SUE2701901	SUE2705104		SUE2701904	
DN 50-100/2"-4"	SUE2701902	SUE2705105		SUE2701905	
DN 125-150/5"-6"	2003805	2146332		2004104	

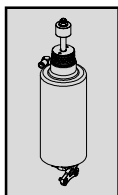

Actuator, Pneumatic incl. mounting set for IntelliTop2.0
Z 690 I2.0

3

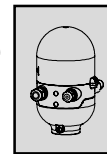

IntelliTop 2.0
 Chapter 4.1

air to open-spring to close		spring to open-air to close		air to open-air to close	
SIZES	ID-NO.	ID-NO.	ID-NO.	ID-NO.	ID-NO.
DN 15-20	2707045	2707173		2707046	
DN 25-40/1"-1.5	SUE2707042	2707065		2707047	
DN 50-100/2"-4"	SUE2707043	2707066		2707048	
DN 125-150/5"-6"	SUE2311438	2146333		2146334	

4

Additional Charge for completely mounted Valve

EXECUTION	ADD. CHARGE
Handle	
Actuator	

BUTTERFLY VALVES

SANDWICH STYLE BETWEEN SMALL FLANGES

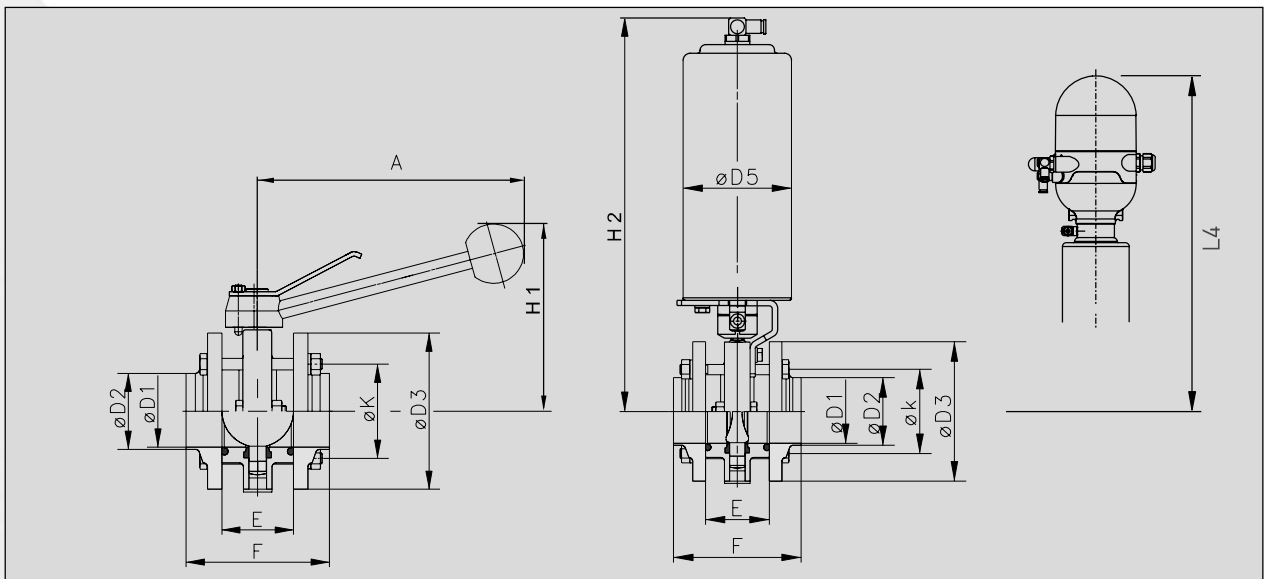

K 587
manually operated

K 667 / K 687
pneumatically operated

sandwich style between small flanges (wafer type)

METRIC	ØD1	ØD2	ØD3	ØD5	A	H1	H2	E	F	Øk	L4	kg
15	16	19	62.5	88	150	92	273	50	100	50	465	1.3 / 4.9
20	20	23	62.5	88	150	92	276	50	100	50	465	1.4 / 5.0
25	26	29	84	88	150	103	283	50	100	67	476	2.3 / 5.9
32	32	35	90	88	150	106	286	50	100	73	479	2.5 / 6.1
40	38	41	96	88	150	109	289	50	100	80	482	2.8 / 6.3
50	50	53	106	88	177	126	296	50	100	93	489	3.4 / 6.9
65	66	70	126	88	177	135	304	50	100	110	497	4.1 / 7.7
80	81	85	141	88	177	142	312	50	100	125	505	4.8 / 8.4
100	100	104	161	88	177	152	323	50	100	145	516	5.9 / 9.5
125	125	129	200	127	220	180	392	60	120	180	590	12.2 / 21.8
150	150	154	230	127	220	195	407	60	120	210	605	16.4 / 25.3
OD-TUBE	ØD1	ØD2	ØD3	ØD5	A	H1	H2	E	F	Øk	L4	kg
1.0"	22.1	25.4	84	88	150	103	283	50	100	67	476	2.4 / 6.0
1.5"	34.8	38.1	96	88	150	109	289	50	100	80	482	2.9 / 6.4
2.0"	47.5	50.8	109	88	177	126	296	50	100	93	489	3.5 / 7.0
2.5"	60.2	63.5	126	88	177	135	304	50	100	110	497	4.2 / 7.8
3.0"	72.9	76.2	141	88	177	142	312	50	100	125	505	4.9 / 8.5
4.0"	97.4	101.6	161	88	177	152	323	50	100	145	516	6.0 / 9.6

BUTTERFLY VALVES

SANDWICH STYLE BETWEEN SMALL FLANGES

1

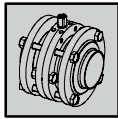

Butterfly Valve (EPDM)
K 587 / K 667 / K 687 without drive unit

1.4404 (AISI 316 L) | 1.4307 (AISI 304 L)

1.4404 (AISI 316 L) | 1.4307 (AISI 304 L)

1.4404 (AISI 316 L) | 1.4307 (AISI 304 L)

METRIC	ID-NO.	ID-NO.
15	S0000642	
20	S0000711	
25	S0000641	S0002828
32	S0000712	
40	S0000713	S0002830
50	S0000563	S0002831
65	S0000714	S0002832
80	S0000564	S0002833
100	S0000715	S0002834
125	S0001769	S0010922
150	S0001770	S0010923

OD-TUBE	ID-NO.	ID-NO.
1.0"	S0000813	S0010997
1.5"	S0000814	S0010998
2.0"	S0000815	S0002942
2.5"	S0000816	2153644
3.0"	S0000817	S0010999
4.0"	S0000818	2153642

ISO	ID-NO.	ID-NO.
25	S0004393	S0020083
32	S0004599	S0020084
40	S0004394	S0020085
50	S0002410	S0020086
65	S0004395	S0020087
80	S0004396	S0020088
100	S0004397	S0020089

2

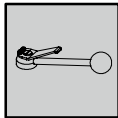

Handle stainless steel handle with intermediate position
Z 590 E (for K 580-588)

SIZES	ID-NO.
DN 15-40/1"-1.5"	SUE2130374
DN 50-100/2"-4	SUE2025319
DN 125-150/5"-6"	0231894

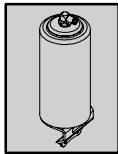

Actuator, Pneumatic incl. mounting set for 2 proximity switches M12
Z 590 E (for K 580-588)

3

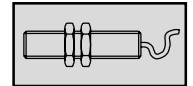

Proximity switches
 Chapter 4.2

air to open-spring to close	spring to open-air to close	air to open-air to close
-----------------------------	-----------------------------	--------------------------

SIZES	ID-NO.	ID-NO.	ID-NO.
DN 15-20	2701900	2705103	2701903
DN 25-40/1"-1.5	SUE2701901	SUE2705104	SUE2701904
DN 50-100/2"-4	SUE2701902	SUE2705105	SUE2701905
DN 125-150/5"-6"	2003805	2146332	2004104

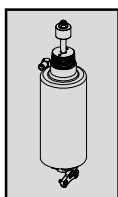

Actuator, Pneumatic incl. mounting set for IntelliTop2.0
Z 690 I2.0

3

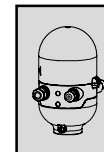

IntelliTop 2.0
 Chapter 4.1

air to open-spring to close	spring to open-air to close	air to open-air to close
-----------------------------	-----------------------------	--------------------------

SIZES	ID-NO.	ID-NO.	ID-NO.
DN 15-20	2707045	2707173	2707046
DN 25-40/1"-1.5	SUE2707042	2707065	2707047
DN 50-100/2"-4	SUE2707043	2707066	2707048
DN 125-150/5"-6"	SUE2311438	2146333	2146334

4

Additional Charge for completely mounted Valve

EXECUTION	ADD. CHARGE
Handle	
Actuator	

BUTTERFLY VALVES, TRI-CLAMP

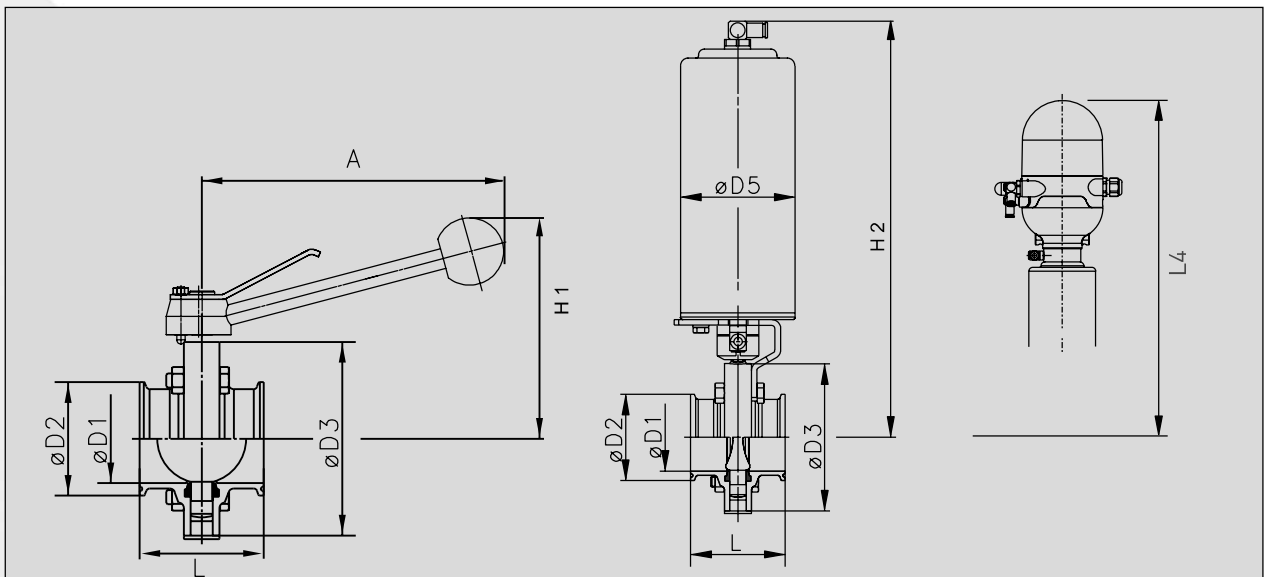

K 588
manually operated
2 x Tri-Clamp

K 668 / K 688
pneumatically operated
2 x Tri-Clamp

METRIC	ØD1	ØD2	ØD3	ØD5	A	H1	H2	L	L4	kg
25	26	50.5	84	88	150	103	283	70	465	1.4 / 5.0
40	38	50.5	96	88	150	109	289	70	465	1.6 / 5.1
50	50	64.0	109	88	150	126	296	70	476	1.9 / 5.4
65	66	91.0	126	88	177	135	304	74	479	2.5 / 6.1
80	81	106.0	141	88	177	142	312	85	482	3.0 / 6.5
100	100	119.0	161	88	177	152	323	85	489	3.6 / 7.2
OD-TUBE	ØD1	ØD2	ØD3	ØD5	A	H1	H2	L	L4	kg
1.0"	22.1	50.5	84	88	150	103	283	70	476	1.5 / 5.1
1.5"	34.8	50.5	96	88	150	109	289	70	482	1.7 / 5.2
2.0"	47.5	64.0	109	88	177	126	296	70	489	2.0 / 5.5
2.5"	60.2	77.5	126	88	177	135	304	74	497	2.6 / 6.2
3.0"	72.9	91.0	141	88	177	142	312	85	505	3.1 / 6.6
4.0"	97.4	119.0	161	88	177	152	323	85	516	3.7 / 7.3

1

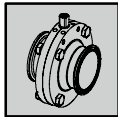

Butterfly Valve (EPDM)
K 588 / K 668 / K 688 without drive unit

		1.4404 (AISI 316 L)	1.4307 (AISI 304 L)			1.4404 (AISI 316 L)	1.4307 (AISI 304 L)
METRIC	ID-NO.	ID-NO.	OD-TUBE	ID-NO.	ID-NO.	ID-NO.	ID-NO.
25	S0001510	S0010926	1.0"	S0001516	S0010946	S0001516	S0010946
40	S0001512	S0010941	1.5"	S0001517	S0010947	S0001517	S0010947
50	S0001495	S0010927	2.0"	S0001518	S0010948	S0001518	S0010948
65	S0001513	S0010928	2.5"	S0001519	S0010949	S0001519	S0010949
80	S0001514	S0010929	3.0"	S0001520	S0010950	S0001520	S0010950
100	S0001515	S0010930	4.0"	S0001521	S0010951	S0001521	S0010951

2

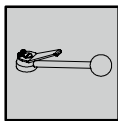

Handle stainless steel handle with intermediate position
Z 590 E (for K 580-588)

SIZES	ID-NO.
DN 15-40/1"-1.5"	SUE2130374
DN 50-100/2"-4	SUE2025319
DN 125-150/5"-6"	0231894

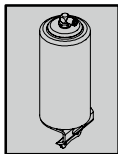

Actuator, Pneumatic incl. mounting set for 2 proximity switches M12
Z 590 E (for K 580-588)

3

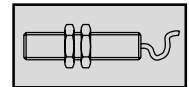

Proximity switches
 Chapter 4.2

		air to open-spring to close	spring to open-air to close	air to open-air to close
SIZES	ID-NO.	ID-NO.	ID-NO.	ID-NO.
DN 15-20	2701900	2705103	2701903	2701903
DN 25-40/1"-1.5	SUE2701901	SUE2705104	SUE2701904	SUE2701904
DN 50-100/2"-4	SUE2701902	SUE2705105	SUE2701905	SUE2701905
DN 125-150/5"-6"	2003805	2146332	2004104	2004104

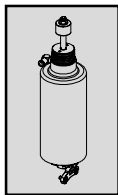

Actuator, Pneumatic incl. mounting set for IntelliTop2.0
Z 690 I2.0

3

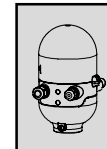

IntelliTop 2.0
 Chapter 4.1

		air to open-spring to close	spring to open-air to close	air to open-air to close
SIZES	ID-NO.	ID-NO.	ID-NO.	ID-NO.
DN 15-20	2707045	2707173	2707046	2707046
DN 25-40/1"-1.5	SUE2707042	2707065	2707047	2707047
DN 50-100/2"-4	SUE2707043	2707066	2707048	2707048
DN 125-150/5"-6"	SUE2311438	2146333	2146334	2146334

4

Additional Charge for completely mounted Valve

EXECUTION	ADD. CHARGE
Handle	
Actuator	