

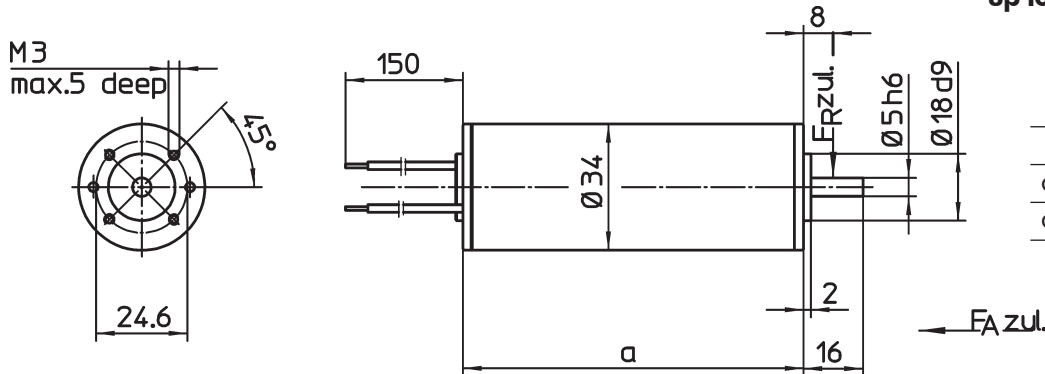

## GNM 21

### DC Motors with permanent magnet field

Motor series GNM 21  
up to 16 Watts output power



Type	Dimension a
GNM 2130C	78
GNM 2145C	94

#### Operation characteristics:

n - Speed  
 $\eta$  - Efficiency  
 $P_1$  - Input power  
 $P_2$  - Output power

GNM2130C, 12V, 6000rpm

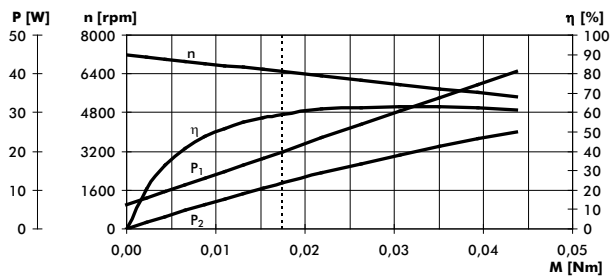

GNM2145C, 12V, 6000rpm

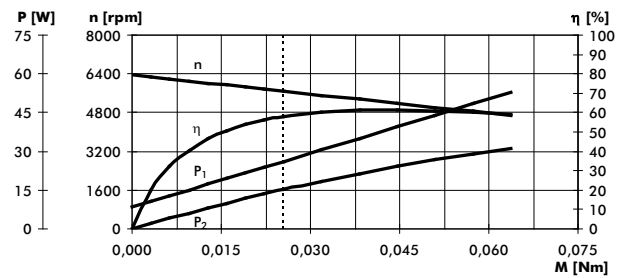

GNM2130C, 24V, 6000rpm

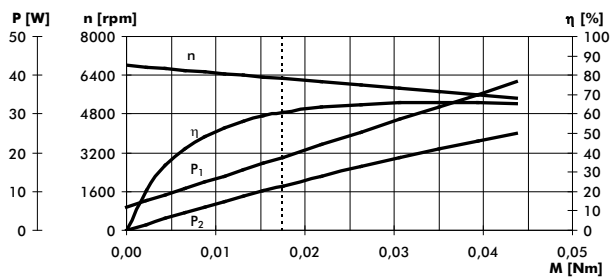

GNM2145C, 24V, 6000rpm

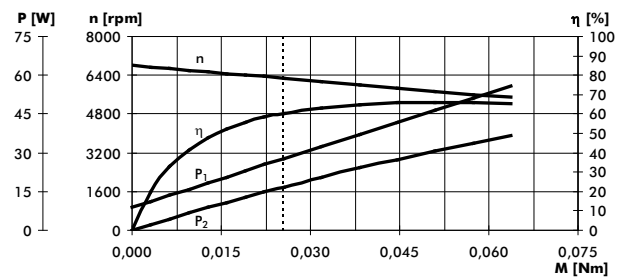

#### Control characteristics :

$n=f(M)$  - Speed as a torque function  
 $n=f(U)$  - Speed as a supply voltage function

GNM2130C, 24V, 6000rpm

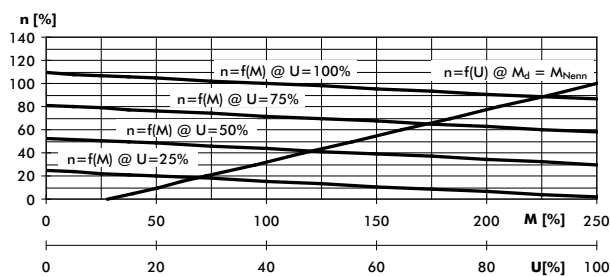

GNM2145C, 24V, 6000rpm

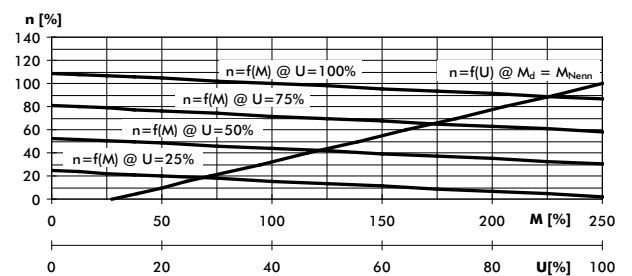

type series	GNM 2130		GNM 2145	
	6000	C 6000	6000	C 6000
nominal speed	rpm	12	24	24
nominal voltage	V	12	24	24
nominal current	A	1,7	0,8	1,15
nominal power	W	11	11	16
operation acc. to VDE 0530				S1
protection acc. to VDE 0530				IP 21
connection				free leads
rotating direction				reversible
design				
<b>mechanical data:</b>				
mass moment of inertia	kgm <sup>2</sup>	0,0175	0,0175	0,0043*10 <sup>-3</sup>
nominal torque	Nm	0,16	0,2	0,0255
starting torque	Nm	0,022	0,022	0,21
max. continuous torque at stall	Nm	396	315	0,03
speed regulation constant	N <sup>-1</sup> cm <sup>-1</sup> rpm	13,3	10,5	265
mechanical time constant	ms	0,008	0,008	12,1
friction torque	Nm	0,078	0,078	9,4
rotor weight	kg	0,275	0,275	0,012
motor weight	kg			0,103
ball bearings				0,35
F <sub>r</sub> (allowable radial shaft load)		625/625	625/625	625/625
F <sub>a</sub> (allowable axial shaft load)		50	50	50
		20	20	20
<b>electrical data:</b>				
armature resistance	Ω	0,9	3,7	0,71
armature inductance	mH	0,63	2,7	0,4
terminal resistance	Ω	0,97	3,45	0,81
voltage constant	V/1000 rpm	1,6	3,4	1,8
torque constant	Nm/A	0,0153	0,0325	0,017
starting current	A	12,4	7	14,8
max. peak current <sup>1)</sup>	A	18,3	8,8	23,8
electrical time constant	ms	0,65	0,78	0,49
<b>thermal data:</b>				
max. ambient temperature	°C	40	40	40
insulation class acc. to VDE 0530		F	F	F
thermal time constant	min	15	15	15
temperature-rise without cooling	K/W	6,6	6,6	6,4

Tolerances acc. to standard VDE 0530. ± 10 % is valid for not VDE mentioned tolerances.

The values mentioned in the table are valid for supply with DC voltage with allowable harmonic content up to 5%. For undulatory current with increased harmonic content the rated motor values must be multiplied by 0,7.

<sup>1)</sup> The values are valid for operation in temperature-ranges from 0 up to 40°C and it is not allowed to exceed them, even not for a short-time, to avoid magnet-weakening.

**Motor design:**

Brushed 2-pole DC motor with permanent magnet field.

Flange mounting with 4 threads (see drawing).

Rotating direction:

The rotating direction can be changed by inverting the connections.

1. Order example

Motor

GNM 2130C

24 V, 6000 rpm, 11 W

Special designs on request.