

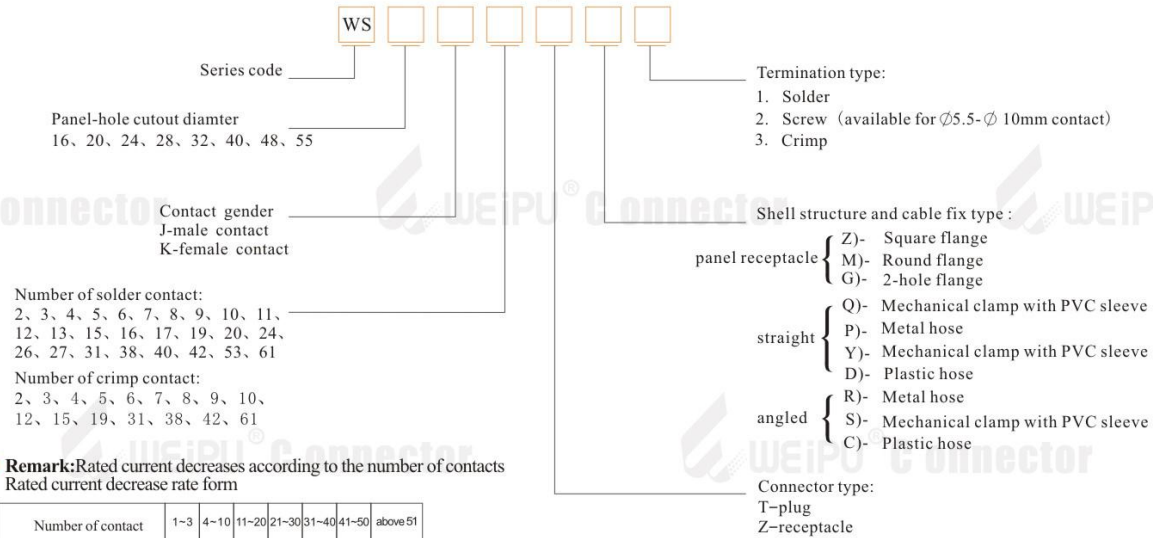

● **WS Series**

Part number system



● **Remark:**Rated current decreases according to the number of contacts
Rated current decrease rate form

Number of contact	1-3	4-10	11-20	21-30	31-40	41-50	above 51
Decrease rate %	0	10	20	30	40	50	60

The plugs and receptacles are available with male contact or female contact

Material and spec

Coupling	Threaded coupling
Shell material	Zinc alloy with chrome plating
Insert material	PPS max temperature 260 °C , fire resistance: V-0
Contact material	Brass with gold plating
Termination	$\varnothing 1$ - $\varnothing 3.5$ mm Solder, $\varnothing 5.5$ - $\varnothing 10$ mm screw, crimp
Mating cycle	>500
Temperature range	-40°C~+85°C
IP Rating	For indoor only

● WS Series Mating diagram

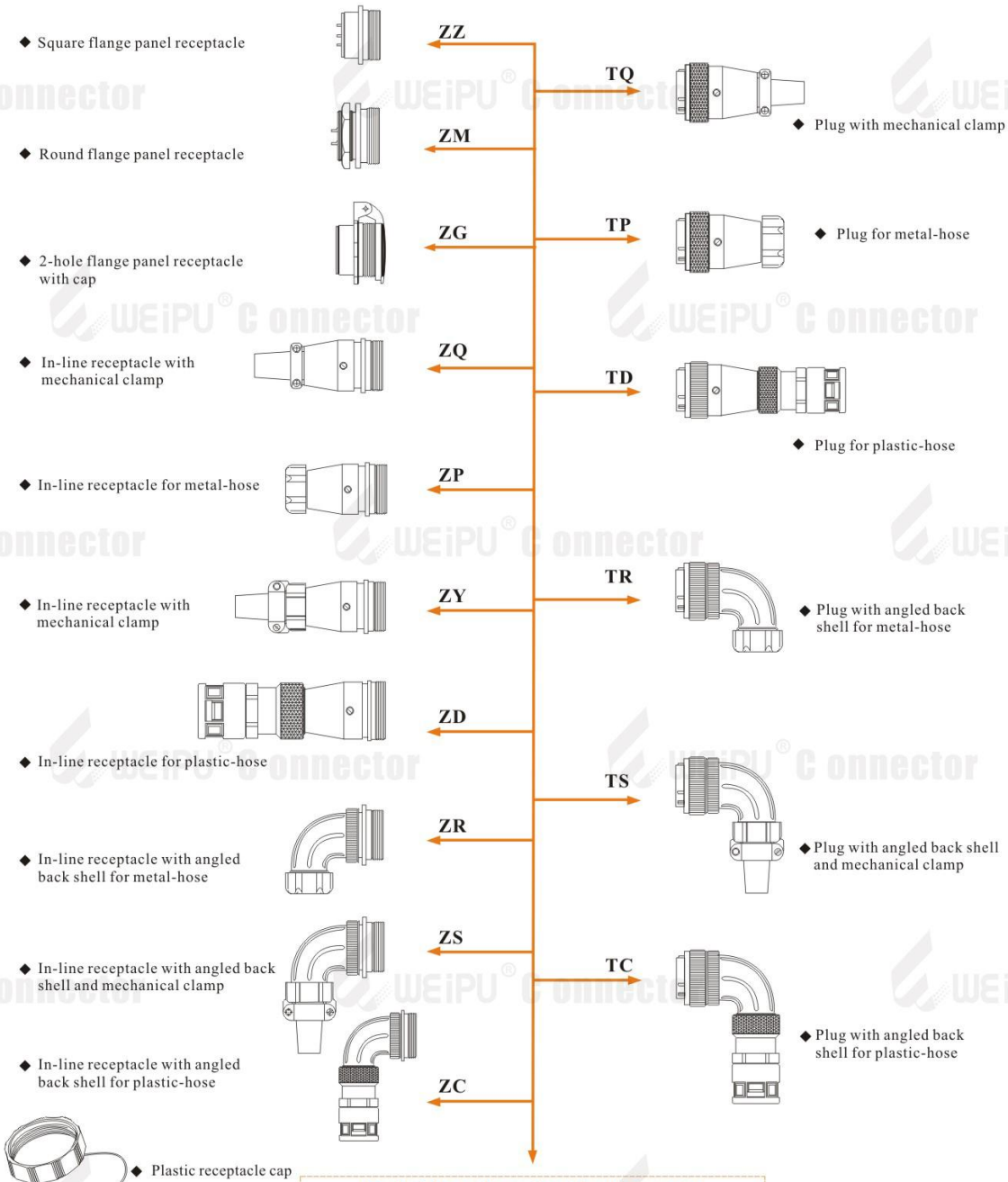

Each side can be male or female contact
 ★ Solder contact arrangement and spec see P47-P48
 ★ Crimp contact arrangement and spec see P49-P52



● Square flange panel receptacle : ZZ

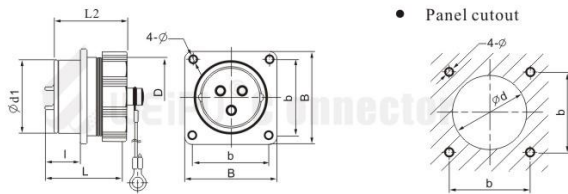

★ Solder contact arrangement and spec see P47-P48 ★ Crimp contact arrangement and spec see P49-P52

Dimension (mm)	WS16	WS20	WS24	WS28	WS32	WS40	WS48	WS55
∅d1	16	20	24	28	32	40	48	55
D	M18X1	M22X1	M26X1	M30X1	M35X1.5	M44X1.5	M52X1.5	M59X1.5
I	13	14	15	15	18.6	20.5	20.5	20.5
L	26	28	28	28	38.2	39.7	39.7	39.7
b	20	22	26	30	32	40	48	52
B	26	29	32	36	42	50	58	64
∅d	16.5	20.5	24.5	28.5	32.5	40.5	48.5	55.5
∅	3.5	3.5	3.5	3.5	3.5	4.5	4.5	4.5
L2	22	23	23	23	34	34	34	34

● Round flange panel receptacle: ZM

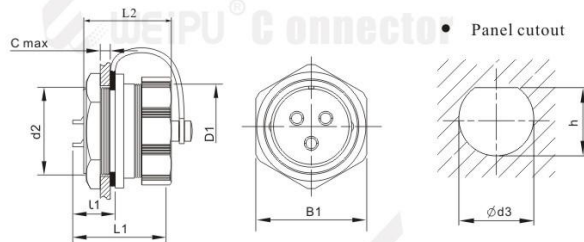

Dimension (mm)	WS16	WS20	WS24	WS28
d2	M16X1	M20X1	M24X1	M28X1
D1	M18X1	M22X1	M26X1	M30X1
C	5	5	5	5
L1	13	14	15	15
L1	26	28	28	28
B1	21	25	29	33
∅d3	16	20	24	28
h	15.4	19.4	23.2	26.9
L2	22	23	23	23



- 2-hole flange panel receptacle with cap: ZG

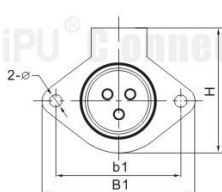
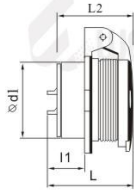

- Panel cutout

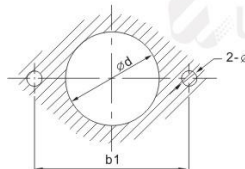

★ Solder contact arrangement and spec see P47-P48 ★ Crimp contact arrangement and spec see P49-P52

Dimension (mm)	WS16	WS20	WS24	WS28	WS32	WS40	WS48	WS55
$\varnothing d$	16.5	20.5	24.5	28.5	32.5	40.5	48.5	55.5
$\varnothing d1$	16	20	24	28	32	40	48	55
$l1$	13	14	15	15	18.1	20.5	20.5	20.5
L	30	32.3	32.3	32.3	42.2	42.2	42.2	43.2
$b1$	30	35	40	45	55	65	80	85
$B1$	38	44	50	55	67	77	92	98
H	32.5	33.5	40.5	45.5	52.5	63.5	74.5	80
\varnothing	3.5	4.5	4.5	4.5	5.5	5.5	5.5	6.5
$L2$	22	23	23	23	34	34	34	34

- In-line receptacle with mechanical clamp: ZQ

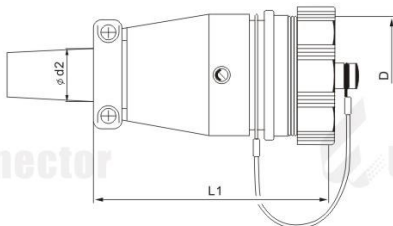

Dimension (mm)	WS16	WS20	WS24	WS28	WS32	WS40	WS48	WS55
D	M18X1	M22X1	M26X1	M30X1	M35X1.5	M44X1.5	M52X1.5	M59X1.5
$L1$	47.5	52	53	55	69	92	98	100
$d2$ Max	10	11.6	12.4	15.7	19.5	24	24	30



- In-line receptacle for metal-hose: ZP

★ Solder contact arrangement and spec see P47-P48
 ★ Crimp contact arrangement and spec see P49-P52

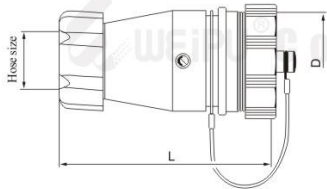

Dimension/mm	WS16	WS20	WS24	WS28	WS32	WS40	WS48	WS55
D	M18X1	M22X1	M26X1	M30X1	M35X1.5	M44X1.5	M52X1.5	M59X1.5
L	53.5	58	59	61	75	99	103	106
Hose size	1/4"	3/8"	3/8"	1/2"	3/4"	1"	I: 1" II: 1 1/4"	1 1/4"

- In-line receptacle with mechanical clamp: ZY

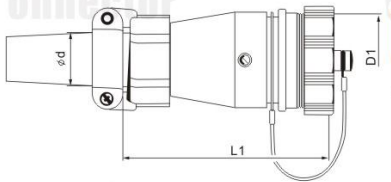

Dimension/mm	WS16	WS20	WS24	WS28	WS32	WS40	WS48	WS55
D1	M18X1	M22X1	M26X1	M30X1	M35X1.5	M44X1.5	M52X1.5	M59X1.5
L1	52.3	59.2	67	70	89.2	94.8	101.8	124.7
ØdMax	10	13	13	17	19	23	I: 23 II: 31	31

- In-line receptacle for plastic-hose: ZD

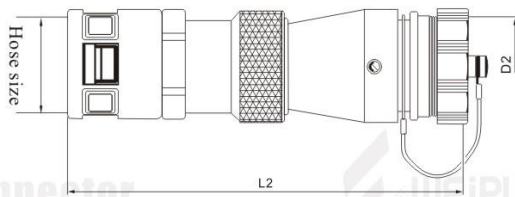

Dimension/mm	WS16	WS20	WS24	WS28	WS32	WS40	WS48	WS55
D2	M18X1	M22X1	M26X1	M30X1	M35X1.5	M44X1.5	M52X1.5	M59X1.5
L2	80	90	97	104	126.7	134	141	160
Adapter size	PG7	PG11	PG11	PG16	PG21	PG29	I: PG29 II: PG36	PG36
Hose size	1/4"	3/8"	3/8"	1/2"	3/4"	1"	I: 1" II: 1 1/4"	1 1/4"



- In-line receptacle with angled back shell for metal-hose: ZR

★ Solder contact arrangement and spec see P47-P48

★ Crimp contact arrangement and spec see P49-P52

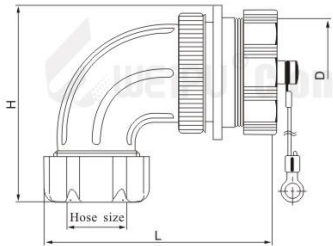

Dimension/mm		WS20	WS24	WS28	WS32	WS40	WS48	WS55
D	—	M22X1	M26X1	M30X1	M35X1.5	M44X1.5	M52X1.5	M59X1.5
L	—	60	60	63	81	88	96	107
H	—	48	51	52	58	70	82	90
Hose size	—	3/8"	3/8"	1/2"	3/4"	1"	1"	1 1/4"

- In-line receptacle with angled back shell and mechanical clamp: ZS

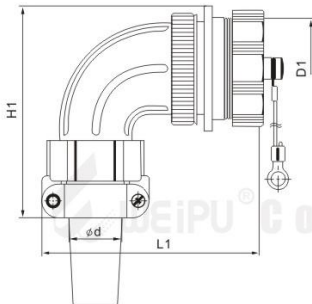

Dimension/mm		WS20	WS24	WS28	WS32	WS40	WS48	WS55
D1	—	M22X1	M26X1	M30X1	M35X1.5	M44X1.5	M52X1.5	M59X1.5
L1	—	60.6	60.4	64.7	82	89.2	96	114.2
H1	—	54.4	56.8	64	72	83.3	94.5	112.3
∅ Max	—	13	13	17	19	23	23	31

- In-line receptacle with angled back shell for plastic-hose: ZC

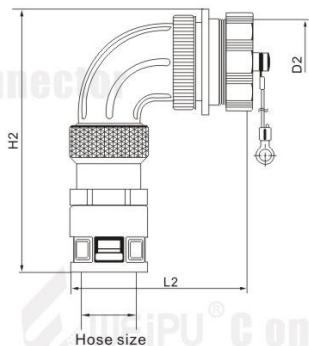

Dimension/mm		WS20	WS24	WS28	WS32	WS40	WS48	WS55
D2	—	M22X1	M26X1	M30X1	M35X1.5	M44X1.5	M52X1.5	M59X1.5
L2	—	60	60	65	82	90	95	110
H2	—	88	88	98	110	120	135	140
Adapter size	—	PG11	PG11	PG16	PG21	PG29	PG29	PG36
Hose size	—	3/8"	3/8"	1/2"	3/4"	1"	1"	1 1/4"



● Plug with mechanical clamp : TQ

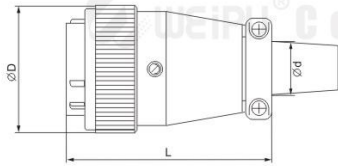

★ Solder contact arrangement and spec see P47-P48
 ★ Crimp contact arrangement and spec see P49-P52

Dimension mm	WS16	WS20	WS24	WS28	WS32	WS40	WS48	WS55
$\varnothing D$	21	25.8	30.5	33.8	39.3	49.3	57	64.5
L	44.8	49.5	53.5	56	70	75.5	85.5	97
$\varnothing d$ Max	10	11.6	12.4	15.7	19.5	24	24	30

● Plug for metal-hose: TP

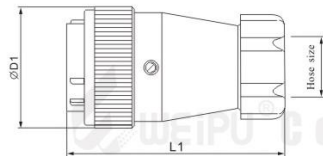

Dimension mm	WS16	WS20	WS24	WS28	WS32	WS40	WS48	WS55
$\varnothing D1$	21	25.8	30.5	33.8	39.3	49.3	57	64.5
L1	48	57	58	61	74	82	90	100
Hose size	1/4"	3/8"	3/8"	1/2"	3/4"	1"	I: 1" II: 1 1/4"	1 1/4"

● Plug for plastic-hose: TD

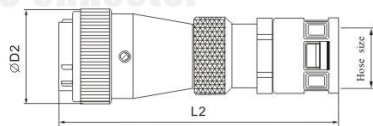

Dimension mm	WS16	WS20	WS24	WS28	WS32	WS40	WS48	WS55
$\varnothing D2$	21	25.8	30.5	33.8	39.3	49.3	57	64.5
L2	63	75	60	63	120	132	138	150
Adapter size	PG7	PG11	PG11	PG16	PG21	PG29	I: PG29 II: PG36	PG36
Hose size	1/4"	3/8"	3/8"	1/2"	3/4"	1"	I: 1" II: 1 1/4"	1 1/4"



- Plug with angled back shell for metal-hose: TR

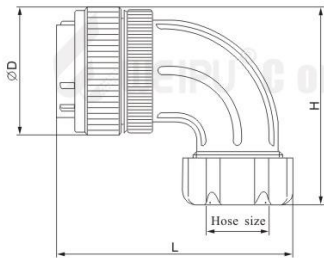

★ Solder contact arrangement and spec see P47-P48

★ Crimp contact arrangement and spec see P49-P52

Dimension mm		WS20	WS24	WS28	WS32	WS40	WS48	WS55
ØD	—	25.6	30	33.8	38.2	46.2	55.8	63
H	—	48	51	52	58	70	82	90
L	—	60	60	63	81	88	96	107
Hose size	—	3/8"	3/8"	1/2"	3/4"	1"	1"	1 1/4"

- Plug with angled back shell and mechanical clamp: TS

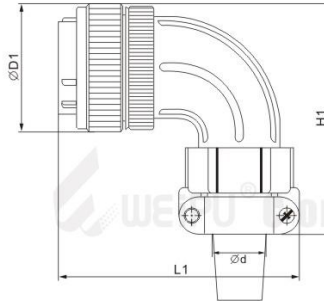

Dimension mm		WS20	WS24	WS28	WS32	WS40	WS48	WS55
ØD1	—	25.6	30	33.8	38.2	46.2	55.8	63
H1	—	53	57	61	66	78	91	100
L1	—	60	61	64	80	88	96	107
Ød Max	—	11.6	12.4	15.7	19.5	24	24	30

- Plug with angled back shell for plastic-hose: TC

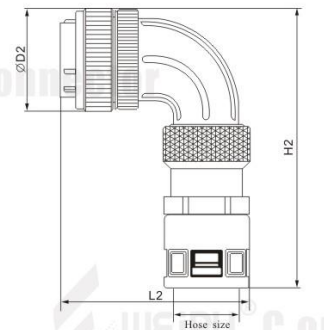

Dimension mm		WS20	WS24	WS28	WS32	WS40	WS48	WS55
ØD2	—	25.6	30	33.8	38.2	46.2	55.8	63
H2	—	60	62	65	82	88	96	107
L2	—	70	88	95	105	130	130	146
Adapter size	—	PG11	PG11	PG16	PG21	PG29	PG29	PG36
Hose size	—	3/8"	3/8"	1/2"	3/4"	1"	1"	1 1/4"

★ Solder contact arrangement and spec for WS, WF, WY series

WS16、WF16、WY16	2	3	4	5	7	9	10
Male contact face view							
Rated current (A)	10A	10A	5A	5A	5A	5A	5A
Contact diameter	∅1.5X2	∅1.5X3	∅1X4	∅1X5	∅1X7	∅1X9	∅1X10
Rated voltage (AC.V)	500V	500V	500V	500V	400V	400V	400V
Test voltage(AC.V) 1 min	1500V	1500V	1500V	1500V	1200V	1200V	1200V
Contact resistance mΩ	2.5	2.5	5	5	5	5	5
Insulation resistance MΩ	2000	2000	2000	2000	2000	2000	2000
Wire size mm ² /AWG	≤2/14	≤2/14	≤0.785/18	≤0.785/18	≤0.785/18	≤0.785/18	≤0.785/18

WS20、WF20、WY20	2	3	4	5	6	7	9	12
Male contact face view								
Rated current (A)	25A	25A	25A	10A	5A, 30A	10A	5A	5A
Contact diameter	∅2.5X2	∅2.5X3	∅2.5X4	∅1.5X5	∅1X4, ∅3X2	∅1.5X7	∅1X9	∅1X12
Rated voltage (AC.V)	500V	500V	500V	500V	500V	500V	500V	400V
Test voltage(AC.V) 1 min	1500V	1500V	1500V	1500V	1500V	1500V	1500V	1200V
Contact resistance mΩ	1	1	1	2.5	5, 1	2.5	5	5
Insulation resistance MΩ	2000	2000	2000	2000	2000	2000	2000	2000
Wire size mm ² /AWG	≤2.5/13	≤2.5/13	≤2.5/13	≤2/14	≤0.785/18 ≤4.17/11	≤2/14	≤0.785/18	≤0.785/18

WS24、WF24、WY24	2	3	4	9	10	12	19
Male contact face view							
Rated current (A)	25A	25A	25A	5A, 25A	10A	10A	5A
Contact diameter	∅2.5X2	∅2.5X3	∅2.5X4	∅1X5, ∅2.5X4	∅1.5X10	∅1.5X12	∅1X19
Rated voltage (AC.V)	500V	500V	500V	500V	500V	500V	500V
Test voltage(AC.V) 1 min	1500V	1500V	1500V	1500V	1500V	1500V	1500V
Contact resistance mΩ	1	1	1	5, 1	2.5	2.5	5
Insulation resistance MΩ	2000	2000	2000	2000	2000	2000	2000
Wire size mm ² /AWG	≤2.5/13	≤2.5/13	≤2.5/13	≤0.785/18 ≤2.5/13	≤2/14	≤2/14	≤0.785/18

WS28、WF28、WY28	2	3	4	7	12	16	17	20	24	26
Male contact face view										
Rated current (A)	25A	50A	25A	25A	10A	10A	10A	5A	5A	5A
Contact diameter	∅2.5X2	∅3.5X3	∅2.5X4	∅2.5X7	∅1.5X12	∅1.5X16	∅1.5X17	∅1X20	∅1X24	∅1X26
Rated voltage (AC.V)	500V	500V	500V	500V	500V	500V	500V	400V	400V	400V
Test voltage(AC.V) 1 min	2000V	1500V	1500V	1500V	1500V	1500V	1500V	1200V	1200V	1200V
Contact resistance mΩ	1	0.5	1	1	2.5	2.5	2.5	5	5	5
Insulation resistance MΩ	2000	2000	2000	2000	2000	2000	2000	2000	2000	2000
Wire size mm ² /AWG	≤2.5/13	≤6/9	≤2.5/13	≤2.5/13	≤2/14	≤2/14	≤2/14	≤0.785/18	≤0.785/18	≤0.785/18

★ Solder contact arrangement and spec for WS, WF, WY series

WS32、WF32、WY32	4	6	8	10	10B	11	12	13	19
Male contact face view									
Rated current (A)	50A	10A、25A	10A、50A	10A、25A	25A	25A	25A	10A、25A	10A
Contact diameter	∅ 3.5X4	∅ 1.5X2 ∅ 3.5X4	∅ 1.5X5 ∅ 3.5X3	∅ 1.5X5 ∅ 2.5X5	∅ 2.5X10	∅ 2.5X11	∅ 2.5X12	∅ 1.5X9 ∅ 2.5X4	∅ 1.5X19
Rated voltage (AC.V)	500V	500V	500V	500V	500V	500V	500V	500V	500V
Test voltage(AC.V) 1 min	1500V	1500V	1500V	1500V	1500V	1500V	1500V	1500V	1500V
Contact resistance mΩ	0.5	2.5、0.5	2.5、0.5	2.5、1	1	1	1	2.5、1	2.5
Insulation resistance MΩ	2000	2000	2000	2000	2000	2000	2000	2000	2000
Wire size mm ² /AWG	≤6/9	≤2/14 ≤2.5/13	≤2/14 ≤2.5/13	≤2/14 ≤2.5/13	≤2.5/13	≤2.5/13	≤2.5/13	≤2/14 ≤2.5/13	≤2/14

WS40、WF40、WY40	5	9	15	26	31
Male contact face view					
Rated current (A)	50A	25A、50A	10A	10A、25A	10A
Contact diameter	∅ 3.5X5	∅ 2.5X5 ∅ 3.5X4	∅ 1.5X15	∅ 1.5X22 ∅ 2.5X4	∅ 1.5X31
Rated voltage (AC.V)	500V	500V	500V	500V	500V
Test voltage(AC.V) 1 min	1500V	1500V	1500V	1500V	1500V
Contact resistance mΩ	0.5	1、0.5	2.5	2.5、1	2.5
Insulation resistance MΩ	2000	2000	2000	2000	2000
Wire size mm ² /AWG	≤6/9	≤2.5/13 ≤6/9	≤2/14	≤2/14 ≤2.5/13	≤2/14





WS48、WF48、WY48	5	7	20	27	38	42
Male contact face view						
Rated current (A)	100A	50A	25A	10A、25A	10A、25A	10A
Contact diameter	∅ 5.5X5	∅ 3.5X7	∅ 2.5X20	∅ 1.5X26 ∅ 2.5X1	∅ 1.5X33 ∅ 2.5X5	∅ 1.5X42
Rated voltage (AC.V)	500V	500V	500V	500V	500V	500V
Test voltage(AC.V) 1 min	1500V	1500V	1500V	1500V	1500V	1500V
Contact resistance mΩ	0.3	0.5	1	2.5、1	2.5、1	2.5
Insulation resistance MΩ	2000	2000	2000	2000	2000	2000
Wire size mm ² /AWG	≤16/5	≤6/9	≤2.5/13	≤2/14 ≤2.5/13	≤2/14 ≤2.5/13	≤2/14

WS55、WF55、WY55	4	7	40	53	61
Male contact face view					
Rated current (A)	50A、150A	50A、100A	10A、25A	10A、25A	10A
Contact diameter	∅ 3.5X1 ∅ 10X3	∅ 3.5X1 ∅ 5.5X6	∅ 1.5X25 ∅ 2.5X15	∅ 1.5X48 ∅ 2.5X5	∅ 1.5X61
Rated voltage (AC.V)	500V	500V	500V	500V	500V
Test voltage(AC.V) 1 min	1500V	1500V	1500V	1500V	1500V
Contact resistance mΩ	0.5、0.2	0.5、0.3	2.5、1	2.5、1	2.5
Insulation resistance MΩ	2000	2000	2000	2000	2000
Wire size mm ² /AWG	≤6/9 ≤35/2	≤6/9 ≤16/5	≤2/14 ≤2.5/13	≤2/14 ≤2.5/13	≤2/14

★ Crimp contact arrangement and spec for WS,WF,WY,WP,SP,SY series





WS16、WF16、WY16 SP17、SY17	2	3	4
Male contact face view			
Rated current (A)	10A	10A	5A
Contact diameter	∅ 1.5X2	∅ 1.5X3	∅ 1X4
Rated voltage (AC.V)	500V	500V	500V
Test voltage(AC.V) 1 min	1500V	1500V	1500V
Contact resistance mΩ	2.5	2.5	5
Insulation resistance mΩ	2000	2000	2000

WS20、WF20、WY20、WP20 SP21、SY21	2	3	5	7	8
Male contact face view					
Rated current (A)	25A	25A	10A	10A	5A
Contact diameter	∅ 2.5X2	∅ 2.5X3	∅ 1.5X5	∅ 1.5X7	∅ 1X8
Rated voltage (AC.V)	500V	500V	500V	500V	500V
Test voltage(AC.V) 1 min	1500V	1500V	1500V	1500V	1500V
Contact resistance mΩ	1	1	2.5	2.5	5
Insulation resistance mΩ	2000	2000	2000	2000	2000

WS24、WF24、WY24	4	5	9	12
Male contact face view				
Rated current (A)	25A	25A	10A	5A
Contact diameter	∅ 2.5X4	∅ 2.5X5	∅ 1.5X9	∅ 1X12
Rated voltage (AC.V)	500V	500V	500V	500V
Test voltage(AC.V) 1 min	1500V	1500V	1500V	1500V
Contact resistance mΩ	1	1	2.5	5
Insulation resistance mΩ	2000	2000	2000	2000

WS28、WF28、WY28	7	12	15	19
Male contact face view				
Rated current (A)	25A	10A	5A	5A
Contact diameter	∅ 2.5X7	∅ 1.5X12	∅ 1X15	∅ 1X19
Rated voltage (AC.V)	500V	500V	400V	400V
Test voltage(AC.V) 1 min	1500V	1500V	1200V	1200V
Contact resistance mΩ	1	2.5	5	5
Insulation resistance mΩ	2000	2000	2000	2000

★ Crimp contact arrangement and spec for WS,WF,WY series

WS32、WF32、WY32	4	6	10	15	19
Male contact face view					
Rated current (A)	50A	50A、10A	25A	10A	10A
Contact diameter	∅ 3.5X4	∅ 3.5X4 ∅ 1.5X2	∅ 2.5X10	∅ 1.5X15	∅ 1.5X19
Rated voltage (AC.V)	500V	500V	500V	500V	500V
Test voltage(AC.V) 1 min	1500V	1500V	1500V	1500V	1500V
Contact resistance mΩ	2.5	2.5	5	5	5
Insulation resistanceMΩ	2000	2000	2000	2000	2000

WS40、WF40、WY40	5	19	31
Male contact face view			
Rated current (A)	50A	25A	10A
Contact diameter	∅ 3.5X5	∅ 2.5X19	∅ 1.5X31
Rated voltage (AC.V)	500V	500V	500V
Test voltage(AC.V) 1 min	1500V	1500V	1500V
Contact resistance mΩ	1	1	2.5
Insulation resistanceMΩ	2000	2000	2000

WS48、WF48、WY48	31	42
Male contact face view		
Rated current (A)	25A	10A
Contact diameter	∅ 2.5X31	∅ 1.5X42
Rated voltage (AC.V)	500V	500V
Test voltage(AC.V) 1 min	1500V	1500V
Contact resistance mΩ	1	2.5
Insulation resistanceMΩ	2000	2000

WS55、WF55、WY55	38	61
Male contact face view		
Rated current (A)	25A	10A
Contact diameter	∅ 2.5X38	∅ 1.5X61
Rated voltage (AC.V)	500V	500V
Test voltage(AC.V) 1 min	1500V	1500V
Contact resistance mΩ	1	2.5
Insulation resistanceMΩ	2000	2000