

Star Grips • DIN 6336 light metal
24660.0663

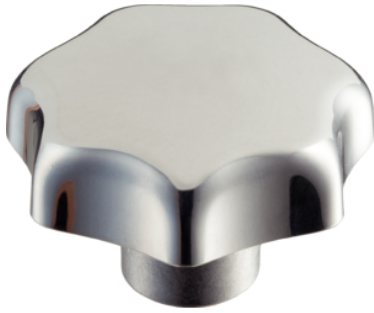

Product Description

These star grips are manufactured according to DIN 6336.

Material

Handle

- Light metal Al, polished

Drawing

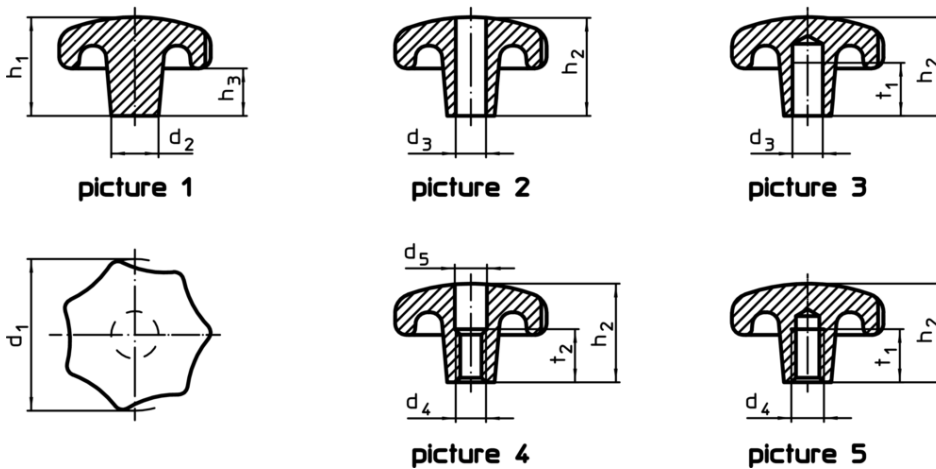

Order information

d ₁	d ₂	Dimensions			[g]	Art. No.
		d ₃ H7 [mm]	h ₂	t ₁ min.		
with smooth blind hole, form C – picture 3, polished						
63	20	12	40	22	116	24660.0663

Compliance

RoHS compliant

Contains lead - compliant according to exceptions 6a / 6b / 6c

Contains SVHC substances >0,1% w/w

Contains lead - SVHC list [REACH] as of 10.06.2022

Contains Proposition 65 substances



Lead can cause cancer and reproductive harm from exposure
<https://www.P65Warnings.ca.gov/>

Free from Conflict Minerals

This product does not contain any substances designated as "conflict minerals" such as tantalum, tin, gold or tungsten from the Democratic Republic of Congo or adjacent countries.