



Electromagnetic Pumps

ES - EM - ED - EL - ET - EK - EB



 **swiss made**

Our world is :
Quality, Efficiency, Flexibility
Our tools are :
100% control, Team work, Tuned in

HOW ELECTRO-MA

Pump description:

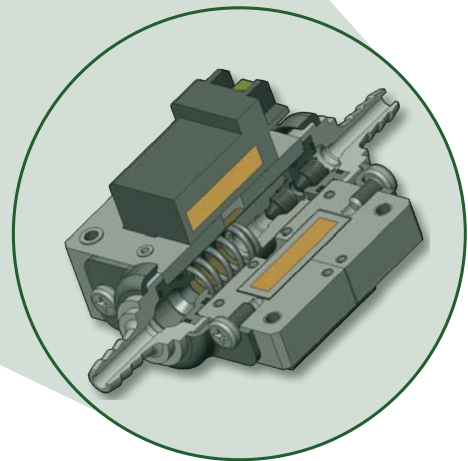
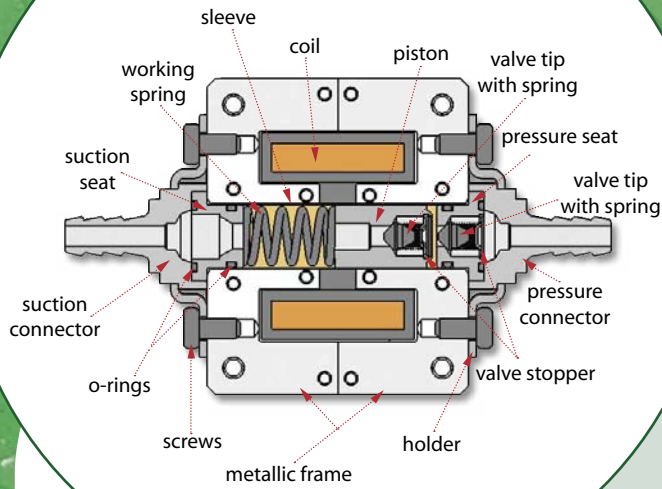

Connected to an AC power supply, the coil generates a strong magnetic field which will move the piston of the pump back & forth according to the frequency. This oscillation with the help of built-in valves, moves the air and liquid from inlet to outlet of the pump.

Function mode:

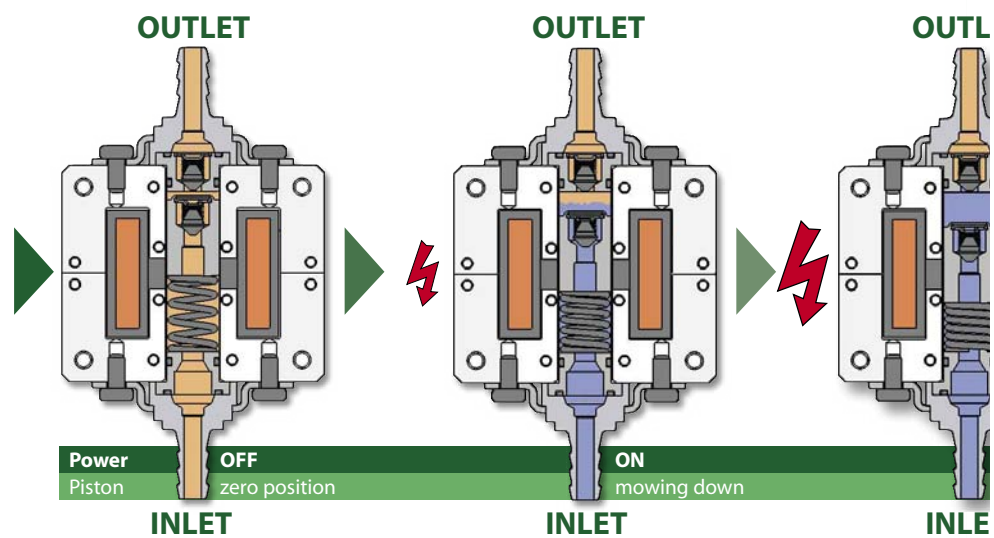

MAGNETIC PISTON PUMPS WORK

Electrical :

Standard voltages and frequencies are 230/50, 110/60, 100/50-60, 24/50-60, 12/50-60, special voltages on request. The pumps always need a rectified AC signal by a diode in line or a DC pulsed signal. Control of the performances of the pump by the frequency is possible.

Standard coils are in temperature class F (155°C) or class H (180°C) on request. The operating time can be continuous (100%ED) in general rated for ambient & liquid temperature about 50 °C.

Standard pumps are available with two or three AMP style 6.3 x 0.8mm tinned brass male tabs terminals but wires or other connections are also possible on request.

Insulation class is 1 with required grounding for high voltage or reinforced class on request.

Materials :

The material in contact are adapted to the liquid and to special functions. Brass, stainless steel and high-tech plastics are mainly used. Some pump designs have no O-ring or seal, for others a complete range of elastomers is available, included FEP coated O-rings.

Hydraulic connection :

Connection for soft hoses or threaded, there is a wide range of connectors in many different materials, types and sizes, please ask for further information.

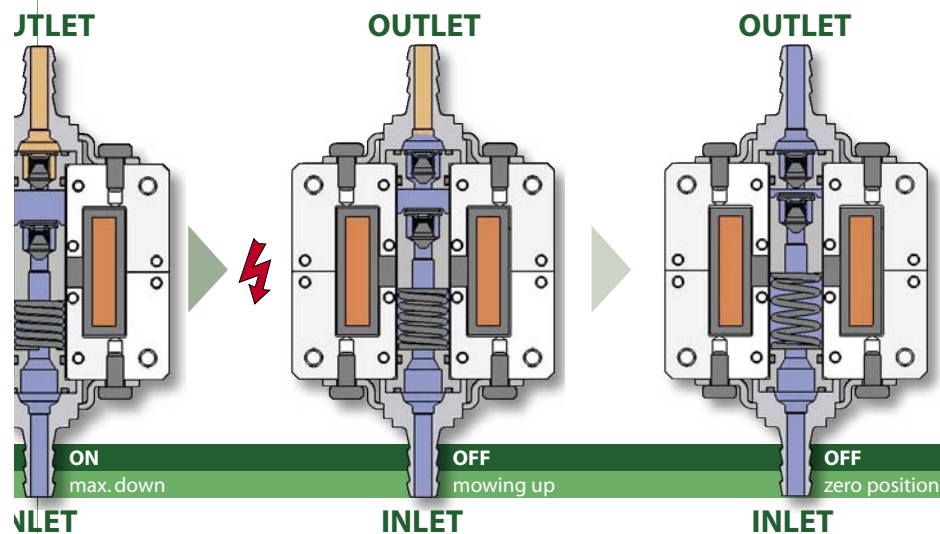

BENEFITS

Benefits:

- Small & compact
- Maintenance free
- 100% ED
- High pressure output
- Self-priming

- Light weight
- No shaft seal
- Long lifetime
- Self pressure limitation
- Non-return valves built-in

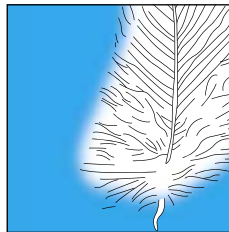

light

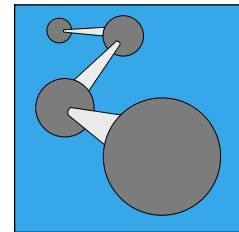

chemical resistance

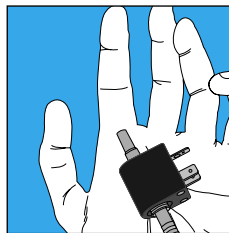

small

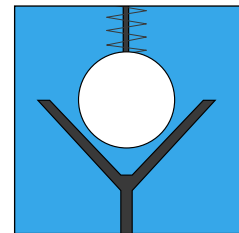

non return valve



powerful

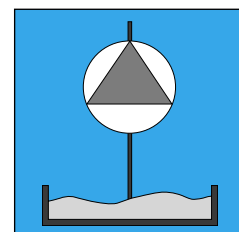

self-priming



long life-time

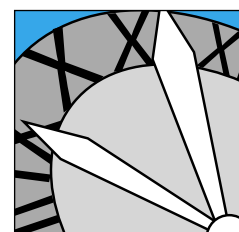

24/24 h

APPLICATIONS

Applications:

- Air, water & material treatment
- Printing systems
- Air conditioning & heating
- Laboratory & medical devices
- Domestic & industrial appliances
- Vending machines
- Household equipments
- Lubrication
- Automotive industry
- Circulation & temperature controle

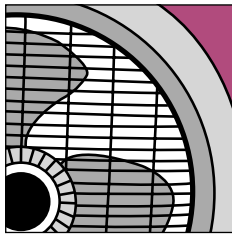

air conditioning

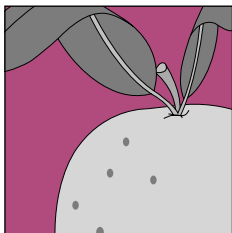

agriculture



dispensing & coffee systems

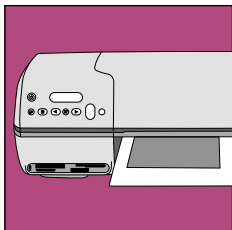

printers

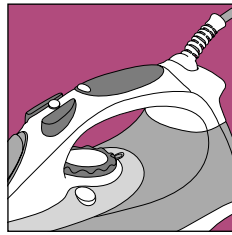

home appliances

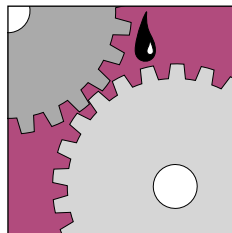

lubrication

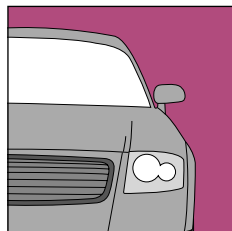

automotive

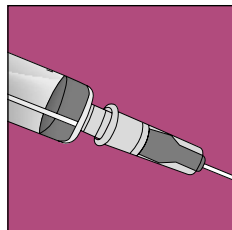

medical

DESCRIPTION CODE

Description code
Short explanation about the description code of the pumps

EMX 08-T/C-230/50

| | |
|------------|---|
| EM | Model of the pump / type of coil (ES-EM-ED-EL-ET-EK-EB) |
| X | Type of connectors (S-U-G-B...) |
| 08 | Model of pump, maximum pressure (08 = 0.8 bar) |
| T | Material of the seals & O-ring (P-E-V-TV...) |
| C | Material of the sleeve / Piston coating |
| 230 | Voltage (230-110-100-24-12...) |
| 50 | Frequency (50-60...) |

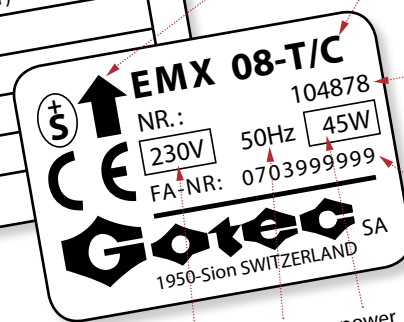

Our pumps

In the following pages you will only find a little extract of our pump production, but as privileged OEM we offer many options, functions and configurations to suit exactly your needs, so don't hesitate to ask for a speciality. For little quantity please ask for the list of standard pumps.

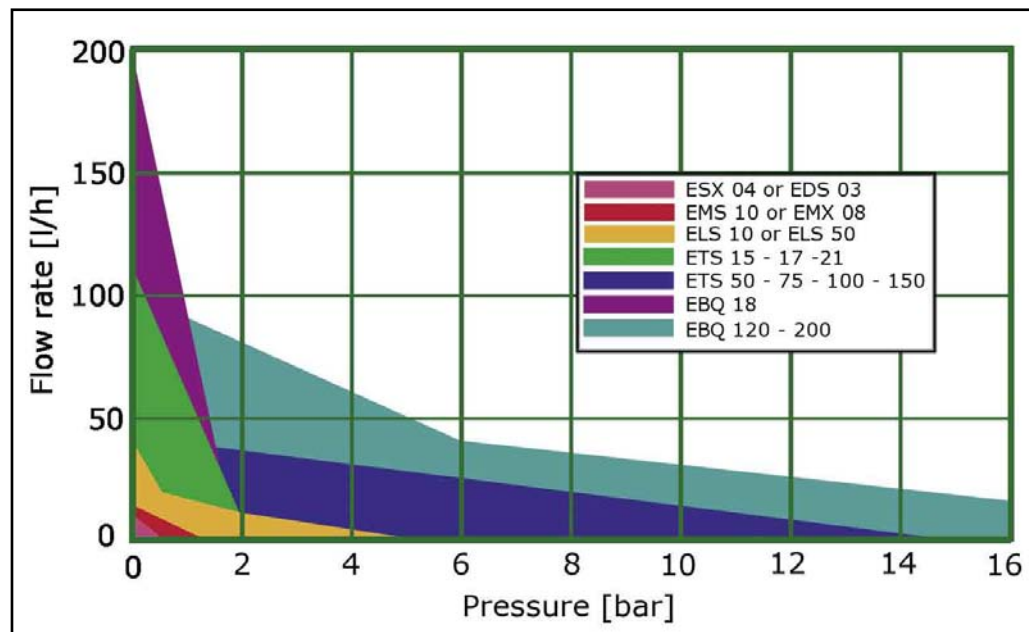

TECHNICAL DETAILS

ESX 04 Sub-Micropumps

The ESX 04 pump is simply the smallest electromagnetic pump on the market.

Low noise level, low power consumption but good performance. Small & light, silent & runs cool, the must for portable appliances and batteries powered applications. A small pump on which you can rely!

| | |
|-----------------------|------------------------------|
| Power consumption | 5 [W] |
| Weight | ~45 [g] |
| Suction height | 0.3 [m] |
| Dimensions | ~ 17/33/45 [mm] |
| Electrical connection | Three terminals 2.8/0.5 [mm] |
| Hydraulic connection | OD 7 [mm] for soft tubing |

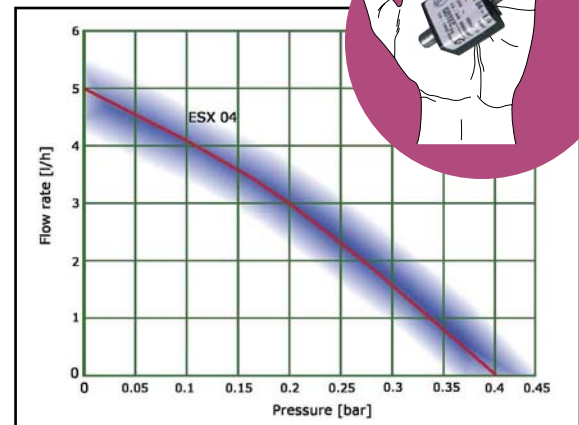

EDS 03 membrane pump

The EDS 03 is a new generation of diaphragm pump ideally suited for transfer different aggressive or light polluted liquid media at low pressures and flow rates. The pump is able to run dry and transfer air for circulation or sampling. No maintenance and long lifetime, give it a try! You won't be disappointed.

| | |
|-----------------------|---|
| Power consumption | 18 [W] |
| Weight | ~95 [g] |
| Suction height | 1.5 [m] |
| Dimensions | ~ 25/43/83 [mm] |
| Electrical connection | Three terminals 6.35/0.8 ISO/DIN 43650 [mm] |
| Hydraulic connection | OD 6 [mm] for soft tubing |

Accessories: Heat sink, DIN plug with diode

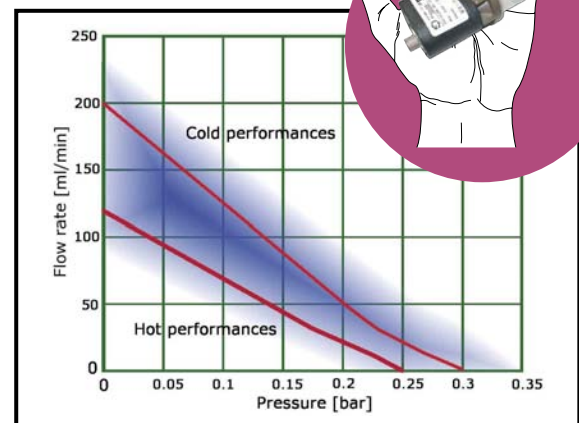

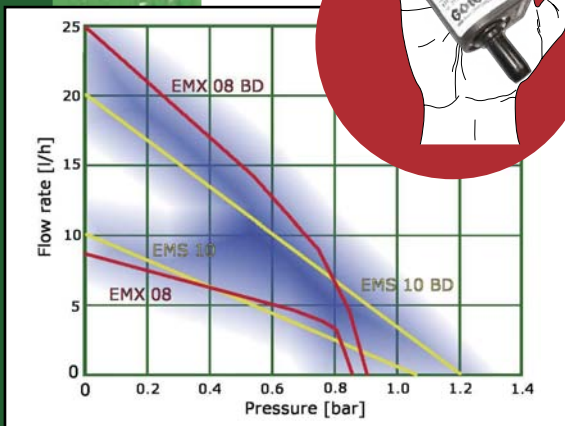
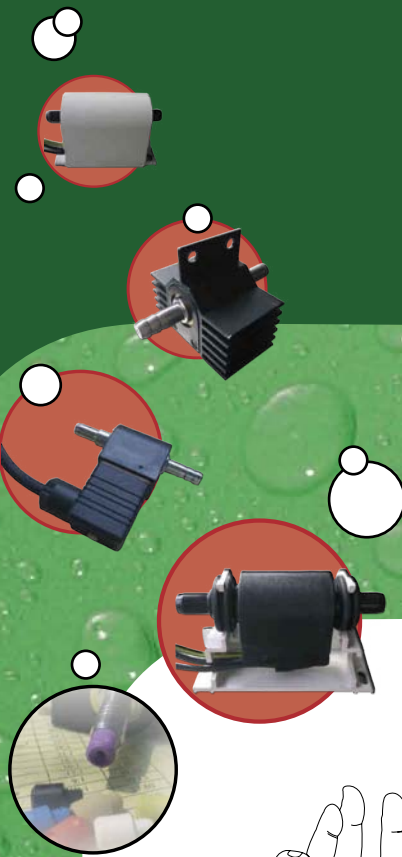

EMS 10 & EMX 08 Micropumps

The EMS and EMX are known worldwide, best seller for years they have solved many problems of draining water or light lubrication. The low cost EMS 10 has plastic body & connector where as the EMX 08 is made of stainless steel & PTFE for a wide range of fluids & applications.

| | |
|-----------------------|---|
| Power consumption | 18 [W] |
| Weight | ~95 [g] |
| Suction height | 0.5 to 3 [m] |
| Dimensions | ~ 23/43/76 [mm] |
| Electrical connection | Three terminals 6.35/0.8 ISO/DIN 43650 [mm] |
| Hydraulic connection | OD 8 [mm] for soft tubing or quick connectors |

Accessories: Mounting bracket, heat sink, DIN plug with diode, DEMA® metering tips.

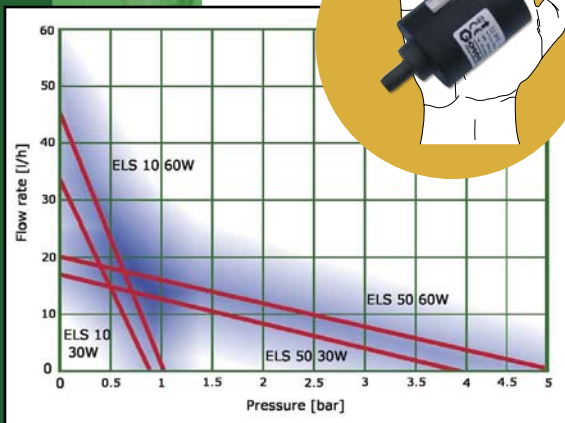
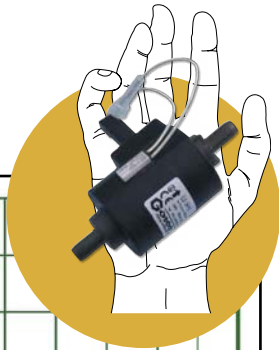

ELS 10 & ELS 50 mini pumps

The challengers EL, new designed to be successful and universal! The ultrasonic welded «one shot» construction simply eliminates the elastomer O-rings, so no further need to adapt expensive seals to suit more aggressive fluids. As the piston is sliding in a plastic jacket, the chance of the piston sticking by dried liquid (soap, syrup...) or to be corroded is greatly reduced. Extremely silent, the pump can be now integrate in appliances, where in the past, electromagnetic pumps were not accepted because they are too noisy. Available with two types, 10 & 50, with a combination of different coils & power, you should find your exact requested performances.

| | |
|-----------------------|---|
| Power consumption | 30, 45 or 60 [W] available with different coils |
| Weight | ~300 [g] |
| Suction height | 0.5 to 2 [m] |
| Dimensions | ~ 37.5/56.5/96 [mm] |
| Electrical connection | Three terminals 6.35/0.8 ISO/DIN 43650A[mm] |
| Hydraulic connection | OD 8 [mm] for soft tubing or quick connectors |

Accessories: Mounting bracket

ET pumps, the absolute reference

ETS 15, 17, 21 Delivery pumps

Looking for a reliable pump, compact with good flow output? Then the ETS types 15, 21, 17 should be your choice. They fit in many different applications. A range of wetted materials are available making the pumps suitable for many fluid transfer applications and with great options of adaptation to your system. Delivered on the standard models with ETS connectors for soft tubing, other connectors on request. The choice of every major OEM in household appliances and vending machines.

| | |
|-----------------------|---|
| Power consumption | 25, 40, 45 [W] |
| Weight | ~500 [g] |
| Suction height | 1 to 3 [m] |
| Dimensions | ~ 50/60/105 [mm] |
| Electrical connection | Two terminals 6.35/0.8, earth on the metallic frame |
| Hydraulic connection | ETS with OD 7.5 & 9.5 [mm] for soft tubing, other connection on request |

ETG + ETS 50, 75, 100, 150 Pressure pumps

Power unleashed! Could you believe that a such tiny pump can reach up to 15 [bar]? At least one of our type ET & EK 50,75,100,150 must meet your pressure performances. If it is not the case just couple the pumps in series. Delivered on the standard models with ETS connectors for soft tubing or ETG with G 1/8" thread, other connectors on request. High-tech systems love them and you will recognize this sound in every serious espresso machine.

| | |
|-----------------------|--|
| Power consumption | 45 [W] |
| Weight | ~700 [g] |
| Suction height | 0.5 to 2 [m] |
| Dimensions | ~ 50/60/140 [mm] |
| Electrical connection | Two terminals 6.35/0.8, earth on the metallic frame |
| Hydraulic connection | ETS with OD 7.5 [mm] for soft tubing, or ETG with internal thread G1/8", other connection on request |

Options: Round & lighter coil with wire electrical connection (EK. series)

Accessories: Mounting brackets, diodes, cables with diode included, electronic drivers for DC power supply, frequency variable control, filter, thermo switch

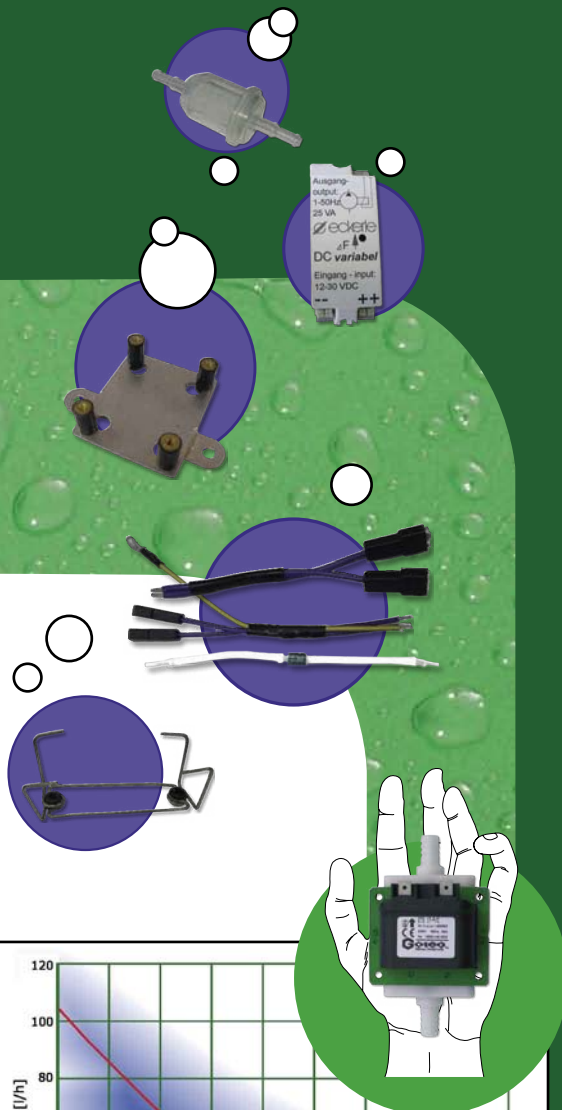
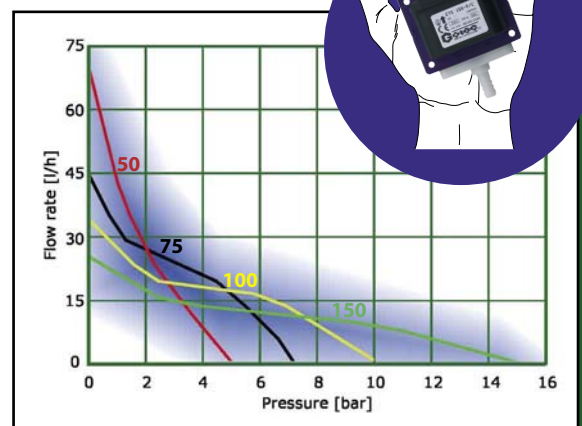
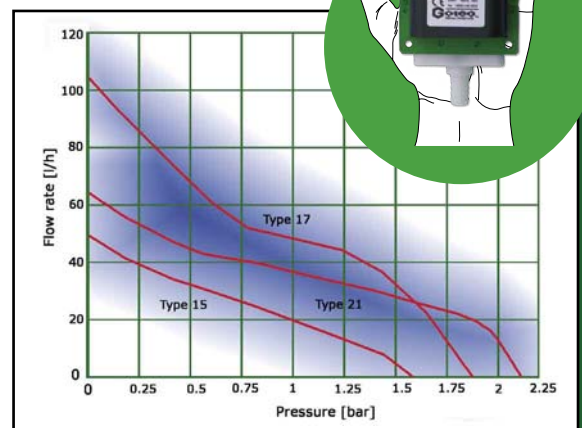



EBV 18, EBQ 18, EBQ 35, the maximum pumps

You dreamed about a compact pump exiting a large flow against reasonable counter pressure up to 3 [bar]? It comes true! the EB 18 & EB 35 are now real! Compatible with many different liquids, the application range is large. The pump has the diode and varistor included, just PLUG & PLAY.

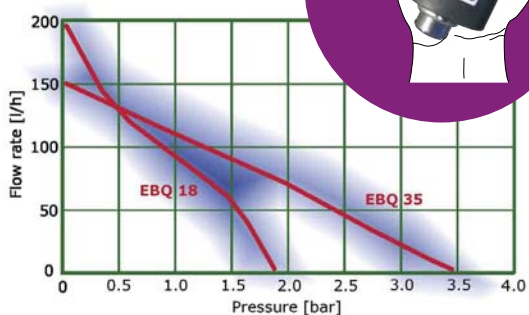

| | |
|-----------------------|--|
| Power consumption | 120 [W] |
| Weight | ~1200 [g] |
| Suction height | 0.5 [m] |
| Dimensions | ~ 60/80/130 [mm] |
| Electrical connection | Three terminals 6.35/0.8 ISO/DIN 43650A [mm] |
| Hydraulic connection | Internal thread G 3/8" |



EBQ 120, EBQ 200

A condensate of power, the EBQ 120 or EBQ 200 will push you up in the high pressure lands and open the door to applications where electromagnetic pumps were not invited. Be first to take full advantage of the new products ! With a maximum pressure higher than 20 [bar], you can easily double it by mounting two pumps in serie.

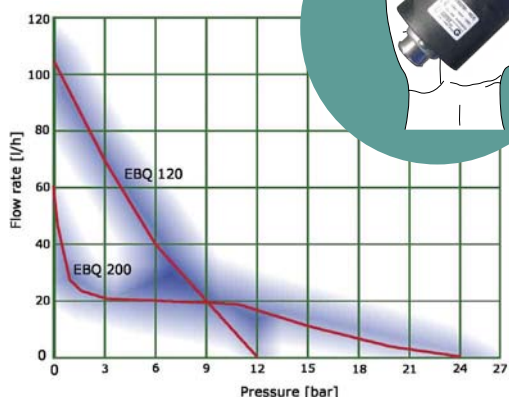

| | |
|-----------------------|--|
| Power consumption | 120 [W] |
| Weight | ~1200 [g] |
| Suction height | 0.5 [m] |
| Dimensions | ~ 60/80/130 [mm] |
| Electrical connection | Three terminals 6.35/0.8 ISO/DIN 43650A [mm] |
| Hydraulic connection | Internal thread G 3/8" |

BOX «FP» FOR ET, EK & EL pumps:

Safe, elegant and discreet, the new box FP will fit with the pump models:

ET : ETS, ETSM, ETU, ETG, ETB, ETNP, ET, ETN, ETX

EK : EKS, EKSM, EKU, EKG, EKB, EKNP, EK, EKN, EKX

EL : ELS 10, ELS 50

And for types 10, 15, 17, 21, 50, 75, 50, 100, 150,

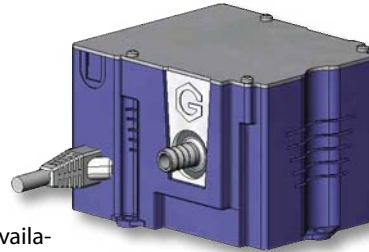

This box has a special location for an electronic circuit board, the box is available with three configurations in standard:

1. Box FP with cover, empty.
2. Box FP with cover and a simple electronic, containing diode, fuse and power cord.
3. Box FP with cover and electronic, containing diode, thermo-switch and power cord with two NO / NC alarm signal wires and on the other side a RJ45 connector with two signal entry: one ON/OFF for switching ON and OFF the pump and a second for any alarm.

Test procedure on GOTEC pumps:

The final assembly of the pump is done on ultra modern automatic test benches.



- Each pump is fully tested under GOTEC or customer's criteria.
- Second electric high ppt test
- Verification of the direction / first tightness of the pump
- Valves proper function
- Self priming
- Water performance as open flow rate, flow rate against pressure, and maximal pressure
- Control of the electric consumption

All these values are stored and printed, copies are at the disposition of the customer on request. If all these tests are positive the pump received a label (see page 500 with different information and an identification number for follow up).

OF: 911270/006/000 Date: 02-01-2000

| No série | Uiso [mA] | Elec [mbar] | Tenu [m] | Qmax [mbar] | Qtra [l/h] | Pmax [bar] | Tenu 2000 [mbar] | Imax 0200 [mA] |
|------------|-----------|-------------|----------|-------------|------------|------------|------------------|----------------|
| 0002002125 | 0.80 | 0.06 | 2.04 | 0015 | 088.9 | 32.4 | 5.80 | 1032 |
| 0002002126 | 0.82 | 0.09 | 4.77 | 0005 | 087.0 | 27.0 | 5.77 | 0162 |
| 0002002127 | 0.81 | 0.44 | 2.9 | 0000 | 088.6 | 31.9 | 6.30 | 1208 |
| 0002002128 | 0.82 | 0.44 | 4.4 | 0001 | 090.7 | 32.9 | 5.42 | 0984 |
| 0002002129 | 0.83 | 0.70 | 4.4 | 0000 | 089.7 | 27.0 | 5.74 | 0561 |
| 0002002130 | 0.83 | 0.13 | 2.2 | 0000 | 086.7 | 27.3 | 5.49 | 1028 |
| 0002002131 | 0.82 | 0.14 | 2.2 | 0002 | 090.0 | 25.2 | 5.68 | 1248 |
| 0002002132 | 0.82 | 0.14 | 2.2 | 0000 | 090.0 | 33.5 | 5.71 | 1620 |
| 0002002133 | 0.81 | 0.40 | 4.4 | 0000 | 089.9 | 29.9 | 5.33 | 1202 |
| 0002002134 | 0.82 | 0.20 | 4.4 | 0001 | 089.8 | 28.2 | 5.49 | 1054 |
| 0002002135 | 0.82 | 0.20 | 4.4 | 0000 | 087.2 | 25.1 | 5.97 | 0743 |
| 0002002136 | 0.81 | 0.19 | 2.2 | 0004 | 089.8 | 31.6 | 5.49 | 0606 |
| 0002002137 | 0.82 | 0.07 | 2.2 | 0000 | 089.8 | 27.8 | 5.45 | 0992 |
| 0002002138 | 0.82 | 0.44 | 4.4 | 0000 | 087.4 | 25.6 | 5.76 | 0778 |
| 0002002139 | 0.82 | 0.44 | 4.4 | 0005 | 087.0 | 27.0 | 5.64 | 1263 |
| 0002002140 | 0.81 | 0.44 | 4.4 | 0000 | 088.6 | 31.9 | 5.65 | 1107 |
| 0002002141 | 0.81 | 0.08 | 2.2 | 0000 | 086.0 | 29.4 | 5.58 | 0932 |
| 0002002142 | 0.80 | 0.08 | 2.2 | 0000 | 086.0 | 31.5 | 5.28 | 1035 |
| 0002002143 | 0.82 | 0.08 | 2.2 | 0000 | 092.4 | 29.1 | 5.54 | 0843 |
| 0002002144 | 0.82 | 0.12 | 2.2 | 0000 | 091.5 | 25.9 | 5.89 | 1160 |
| 0002002145 | 0.81 | 0.17 | 2.2 | 0000 | 084.2 | 30.7 | 5.68 | 0310 |
| 0002002146 | 0.79 | 0.26 | 2.2 | 0000 | 088.8 | 30.6 | 5.42 | 1178 |
| 0002002147 | 0.81 | 0.21 | 2.2 | 0007 | 082.7 | 29.2 | 5.25 | 0142 |



Factory equipment:





Up-to-date production machines, last generation tools, efficient robotic and special designed machines, produce & control in a constant quality the different pump parts.



Warranty:

A one year warranty is generally given under detailed conditions. Lifetime of the pumps vary strongly in function of the internal configuration and external conditions, but in a range from 500 to 20'000 hours at 50 Hz.

Approval:

| | |
|---|--|
|  | <p>The company is ISO 9001 since 1997. Quality is not negotiable and part of every process in the factory.</p> |
|  | <p>All our products are CE compliant with min. 72/23 CEE (security) & 89/336 CEE (emc).</p> |
|  | <p>The pumps are ROHS & WEEE conform.</p> |
|  | <p>UL & CSA recognition or listing available on certain pumps in categories REUZ2 & 8, MERG2 & 8, SORT2 & 8.</p> |

Please contact US:

Should you need any further information, please feel free to contact us:

Gotec SA | Rue des Casernes 59 | CH-1950 SION | Switzerland
 Tel. +41 27 205 7 205 | Fax +41 27 205 7 206
www.gotecpumps.com | www.gotec.ch | info@gotec.ch

