

**Product Information**

**HD1K-008..025GM / K**

**Flow Switch  
 HD1K**



- High switching power
- Compact design

**Characteristics**

Mechanical flow switch, for fluid or gaseous media, with spring-supported piston and magnetic triggering of a reed switch. Robust construction in brass or stainless steel.

**Technical data**

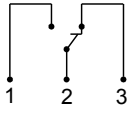
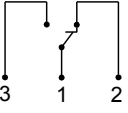
<b>Switch</b>	reed switch	
<b>Nominal width</b>	DN 8..25	
<b>Process connection</b>	female thread G 1/4..G 1 (further process connections available on request)	
<b>Switching range</b>	0.1..80 l/min	for details see table "Ranges"
<b>Pressure loss</b>	0.4..1.6 bar at Q <sub>max.</sub>	
<b>Q<sub>max.</sub></b>	to 100 l/min	
<b>Tolerance</b>	±5 % of full scale value	
<b>Pressure resistance</b>	PN 200 bar optionally PN 500 bar	
<b>Media temperature</b>	-20..+120 °C with display Z -20..+70 °C optionally -20..+150 °C	
<b>Ambient temperature</b>	-20..+70 °C	
<b>Media</b>	water, oil (gases and aggressive media available on request)	
<b>Wiring</b>	changeover No. 0.213  optionally changeover No. 0.282  optionally red or red / green diode in the DIN 43650-A plug	
<b>Switching voltage</b>	max. 250 V AC	
<b>Switching current</b>	max. 1.5 A	
<b>Switching capacity</b>	max. 50 VA	
<b>Protection class</b>	2 - Safety insulation	
<b>Ingress protection</b>	IP 65	

<b>Electrical connection</b>	plug DIN 43650-A / ISO 4400 Optionally for round plug connector M12x1, 4-pole	
<b>Materials medium-contact</b>	<i>Brass construction:</i> CW614N nickelled, CW614N, 1.4310, hard ferrite, NBR	<i>Stainless steel construction:</i> 1.4571, 1.4404, 1.4310, hard ferrite PTFE-coated, FKM
<b>Non-medium-contact materials</b>	PA, CW614N, NBR	
<b>Weight</b>	see table "Dimensions and weights"	
<b>Installation location</b>	Standard: horizontal inwards flow from the left; other installation positions are possible; the installation position affects the switching point and range.	

**Ranges**

For switching ranges, the details in the table correspond to horizontal inwards flow and decreasing flow rate; for display ranges they correspond to horizontal inwards flow and increasing flow rate.

**Standard type HD1K**

Switching range l/min H <sub>2</sub> O	Optionally Display range l/min H <sub>2</sub> O	Q <sub>max.</sub> recommended	Pressure loss bar at Q <sub>max.</sub> H <sub>2</sub> O
0.1 - 1.0	0.1 - 1.2	6	0.4
0.5 - 5.0	0.5 - 6.0	10	0.5
1.0 - 10.0	1.0 - 12.0	20	0.6
2.0 - 20.0	2.0 - 23.0	30	0.4
3.0 - 30.0	3.0 - 34.0	40	
4.0 - 40.0	4.0 - 45.0	60	0.8
6.0 - 60.0	6.0 - 65.0	80	1.4
20.0 - 80.0	20.0 - 85.0	100	1.6

Special ranges are available.

**Product Information**

**HD1K-008..025GM / K**

**Dimensions and weights**

	G	Types	SW	X	Weight kg
<b>Brass</b>	G 1/4	HD.K-008GM	40	15	1.4
	G 3/8	HD.K-010GM			
	G 1/2	HD.K-015GM		18	1.3
	G 3/4	HD.K-020GM			
	G 1	HD.K-025GM			
<b>Stainless steel</b>	G 1/4	HD.K-008GK	41	15	1.3
	G 3/8	HD.K-010GK			
	G 1/2	HD.K-015GK		18	1.2
	G 3/4	HD.K-020GK			
	G 1	HD.K-025GK			

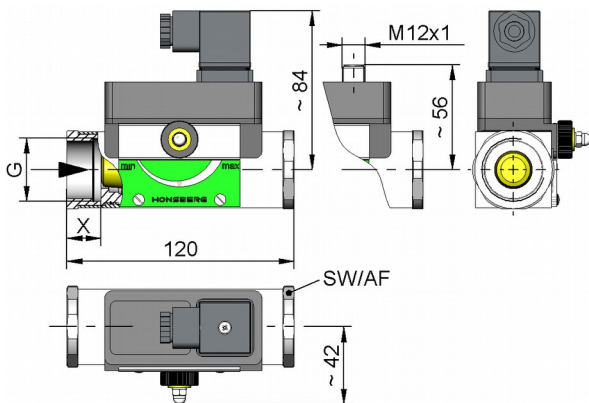

**additional weights for options**

additional switching head 0.10 kg    Display O / Z 0.10 kg  
 Display O1 / Z1 0.05 kg

**Handling and operation**

**Note**

- Include straight calming section of 5 x DN in inlet and outlet
- If the media are dirty, install a filter (use magnetic filter for ferritic components).
- It must be ensured that the values given for voltage, current, and power are not exceeded.
- When switch on, a load must be connected in series.
- The electrical details apply to ohmic loads. Capacitive, inductive and lamp loads must be operated using a protective circuit.

**Adjustment**

If it is necessary to set the switching value, the switching head can be adjusted by adjustment of a pinion. When the switching value is reached, the switching unit is fixed in place by a fastening bolt (SW 8).



**Ordering code**

HD 1. 2. 3. 4. 5. 6. 7.  
   **G**

<b>1. Construction</b>		
1K	standard	
<b>2. Display options</b>		
-	no mechanical display	
O1-	with measurement display at side O1	
O-	with measurement display at side O	
Z1-	with frontal measurement display Z1	
Z-	with frontal measurement display Z	
<b>3. Nominal width</b>		
008	DN 8 - G 1/4	
010	DN 10 - G 3/8	
015	DN 15 - G 1/2	
020	DN 20 - G 3/4	
025	DN 25 - G 1	
<b>4. Process connection</b>		
G	female thread	
<b>5. Connection material</b>		
M	brass	
K	stainless steel	
<b>6. HD1K - switching range H<sub>2</sub>O for horizontal inwards flow</b>		
001	0.1 - 1 l/min	●
005	0.5 - 5 l/min	●
010	1.0 - 10 l/min	●
020	2.0 - 20 l/min	●
030	3.0 - 30 l/min	●
040	4.0 - 40 l/min	●
060	6.0 - 60 l/min	●
080	20.0 - 80 l/min	●
<b>7. Special switching head</b>		
A	switching head ATEX A-H1.1 / A-H2.1 Please order the switching head for  -use in addition.	

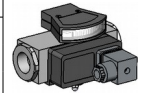

HD.KO1-

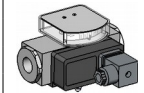

HD.KO-



HD.KZ1-

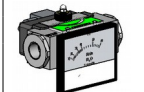

HD.KZ-

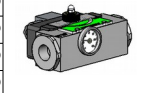

Temperature-display



**Options**

- Signal lamp red or red / green in the plug DIN 43650-A
- Rhodium contact (250 VAC, 0,5 A, 30 VA)
- Temperature resistant up to 150 °C
- Reinforced piston (only if made of brass)
- Additional switching head
- Connection for round plug connector M12x1
- High pressure model PN 500 (only if made of brass)
- Adjustment scale with markings in l/min
- Temperature monitoring
- Damping for gas monitoring (only for standard version)
- Switching values for oil or gas
- Special values
- Temperature display 0..120 °C
- Switching head made of metal

**Ordering information**

- Specify direction of flow, medium, and switching range.
- For viscous media specify viscosity, temperature, and medium (e.g. ISO VG 68) (enquire about switching range).
- For gases, state pressure (relative or absolute), temperature and medium (e.g. air) (request switching range).