

oerlikon
leybold vacuum

TURBOVAC T 1600, T 1601, TW 1600

Turbomolecular pump
with integrated frequency converter

Incorporation Declaration & Operating Instructions
17200039_002_A1

Part Nos.

800040Vxxxx

800041Vxxxx



Contents

	Page
0 Important Safety Information	5
0.1 Mechanical hazards	5
0.2 Electrical hazards	6
0.3 Thermal hazards	7
0.4 Hazards caused by materials and substances	7
0.5 Danger of ignition	8
0.6 Dangers in connection with safety-related measures and precautions	8
0.7 Risk of damaging the pump	8
1 Description	10
1.1 Standard equipment	10
1.2 Technical data	11
1.3 Ordering data	12
2 Transport and storing	15
3 Installation	16
3.1 Conforming utilization	16
3.1.1 Non-conforming utilization	16
3.2 Operating environment	17
3.3 Attach the pump to the vacuum chamber	18
3.4 Forevacuum connection	22
3.5 Connect the cooling	23
3.6 Connect the purge gas and venting valve	23
3.7 Electrical connection	25

Contents

4	Operation	27
4.1	Media compatibility / purge gas	27
4.2	Start-up	27
4.3	Interfaces	28
4.3.1	Control connector X1	28
4.3.2	RS 232 service interface	33
4.3.3	Profibus DP	34
4.4	Switching on	49
4.5	Shutting down	50
4.6	Venting	50
4.7	Bakeout	51
4.8	Removing the pump from the system	52
5	Maintenance	53
5.1	Cleaning	53
5.2	Oerlikon Leybold Vacuum service	54
6	Troubleshooting	55
7	Waste disposal	57
	EC Incorporation Declaration	59
	EC Declaration of Conformity	60
	Index	63

Safety Information

NOTICE



Obligation to Provide Information

Before installing and commissioning the TURBOVAC, carefully read these Operating Instructions and follow the information so as to ensure optimum and safe working right from the start.

The Oerlikon Leybold Vacuum **TURBOVAC** has been designed for safe and efficient operation when used properly and in accordance with these Operating Instructions. It is the responsibility of the user to carefully read and strictly observe all safety precautions described in this section and throughout the Operating Instructions. The pump **must only be operated in the proper condition and under the conditions described in the Operating Instructions**. It must be operated and maintained by trained personnel only. Consult local, state, and national agencies regarding specific requirements and regulations. Address any further safety, operation and/or maintenance questions to our nearest office.

DANGER



DANGER indicates an imminently hazardous situation which, if not avoided, will result in death or serious injury.

WARNING



WARNING indicates a potentially hazardous situation which, if not avoided, could result in death or serious injury.

CAUTION



CAUTION indicates a potentially hazardous situation which, if not avoided, could result in minor or moderate injury.

NOTICE



NOTICE is used to notify users of installation, operation, programming or maintenance information that is important, but not hazard related.

We reserve the right to alter the design or any data given in these Operating Instructions. The illustrations are not binding.

Retain the Operating Instructions for further use.

0 Important Safety Information

0.1 Mechanical hazards

- 1 Avoid exposing any part of the human body to the vacuum.
- 2 The pressure in the pump must not exceed 1.4 bar (absolute).
- 3 The pump is intended for generating a vacuum only. If there is a risk of an overpressure within the system and the pump, then the pump must be protected against this, by way of an overpressure safety valve, for example.
- 4 Vent the pump only up to atmospheric pressure.
- 5 When using the pump with a purge gas valve, protect the purge gas supply such that in the event of a malfunction no overpressure can occur within the system.
- 6 The pump must be firmly mounted to the vacuum chamber. If the mounting is not sturdy enough, pump blockage could cause the pump to break loose; internal pump components could be thrown in all directions. Never operate the pump (in bench testing, for example) without proper flanging to the vacuum chamber. Observe the information in Section 3.3.
- 7 We recommend to change the rotor after **80,000 hours of operation** or after **20,000 starts/ stops** or cycles at the latest. Due to high-speed and temperature, the service life of the rotor is limited. If the rotor is changed too late, it may be destroyed. Thus in the flange mounts high forces and torque conditions can occur. The mounting screws for the pump may be torn off. When using clamped flange connections at the housing or with components above the housing, sudden twisting of the entire pump can be experienced.
- 8 Turbopumps as described in the following operation manual contain a high portion of kinetic energy due to their high rotational speed in combination with the specific rotor mass. In case of a malfunction of the system, for example rotor/stator contact or even a rotor crash, the rotational energy is released.
- 9 To avoid the destruction of the equipment and to prevent injuries of the operating staff the leading European manufacturers of vacuum pumps strictly recommend to follow the installation instructions as given in this manual.

WARNING



Safety Information

WARNING

0.2 Electrical hazards

- 1 The electrical connections must only be provided by a trained electrician as specified, for example, by the regulations EN 50110-1. Observe local regulations.
 - 2 The frequency converter must be protected by a suitable mains power isolating facility or a mains switch.
 - 3 Lethal voltages are present at the mains connections. Before starting with any maintenance and service work, de-energise (lockout/tagout) the product first.
 - 4 In order to prevent in the event of a malfunction contact with dangerously high voltages, the pump must be connected to protective ground.
 - 5 Unplug any connectors only when the mains voltage is switched off and the pump does no longer turn.
 - 6 Unauthorized device conversion and modifications are prohibited for safety reasons.
 - 7 Hazardous voltages are present within the frequency converter. When coming into contact with these, death or severe injury can result. After the pump has arrived at standstill, disconnect the frequency converter from the mains power and prevent it against being switched on inadvertently (lockout/tagout) before opening it. Basically there is no reason why the frequency converter should be opened. There are no user serviceable parts inside.
 - 8 Lay connecting lines so that they cannot be damaged. Protect the lines against humidity and contact with water. Avoid any heat stress on the line due to unfavourable laying conditions.
 - 9 Suitably support the connecting lines so that the pumps are not exposed to any major mechanical stress.
 - 10 Do not expose pump, frequency converter and the connections to dripping water. Note the information on the IP type of protection.
 - 11 When storing pump, frequency converter and connecting lines in a humid atmosphere, these can suffer corrosion. Corrosion gives rise to conductive deposits which in turn can cause short-circuits and reduce the insulation levels of electrical components
 - 12 Transport pump, frequency converter and connecting cables only in their original packaging so as to avoid any mechanical damage which in turn may reduce air gaps and creepage distances.
 - 13 When applying external voltages above 42 V to the connection terminals, observe the applicable VDE safety regulations!
 - 14 Make the electrical connections only after pump and accessories (e.g. air cooler) have been installed mechanically.
-

0.3 Thermal hazards

- 1 Handle the equipment only while vented and cooled down.
- 2 During operation of the pump certain areas can get so hot (80 °C max.) so that there is the risk of suffering burns. Protect hot parts against being touched.
- 3 Note the warning information on the housing surface. If these warning notices have been removed, covered or obstructed, include corresponding additional warning notices.

CAUTION



0.4 Hazards caused by materials and substances

- 1 The pump is not suited for pumping of reactive or corrosive media. If the rotor is attacked by process gases, it can suffer destruction. Thus in the flange mounts high forces and torque conditions can occur. The mounting screws for the pump may be torn off. When using clamped flange connections at the housing or with components above the housing, sudden twisting of the entire pump can be experienced.
- 2 When pumping dusty media, use a dust filter.
- 3 If low concentration corrosive or reactive gases are being pumped, then operate the pump with purge gas.
- 4 Some media (such as aluminum trichloride) can sublime inside the pump and form deposits. Thick deposits reduce the play between moving parts to the point that the pump could seize. In some processes deposits can be prevented by heating the pump. Please consult us in case such problems arise.
- 5 Please consult us as to which types of pump are required for specific processes and applications.
- 6 The forevacuum line must be tight. Hazardous gases can escape at leaks or the gases being pumped can react with air or humidity. A leak search will always be required after having installed the pump and after service work on the vacuum. Upon delivery the pump has an integral leak rate of $< 5 \cdot 10^{-7}$ mbar-l/s. When pumping toxic gases we recommend a leak search on a regular basis.
- 7 If the pump has previously handled hazardous gases, implement the proper precautionary measures before opening the intake or exhaust connection. Before opening the pump, purge it for a longer period of time with an inert gas. If necessary, use gloves, a respirator and/or protective clothing and work under an exhaust hood. Firmly seal off the pump. When shipping the contaminated pump for servicing, please also state the type of hazard. For this you must use a form which we have prepared for you.

DANGER



Safety Information

- 8 Contaminated parts can be detrimental to health and environment. Before beginning with any work, first find out whether any parts are contaminated. Adhere to the relevant regulations and take the necessary precautions when handling contaminated parts.

CAUTION



0.5 Danger of ignition

- 1 During operation the pressure inside the turbomolecular pump is so low that there is no danger of ignition (at pressures below about 100 mbar). A hazardous condition will be created if flammable mixtures enter the hot pump at pressures above 100 mbar. During operation the pump can reach temperatures as high as 120°C internally, and at parts of the outside surfaces 80 °C. Sparks could occur in case of damage to the pump and these could ignite explosive mixtures. Also note the safety information provided by the gas supplier.

CAUTION



0.6 Dangers in connection with safety-related measures and precautions

- 1 The frequency converter is not equipped with its own emergency shut down switch. Such a facility needs to be provided from the side of the system.

NOTICE



0.7 Risk of damaging the pump

- 1 Never touch the rotor. Touching the rotor may cause injury and damage the rotor bearing.
- 2 Foreign objects which enter the pump through the intake would cause serious damage to the rotor. That's why we recommend installing an inlet screen. Damages caused during operation without the inlet screen are excluded from warranty.
- 3 The contact surfaces of pump housing, vacuum system and centering ring must be free of grease and dry so as to ensure sufficient stability in case the rotor seizes.
- 4 The interface connectors have UNC 4-40 threads. Do not use connectors with M3 threads.
- 5 Disconnect and connect the cable connections only while the pump is turning no longer (green status LED off) **and** with the mains power switched off (power LED off). Otherwise there is the risk of damaging the frequency converter.
- 6 Exposure of the pump to accelerating forces must be avoided or reduced to such an extent that the rotor unit will not be excited by vibrations. In the case of critical applications you must consult our Applications Dept. first.
- 7 The frequency converter contains electrostatically sensitive devices (ESD)!
-

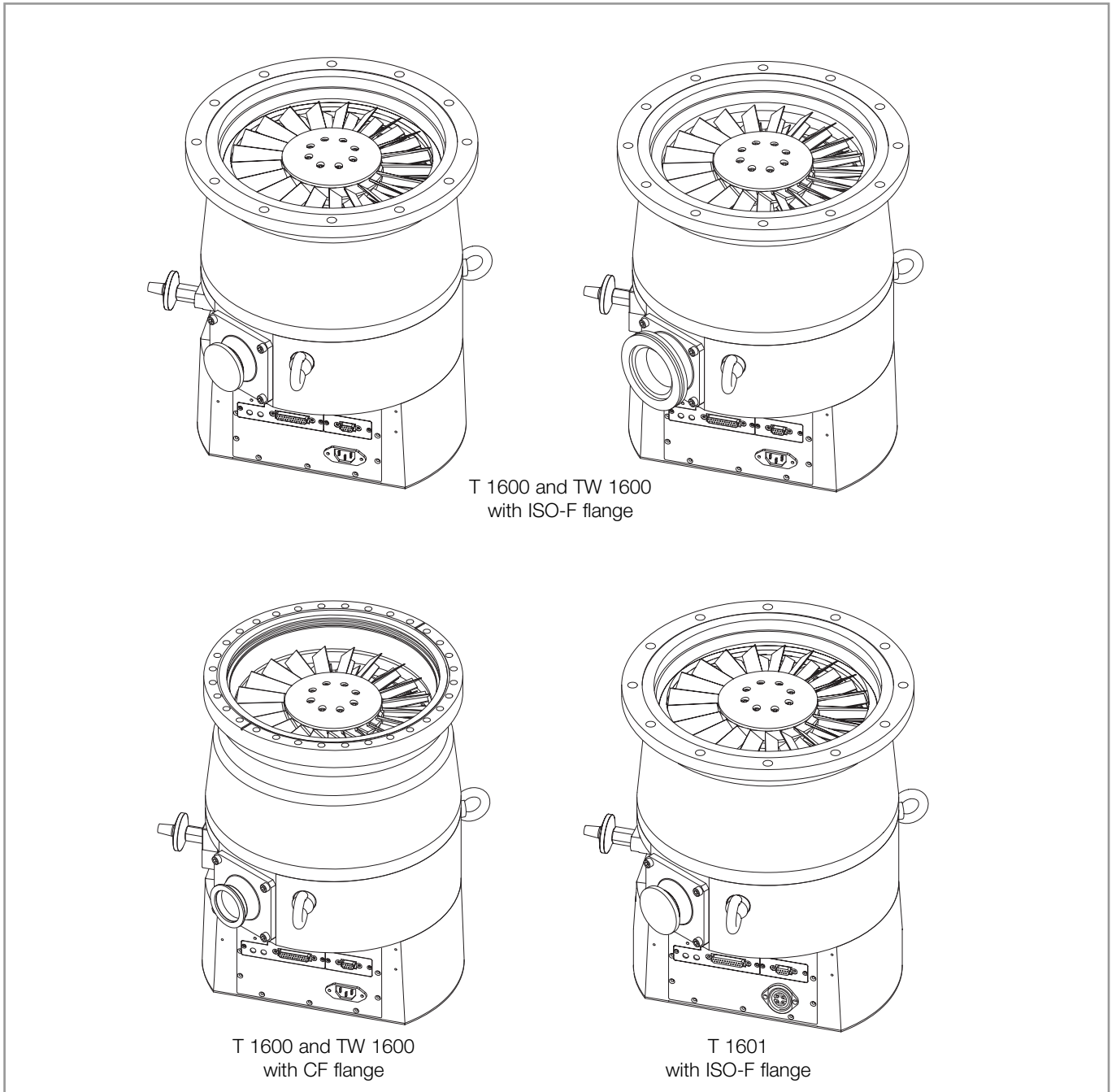


Fig. 1.1 TURBOVAC

Description

1 Description

The TURBOVAC T 1600, T 1601 and TW 1600 are turbomolecular pumps featuring lifetime lubricated ceramics ball bearings. They have been engineered to pump vacuum chambers down to pressures in the high-vacuum range.

The **T 1601** has a frequency converter housing which is sealed against condensate water. This allows the use of the pump with higher ambient humidity and higher ambient temperatures. The **TW 1600** has an additional compound stage.

The frequency converter required for operation has been integrated in the pump itself. Operation of the TURBOVAC requires the use of a suitable backing pump.

1.1 Standard equipment

The TURBOVAC is shipped in a sealed PE bag which also contains a desiccant. The desiccant will remain effective for about 1 year.

Included with the pump are:

- for the ISO-F high-vacuum connection: inlet screen, centering ring, support ring and O-ring
- for the KF foreline connection: centering ring, clamping ring and a DN 40 KF O-ring
- for the ISO-K foreline connection: centering ring
- for the pumps equipped with a Profibus interface: a disk with the basic instrument data file (GSD)
- a mains cord with Euro plug
- accessories for the cooling water connection: 2 adaptors G 3/8" – hose nipple LW 13 (Ref. No. 272 75 202), 2 gaskets (Ref. No. 200 11 600)

The purge gas connection has been sealed off. A gas filter (Part No. 200 18 515) with an adaptor for screwing in have been included.

PE=Polyethylene

1.2 Technical data

TURBOVAC		T 1600	T 1600	T 1601	TW 1600	TW 1600
High vacuum port	DN	200 ISO-F	250 ISO-F/ 250 CF	250 ISO-F	200 ISO-F	250 ISO-F/ 250 CF
Max. permissible high vacuum pressure (p_{HV}) for continuous operation ¹⁾	mbar			$5 \cdot 10^{-2}$		
Pumping speed for N ₂ at $p_{HV} \leq 10^{-3}$ mbar	l·s ⁻¹	1280	1550	1550	1000	1420
Forevacuum port	DN	40 KF	40 KF / 63 ISO-K	40 KF	40 KF	40 KF
Max. permissible forevacuum pressure (p_{VV}) at the forevacuum port for N ₂ for continuous operation ¹⁾	mbar	$5 \cdot 10^{-1}$	$5 \cdot 10^{-1}$	$5 \cdot 10^{-1}$	9	9
Max. gas throughput for N ₂ for continuous operation ¹⁾	sccm mbar·l·s ⁻¹	1500 25	1500 25	1500 25	440 7.4	440 7.4
Nominal speed = nominal frequency	rpm Hz			30,000 500		
Minimum speed	rpm			18,000		
Run-up time without load	min			< 10		
Weight	approx. kg			40		
Purge gas port	G			1/4"		
Purge gas				dry ambient air or N ₂		
Purge gas requirement	sccm mbar·l·s ⁻¹			36 0.6		
Max. purge gas pressure, abs.	bar			1.0 - 1.5		
Max. humidity in the purge gas	ppm			10		
Cooling water connections	G			3/8"		
Cooling water requirement				See Section 3.5		
Voltage range, nominal	V			85 - 265		
mains frequency	Hz			50 / 60		
Power consumption						
maximum	VA			1200		
while running up	VA			700		
during normal operation without gas load	VA			300		
Load rating for the relay outputs, max.	V / A			48 / 0.5		
Noise level	dB(A)			39		
Ambient temperature						
during operation	° C ° F	10 to 40 50 to 104	10 to 40 50 to 104	10 to 45 50 to 113	10 to 40 50 to 104	10 to 40 50 to 104
while shelved	° C ° F			- 15 to + 60 5 to 140		
Relative humidity of the air (non-condensing) ²⁾	%	5 to 85	5 to 85	5 to 95	5 to 85	5 to 85
Protection	IP	54	54	67	54	54

1) The maximum values stated in the Technical Data section are individual values which must not be related to other maximum values stated. For example, the maximum gas load must not be utilised at the maximum forevacuum pressure. The settings for safe operation are provided in Fig. 1.3 "Throughput as a function of the inlet pressure".

2) More details in Applied technical standard IEC 721-3-3 3K3/ 3Z1/ 3B1/ 3C1/ 3S2/ 3M1

Description

1.3 Ordering data

TURBOVAC T 1600

	Part No.
DN 250 ISO-F / DN 40 KF	800040V1444
DN 250 ISO-F / DN 63 ISO-K	800040V1544
DN 200 ISO-F / DN 40 KF	800040V1144
DN 200 ISO-F / DN 63 ISO-K	800040V1244
DN 250 CF / DN 40 KF	800040V1844

TURBOVAC T 1600 with PROFIBUS

DN 250 ISO-F / DN 40 KF	800040V2444
DN 250 ISO-F / DN 63 ISO-K	800040V2546
DN 200 ISO-F / DN 40 KF	800040V2144
DN 250 CF / DN 40 KF	800040V2844

TURBOVAC T 1601 with PROFIBUS

DN 250 ISO-F / DN 40 KF	800040V4444
-------------------------	-------------

TURBOVAC TW 1600 with PROFIBUS

DN 200 ISO-F / DN 40 KF	800041V2144
	800041V2148 (painted black)
DN 250 ISO-F / DN 40 KF	800041V2444
DN 250 CF / DN 40 KF	800041V2844

Seal kit	Ref. No. 200 09 763
----------	---------------------

Mains cord with US plug	on request
-------------------------	------------

Accessories for RS 232 interface

PC software "Turbo.Drive Server" for Windows 95 and better, CD ROM

- Display, change, save and compare parameter lists
- Integration of customer's software
- Record parameter data

Part No. 800110V0102

The software can also be downloaded from www.oerlikon.com by selecting Oerlikon Leybold Vacuum → Documentation → Download Software.

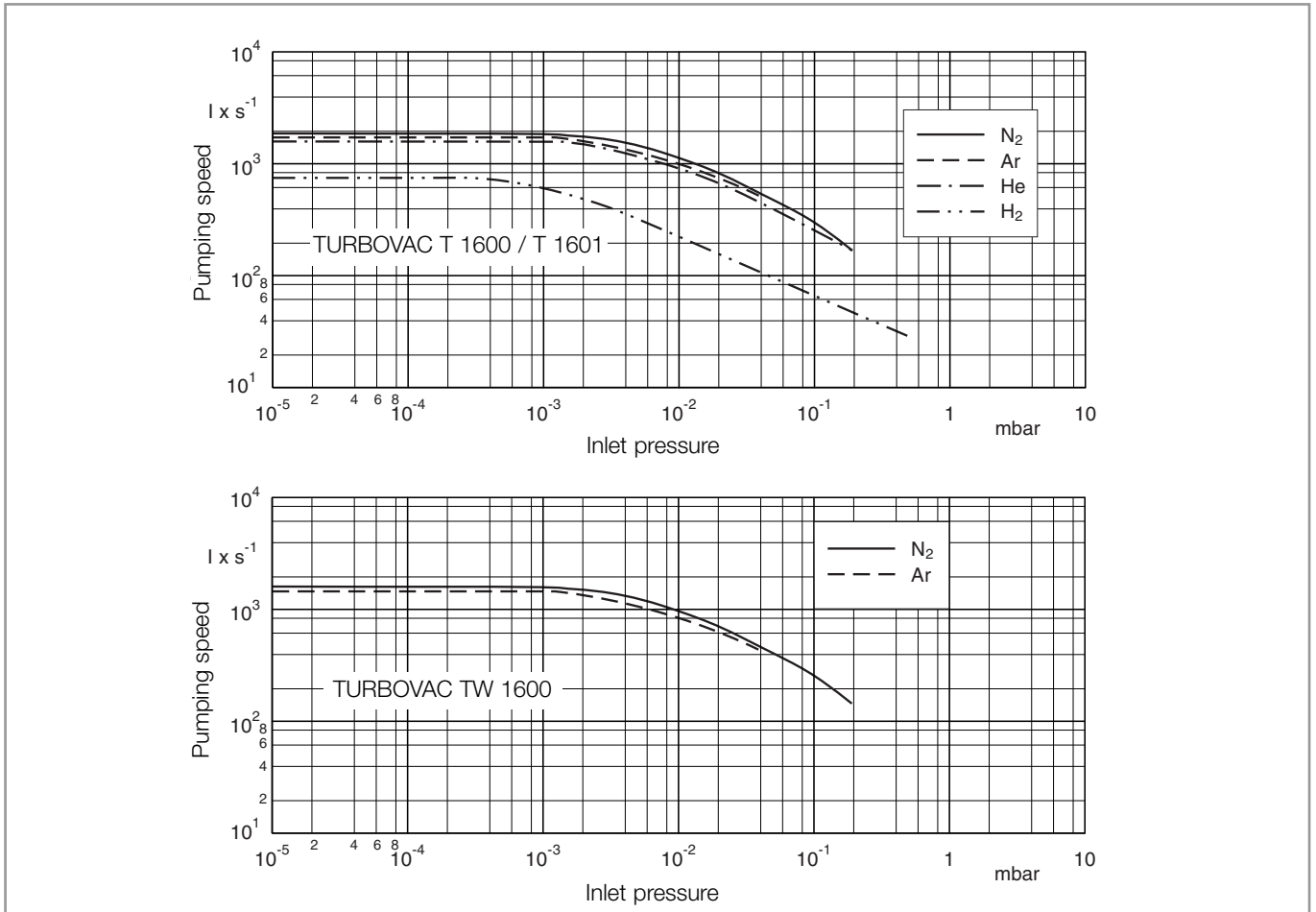


Fig. 1.2 Pumping speed curves

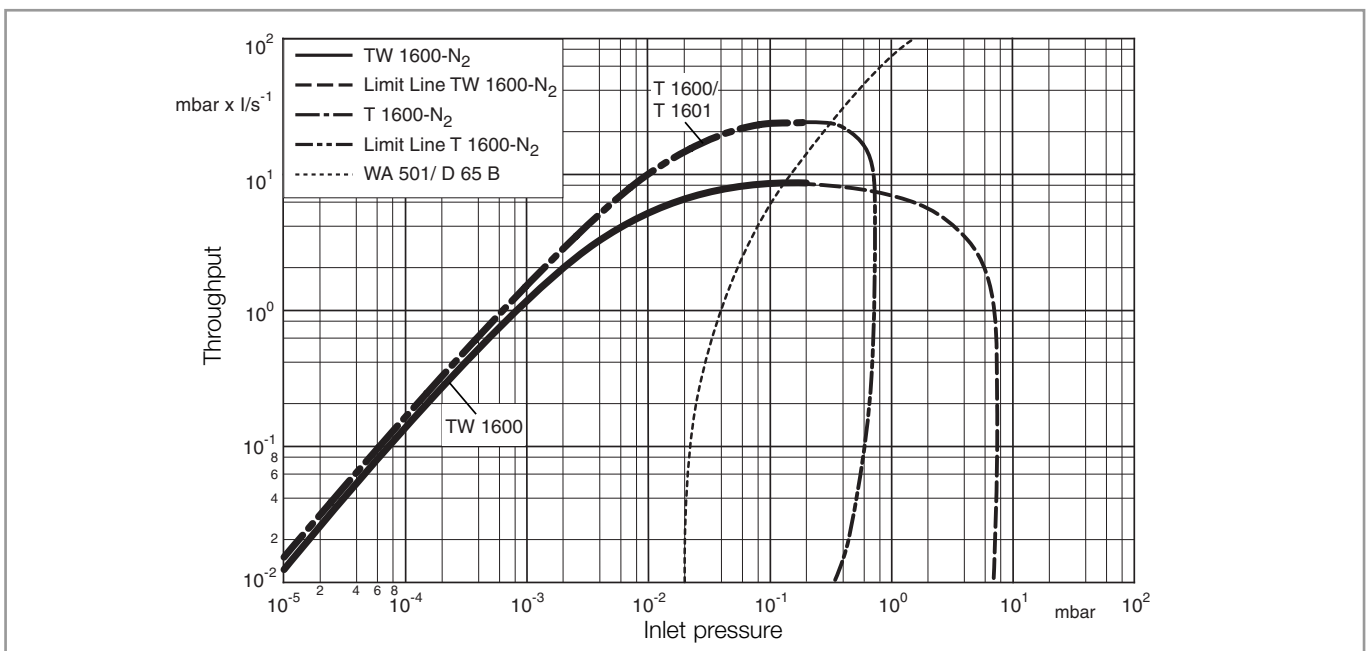
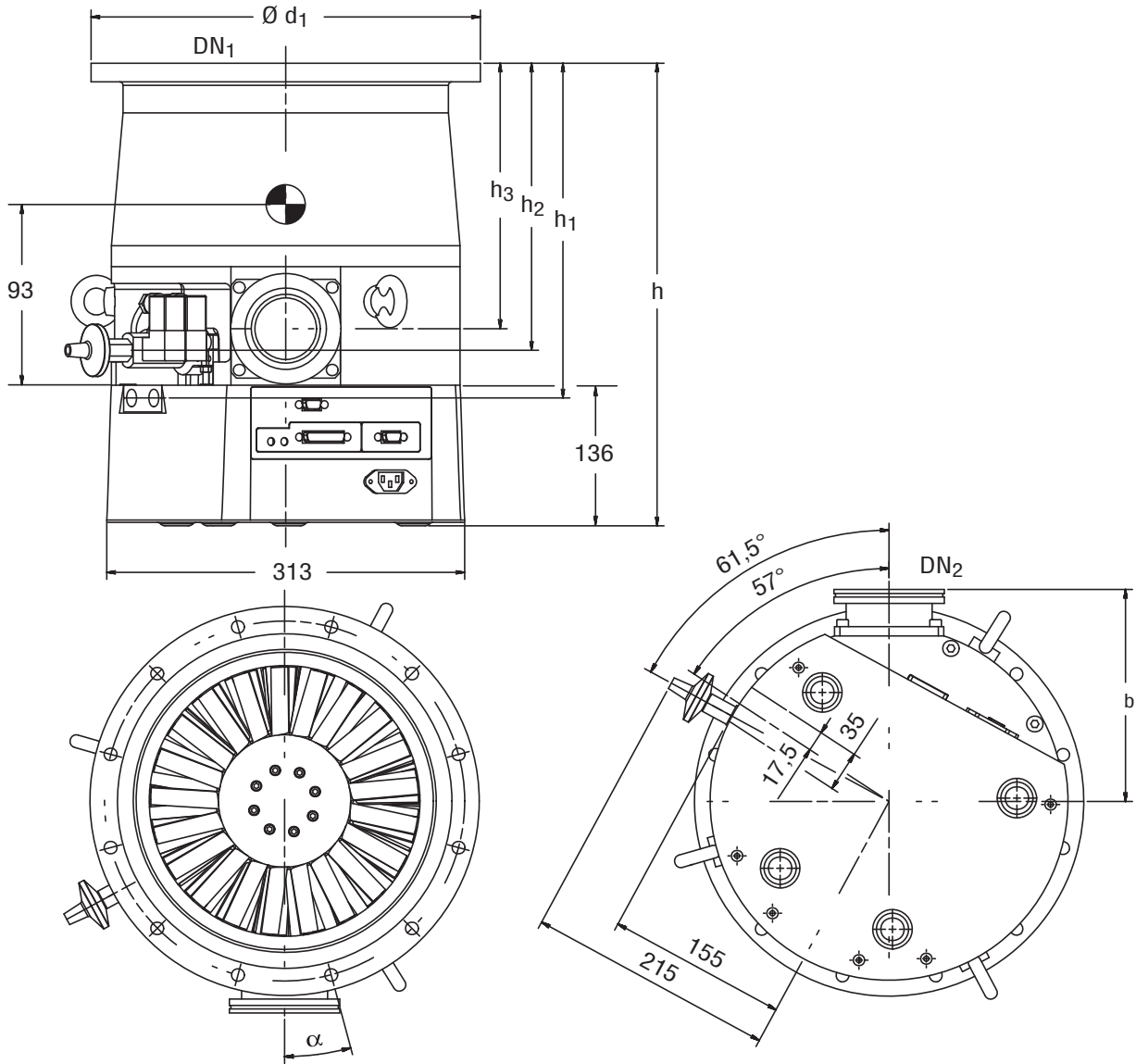


Fig. 1.3 Throughput as function of the inlet pressure

Description



	d_1	h	h_1	h_2	h_3	b	α
T 1600							
DN 200 ISO-F / DN 40 KF	285	440	315	275	255	177	15°
DN 200 ISO-F / DN 63 ISO-K	285	440	315	275	255	182	15°
DN 250 ISO-F / DN 40 KF	335	413	288	248	228	177	15°
DN 250 ISO-F / DN 63 ISO-K	335	413	288	248	228	182	15°
DN 250 CF / DN 40 KF	305	428	303	263	243	177	5.625°
DN 250 CF / DN 63 ISO-K	305	428	303	263	243	182	5.625°
T 1601							
DN 250 ISO-F / DN 40 KF	335	413	288	248	228	177	15°
TW 1600							
DN 200 ISO-F / DN 40 KF	285	440	315	275	255	177	15°
DN 250 ISO-F / DN 40 KF	335	413	288	248	228	177	15°
DN 250 CF / DN 40 KF	305	428	303	263	243	177	5.625°

Fig. 1.4 Dimensional drawings for the TURBOVAC; dimensions in mm

Transport and storing

2 Transport and storing

Remove the equipment from the transportation box and keep the packaging. Make sure that the product has not been damaged during transportation. If this unit is damaged contact your carrier and inform Oerlikon Leybold Vacuum if necessary. For storage of the product, use the packaging provided.

Be careful not to damage the sockets and connections during transportation.

Do not stand below the pump while connecting or removing the turbomolecular pump.

When moving the pump you must use the crane eyes provided on the pump.

The turbomolecular pump is shipped in a sealed PE bag with desiccant. Do not open the sealed package until immediately before installing.

Do not remove the covers and blanking flanges until you are ready to make the connections, to ensure that the turbomolecular pump is installed under the cleanest possible conditions.

Turbomolecular pumps which were not operated for a period of over 12 months should be returned to us. For more information on this please contact your local sales partner.

Do not store pump and accessories in a moist atmosphere so as to prevent these items from suffering corrosion.

Keep the packaging

NOTICE



CAUTION



3 Installation

3.1 Conforming utilization

The turbomolecular pump is intended for generating a vacuum. It is suited for non-corrosive processes only.

The turbomolecular pump must be bolted to a rigid vacuum system and connected to a suitable backing pump.

The turbomolecular pump must only be operated with correspondingly specified frequency converters, the special connecting cables and mounting bolts.

Both pump and frequency converter are intended for being operated within closed rooms.

The use of any accessories which have not been specified by Oerlikon Leybold Vacuum is only allowed after approval by Oerlikon Leybold Vacuum.

3.1.1 Non-conforming utilization

Non-conforming utilizations for both pump and frequency converter are among others:

- Pumping of gases and vapours for which the materials of the pump are unsuitable.
- Operation in connection with processes in which GaAs (gallium arsenide) is being pumped.
- Pumping of gas mixtures with an oxygen content of > 21%.
- Pumping of corrosive gases and dust containing gases without reverting to purge gas operation.
- Pumping of condensable vapours without suitably controlling the temperature of the pump. Upon compression within the pump, these vapours may condense or form deposits.
- Pumping of dusts and solids without the use of suitable screens and filters.
- Operation at an inadmissibly high forevacuum pressure.
- Operation at inadmissibly high gas loads.
- Utilization of both pump and frequency converter in explosion hazard areas.
- Non-compliance of the specified maintenance and servicing intervals for both pump and frequency converter.
- Operation of the pump and drive electronics in environments which demand protection type IP 54 (T 1600 and TW 1600) or IP 67 (T 1601) or higher and where the installation site is over 1000 m the above sea level.
- Utilization in systems and pump systems in which the pressure may exceed 1.4 bar abs.
- Operation with an inadequately mounted pump.
- Operation without having flanged the pump to the system or without having connected it to a suitable backing pump.

- Operation with additional heat sources involving thermal radiation, thermal conduction via the high vacuum or the forevacuum flange, strong magnetic fields or very hot process gases, for example.
- Use in systems in which impact stress and vibrations or periodically occurring forces affect pump, frequency converter and cables.
- Operation on moving system or system components (locks or movable pump systems, for example).
- Operation at vibration absorbers and vacuum components (gate valves, valves) which are not capable of sustaining the specified deceleration torque should the pump rotor seize.
- Stepping on pump, add-on parts, drive electronics, flanges and cables to climb onto the system.
- Fitting of add-on parts to the forevacuum flange which cause an inadmissible high load.
- Removing, covering or obstructing warning notices.
- Standstill or storing of pump and drive electronics without suitable sealing-off and drying. Storing in a humid atmosphere can cause corrosion.
- Conversions, manipulations and maintenance work by personnel not authorised by Oerlikon Leybold Vacuum.

Any non-conforming utilisation of pump, frequency converter and accessories can result in severe injury and cause damage to components.

WARNING



3.2 Operating environment

The maximum permissible ambient temperature is 45 °C (113 °F). Do not expose the pump or the frequency converter to dripping or spraying water.

If the pump is used within a magnetic field, the magnetic induction at the surface of the pump housing may not exceed:

B = 5 mT if impinging radially and

B = 15 mT if impinging axially.

Install shielding equipment as appropriate if these values are exceeded.

The standard pump version without frequency converter is resistant to radiation up to 10³ Gy.

Places of installation up to 1000 m above sea level (3300 ft) are possible without restrictions. At altitudes over 1000 m heat dissipation by the ambient air is impaired. Please consult us.

The frequency converter must not be operated in explosive gas atmospheres.

Ambient temperature

Magnetic field

Radiation

Places of installation

1 mT (milliTesla) = 10 G (Gauß)

1 Gy (Gray) = 100 rad

Installation

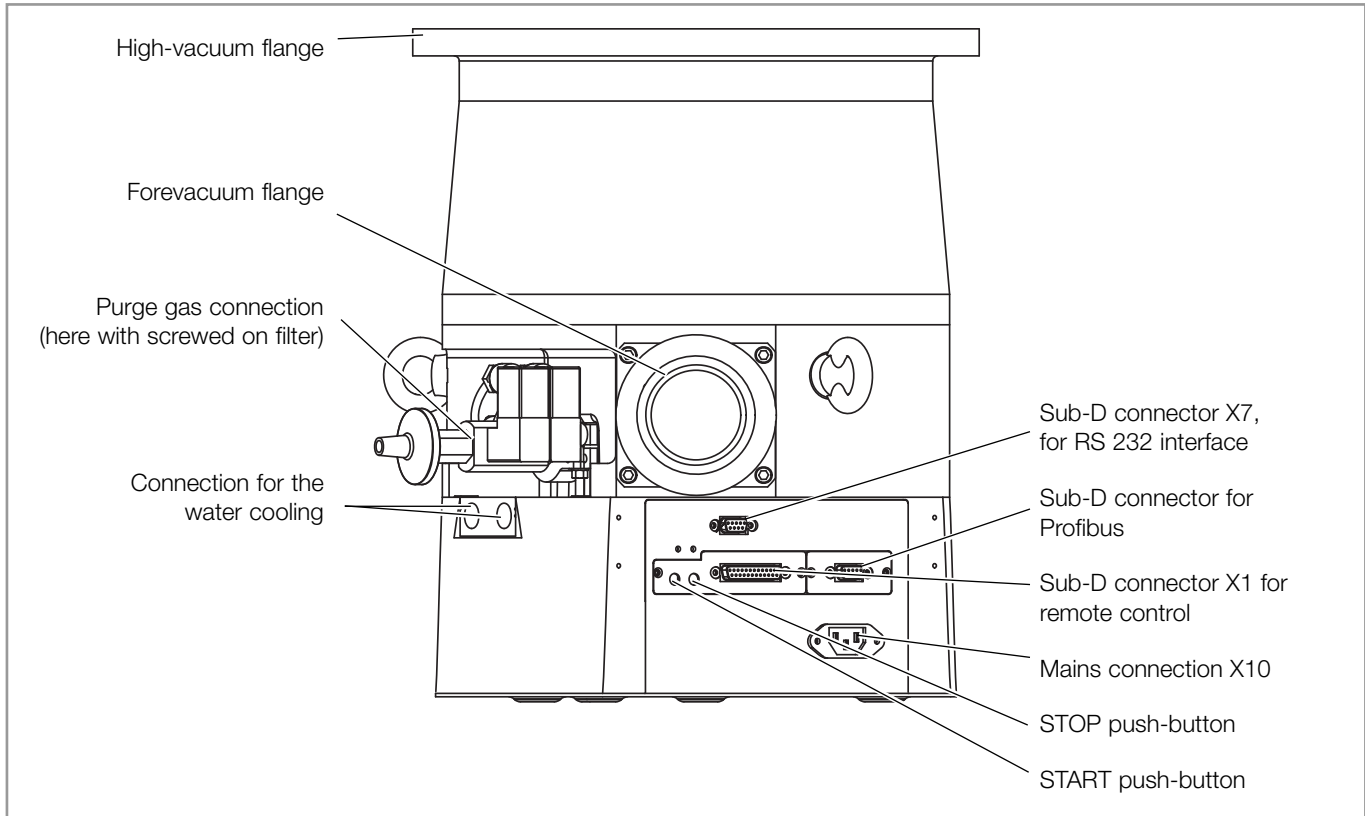


Fig. 3.1 Connections and controls

3.3 Attach the pump to the vacuum chamber

NOTICE



Never touch the rotor. Touching the rotor may cause injury and damage the rotor bearing.

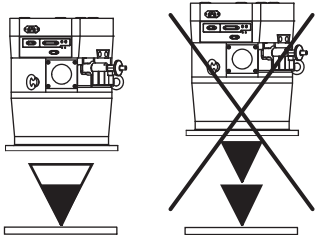
WARNING



The high-vacuum flange must be solidly mounted to the vacuum chamber. Observe Safety Information 0.1.6.

Remove the transport seal from the intake flange and remove the desiccant. Pay attention to maximum cleanliness when connecting.

Set the pump **slowly** and cautiously onto the flange! Axial shocks may **damage the bearings**.



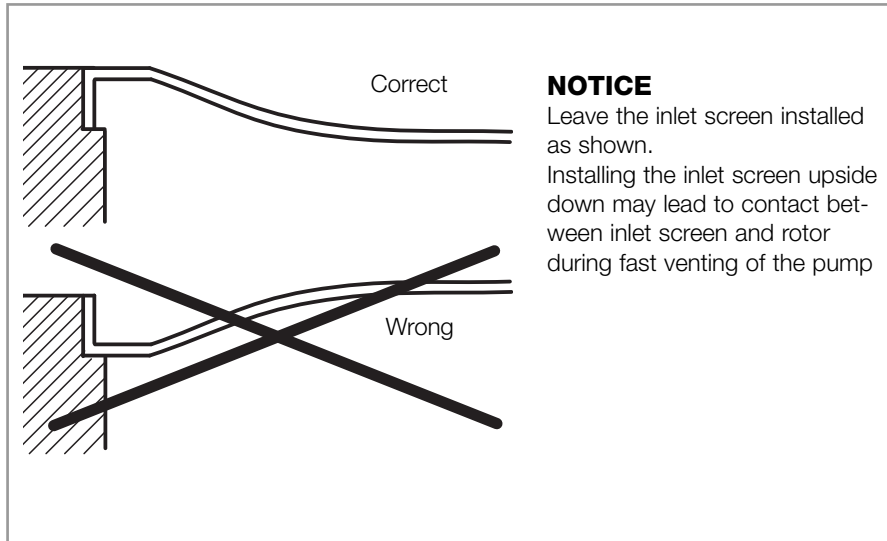


Fig. 3.2 Inlet screen

If the pump should suddenly seize, an ensuing deceleration torque of up to 4500 Nm will have to be absorbed by the system.

In most applications the pump is flanged to the high-vacuum flange at the apparatus. The pump can be mounted and operated in any desired attitude.

Use exclusively flange connecting components and fittings which have been manufactured in accordance with DIN 28403, DIN 28404, ISO 1609 (KF- and ISO-K flange connections) or ISO 3669 (CF flange connections).

The flange material to which the pump is bolted, must have at operating temperature a minimum strength specification of 150 N/mm².

Operation with vibration absorber

The pump is precision balanced and is generally operated without a resonance damper. To decouple extremely sensitive equipment and to prevent transfer of external vibrations to the pump a special resonance damper is available for mounting at the high-vacuum flange.

In this case mount the turbomolecular pump separately. A vibration absorber cannot reliably sustain the high deceleration torque in case of a rotor seizure.

If additional mounting is not possible, then the pump must be protected by a suitable shield during operation.

If several turbomolecular pumps are installed to the vacuum chamber of the same system, there is the risk of interference (vibration interference between the pumps). If such a risk exists please contact Oerlikon Leybold Vacuum Application Support.

The standard mounting arrangement for the pump is adequate to ensure earthquake protection. If required mount the system to the floor or the walls.

Torque when the rotor seizes

Vibration influence

Earthquake protection

Installation

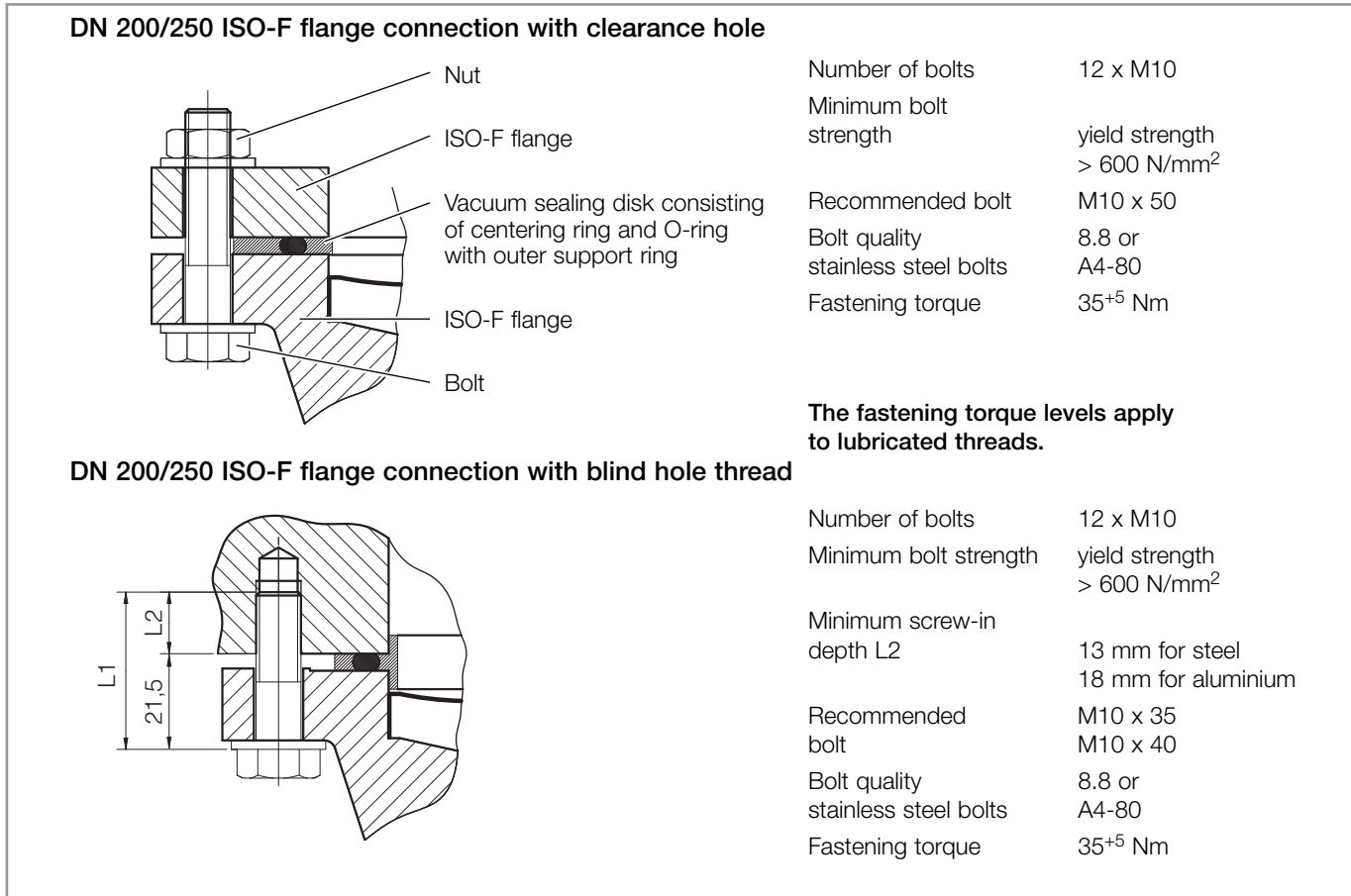


Fig. 3.3 Mounting the DN 200/250 ISO-F high-vacuum flange

NOTICE



Install an inlet screen

Foreign objects which enter the pump through the intake would cause serious damage to the rotor. That's why we recommend to use the installed inlet screen. Damages caused during operation without the inlet screen are excluded from warranty.

When installing the pump, make sure that the inlet screen is not bent. If the inlet screen touches the rotor, the pump will be damaged upon starting it.

If dust could pass from the vacuum chamber into the pump, then a micro-pore filter must be installed between the vacuum chamber and the pump.

Flange mounting for ISO-F flanges

When flanging on the high vacuum connecting flange, place the O-ring on the centering ring. The O-ring must remain in place smooth and untwisted. Thereafter put the outer ring in place.

Mount the turbomolecular pump according to Fig 3.3 and tighten the bolts crosswise step-by-step.

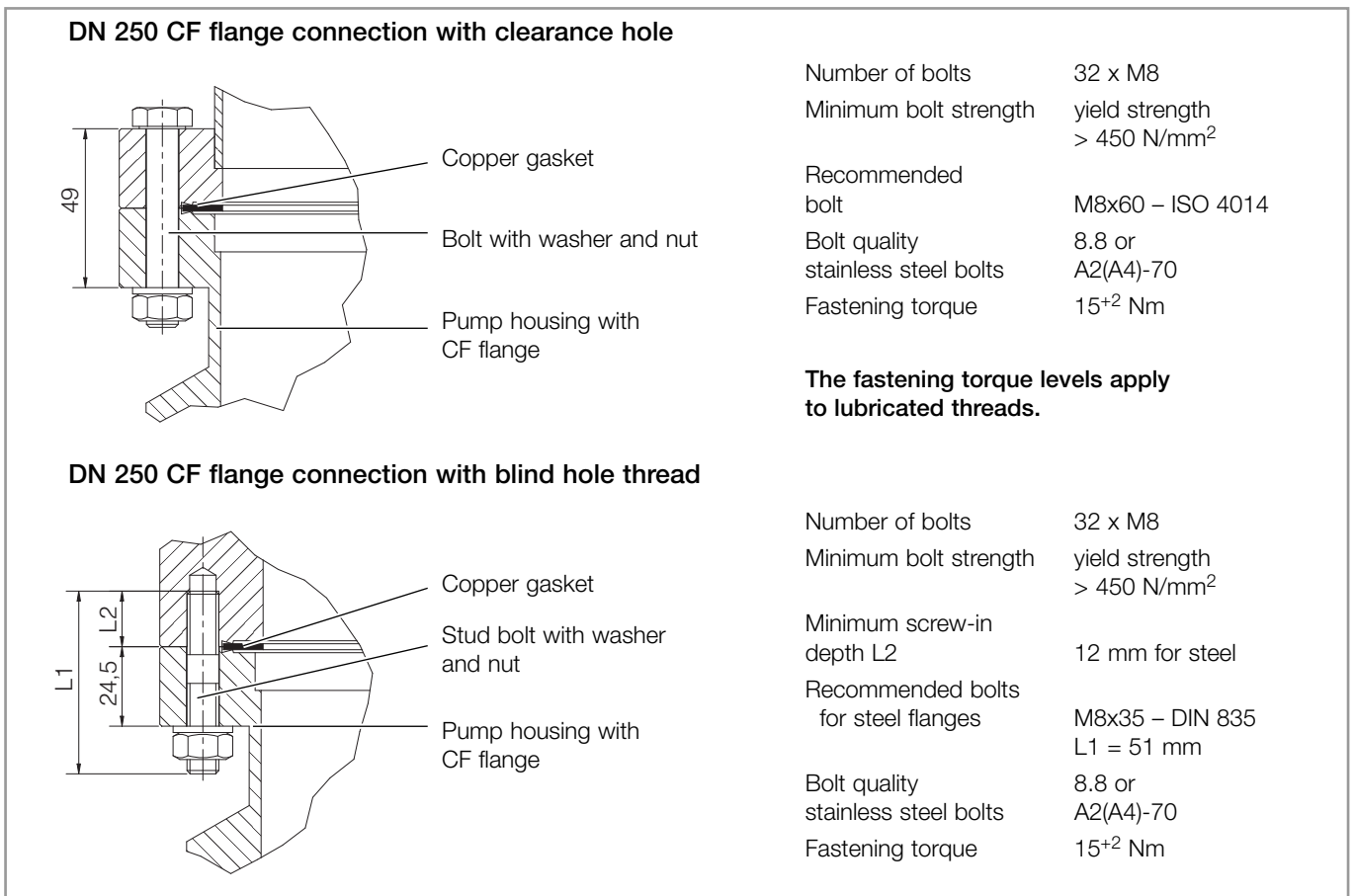


Fig. 3.4 Mounting the DN 250 CF high vacuum flange

The contact surfaces of pump housing, vacuum system and centering ring must be free of grease and dry so as to ensure adequate strength in case the rotor should seize.

When using clamped flange connections with components above the housing or when reducing the diameter (e.g. from DN 200 to DN 160), sudden twisting of the entire pump can be experienced.

Flange mounting for CF flanges

Before fitting, check to ensure that the sealing edge is undamaged. Do not touch the copper gasket and the sealing edge with your bare hands.

The contact surfaces of pump housing, vacuum system and centering ring must be free of grease and dry so as to ensure adequate strength in case the rotor should seize.

Mount the turbomolecular pump according to Fig 3.4 and tighten the bolts crosswise step-by-step.

When the pump shall be baked out, the threads of the bolts should have been lubricated with a high temperature lubricant.

NOTICE



WARNING



NOTICE



Installation

Owing to the deformation of the copper gasket, the fastening torque of all bolts must be checked once more after having completed the installation work.

CAUTION

During operation the pump can get so hot that there is the risk of suffering burns (up to approximately 80 °C). Protect the hot parts against being touched.

Forevacuum pump

3.4 Forevacuum connection

The high vacuum pressure level which can be achieved is a function of the volume of gas flow Q to be pumped and the forevacuum pressure.

We recommend using dry-running Scroll vacuum pumps or TRIVAC rotary vane pumps for this purpose.

Connect the clean forevacuum line. The connecting flanges must be clean and undamaged. The cross section of this line must be so wide that safe operation of the pump can be ensured.

DANGER

The forevacuum line must be tight. Hazardous gases can escape at leaks or the gases being pumped can react with air or humidity. Observe Safety Information 0.4.5.

Safety valve

Fig. 3.8 is a schematic diagram of a pump system incorporating a turbomolecular pump and a TRIVAC forevacuum pump with an anti-suckback valve.

A separate safety valve must be provided for oil-sealed forevacuum pumps without an anti-suckback valve. The safety valve prevents oil flowing back from the forevacuum pump into the turbomolecular pump when the system is not running.

Adsorption trap

To ensure that the forevacuum space at the turbomolecular pump is kept largely free of oil vapors during operation, as well, we recommend installing an adsorption trap in the forevacuum line. Alternatively purge the forevacuum line with inert gas. In this case the pressure in the forevacuum line must be over 10^{-2} mbar.

Provide a roughing line to achieve the shortest cycle times.

Ensure that the pump is sufficiently isolated against vibrations generated by the forevacuum pump.

No forces from the piping system may be allowed to affect the turbomolecular pump. Support the piping correspondingly or decouple through flexible joints.

3.5 Connect the cooling

The TURBOVAC needs to be cooled with water.

Cooling water specifications

Feed temperature	15 - 42 °C 59 - 108 °F
Feed pressure	3 - 7 bar absolute
Cooling water requirement	See Fig. 3.5
Appearance	colourless, clear, free of oils and greases
Sediments	< 250 mg/l
Particle size	< 150 µm
pH value	7 - 8.5
Overall hardness (total alkaline earths)	max. 20°dH German hardness scale (= 3.57 mmol/l)

Connecting the cooling water

Screw on the cooling water lines.

Adjust the cooling water temperature so that the formation of condensate is avoided. The T 1601 is not sensitive to condensate.

The cooling water supply must be switched on and off together with the pump.

Avoid formation of condensate

3.6 Connect the purge gas and venting valve

Regarding suitable gases, refer to Section 4.1, for the venting facility, refer to Section 4.6.

The TURBOVAC is equipped with a purge gas and venting valve.

The purge gas and venting valve can only be opened via control connector X1 or the Profibus interface. Thus when operating the pump via the START and STOP push-buttons no purge gas and venting gas may be admitted into the pump via the purge gas valve.

When having to decide which gases need or not need to be pumped with purge gas we are available to provide assistance.

When operating the pump with purge gas, the pump needs to be vented via the purge gas valve after having shut down the pump, see Section 4.6.

Consider the additional purge gas flow when selecting a suitable backing pump.

The pressure in the pump must not exceed 1400 mbar (0.4 bar over-pressure). Observe Safety Informations 0.1.2 to 0.1.5.

WARNING



Installation

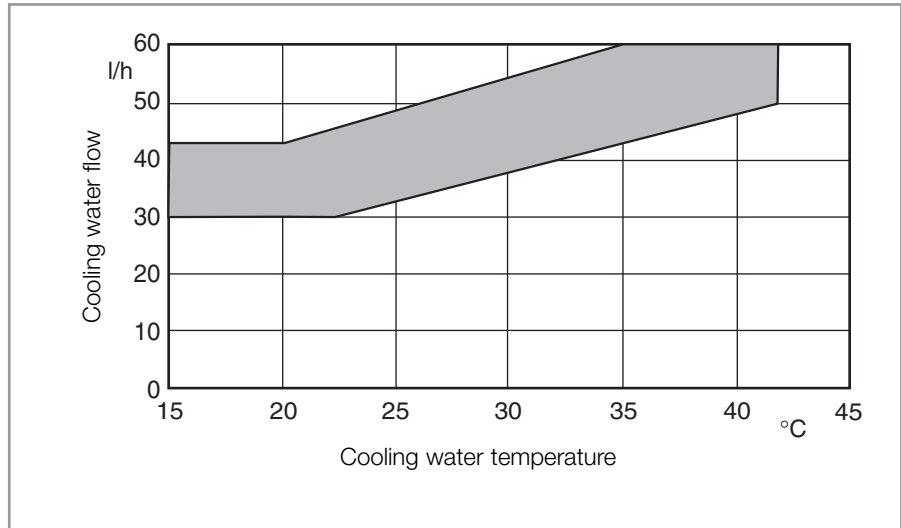


Fig. 3.5 Cooling water requirements

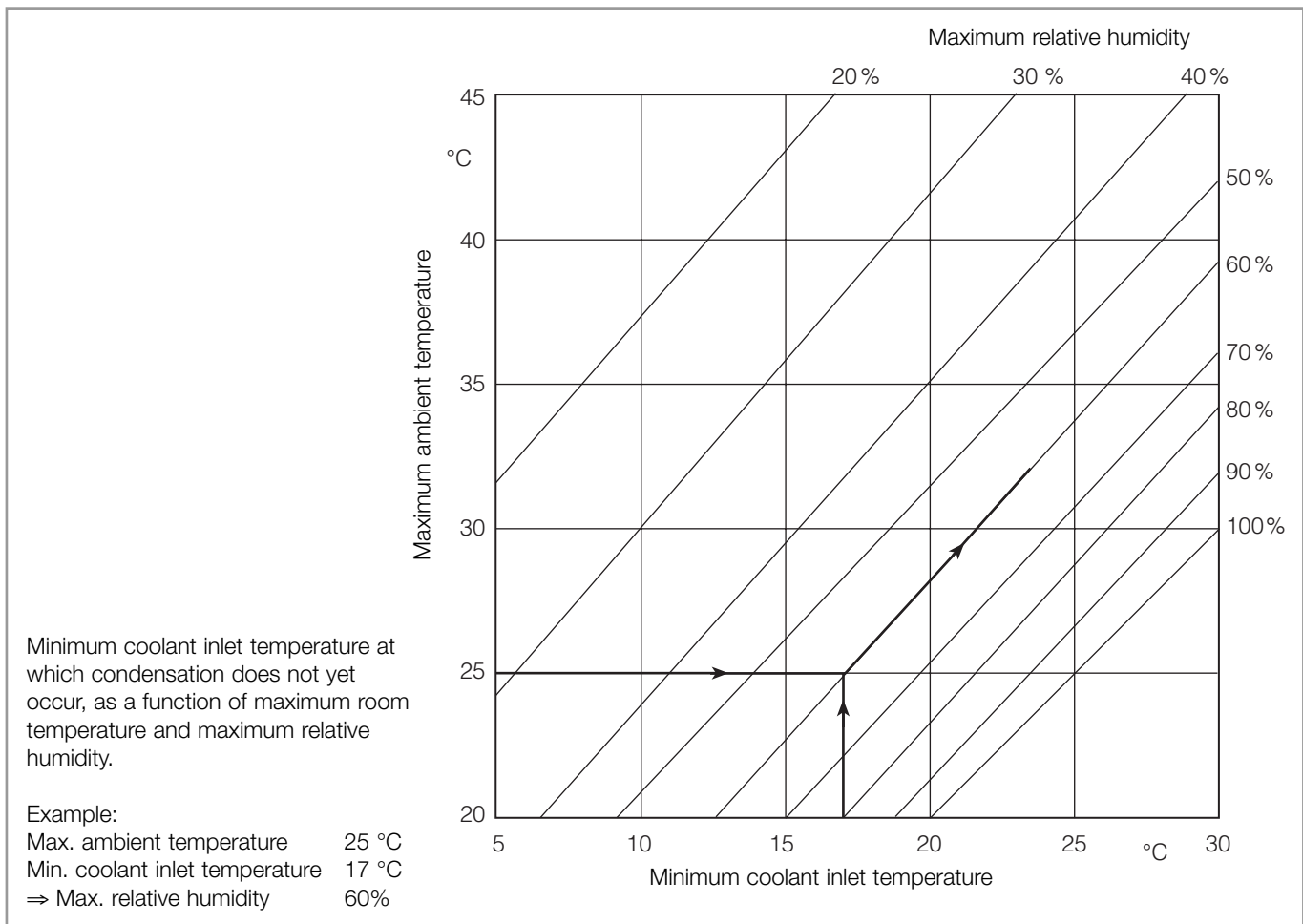


Fig. 3.6 Dewpoint diagram

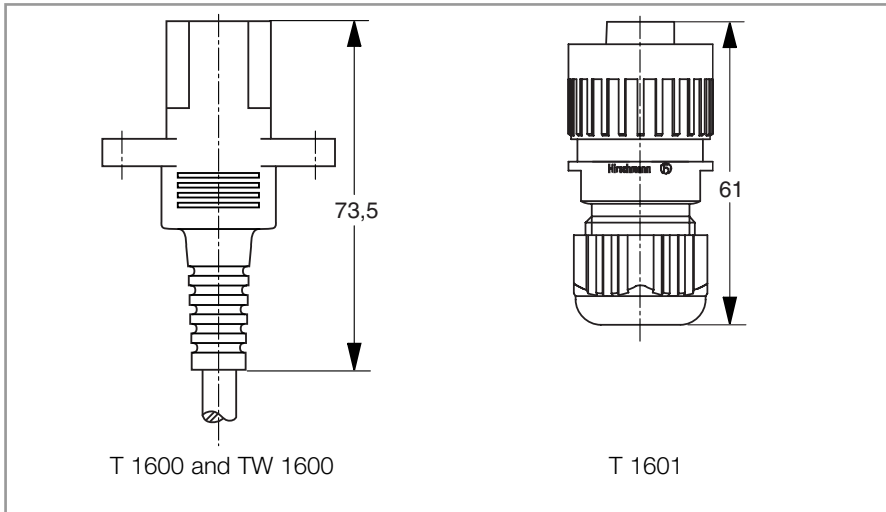


Fig. 3.7 Pump side plug of the mains cord

3.7 Electrical connection

Observe Safety Informations 0.2.

In the case of all electrical connections the plugs can be protected against coming loose on their own when using the right kind of plug.

Insert the mains cord at X10 and connect it to the mains.

In order to protect the mains cord against coming loose, use the supplied mains cord or a plug in line with the recommendations provided in Fig. 3.7.

T/TW 1600

Compliance with IP 54 is only ensured with all plugs in place and only when using suitable plugs.

T 1601

The plugs are sealed on delivery. Remove the caps only when a plug is used. The plugs on the cables must be suitable for the type of protection **IP 67**.

When no operation with purge gas is required you may operate the pump via the START and STOP pushbuttons; see Section 4.

How to connect the control connector X1 is described in Section 4.3.1. When the pump is being operated via the control connector X1, it can no longer be operated via the START and STOP pushbuttons.

For information on the Profibus interface see Section 4.3.3. When the pump is being operated via the Profibus interface, it can no longer be operated via the START and STOP pushbuttons or via the control connector X1.

WARNING



Mains cord

Compliance with protection

Control connector X1

Profibus

Installation

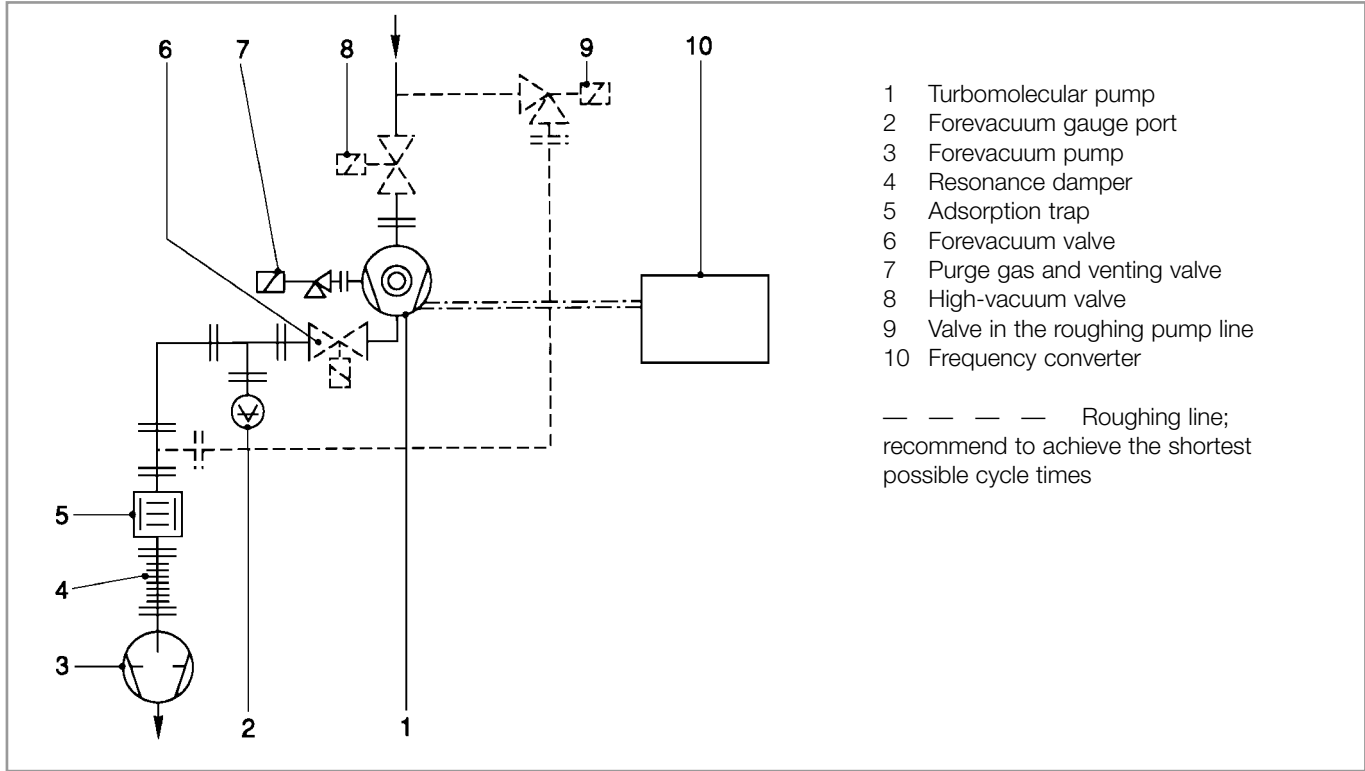


Fig. 3.8 Schematic of a turbomolecular pump system

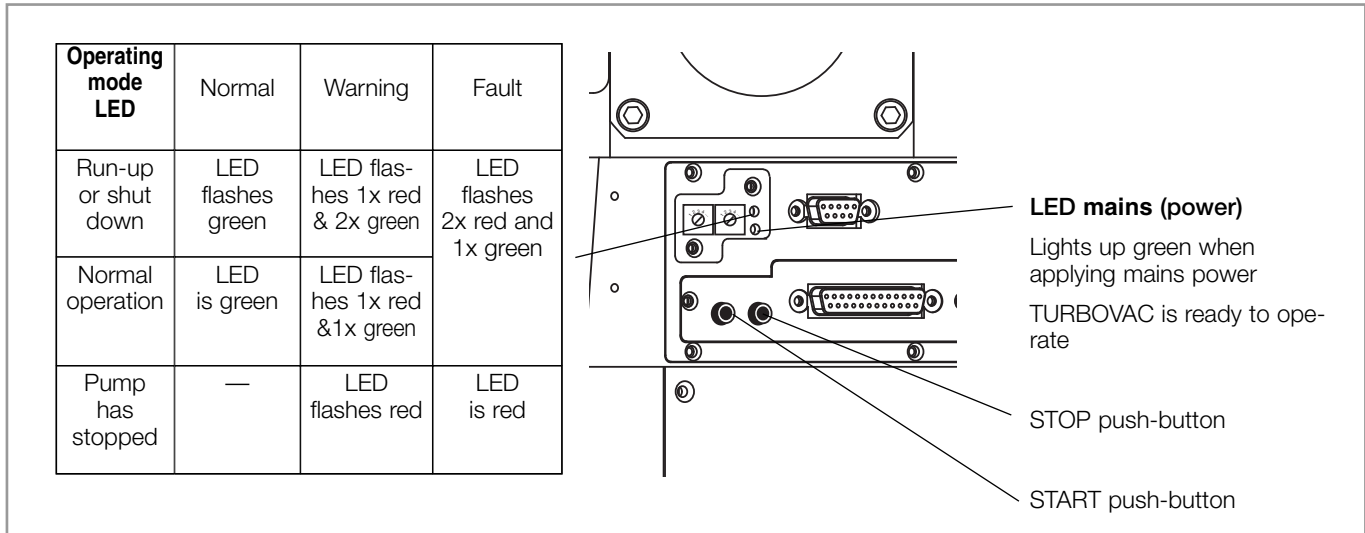


Fig. 4.1 LEDs and controls

4 Operation

The pump may be operated in three different ways:

1. **Via the START and STOP push-buttons.** However, in this mode no purge gas may be admitted and the pump can not be vented via the purge gas valve.
2. **Via control connector X1;** see Section 4.3.1. When the pump is being operated through the control connector X1, it can then no longer be operated using the START and STOP push-buttons.
3. **Via the Profibus interface;** see Section 4.3.3. When the pump is being operated through the Profibus interface, it can then no longer be operated using the START and STOP push-buttons nor can it be controlled through the control connector X1.

4.1 Media compatibility / purge gas

The TURBOVAC is suitable for pumping air and clean gases.

If reactive gases in low concentrations must be pumped operate the pump with purge gas.

We would be glad to consult with you as regards the media which can safely be handled with this unit.

Install a micropore filter when pumping media which contains dust.

Suited for venting or purging are all gases,

- which will not cause corrosion or pitting in aluminium and steel and
- which in connection with process deposits in the pump will not cause corrosion or sticking.

For venting and as the purge gas we recommend inert gases like nitrogen or argon. The temperature of these gases should be between 5 °C and 80 °C, max. relative humidity should not exceed 10 ppm.

The gas must be clean.

In individual cases and after consultation also dry, filtered, oil-free air or filtered ambient air may be used (filter mesh < 1µm).

Change the filters after some time, at least annually.

4.2 Start-up

Turbomolecular pumps which were not operated for a period of over 12 months should be returned to us. For more information on this please contact your local sales partner.

Suited gases

Interfaces

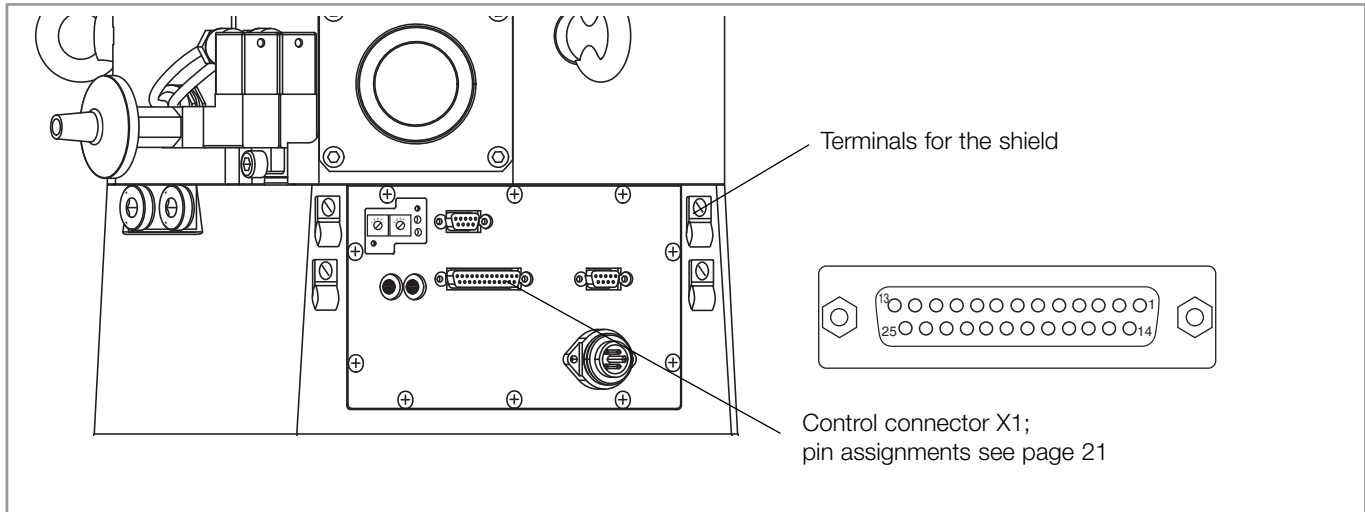


Fig. 4.2 Control connector X1

4.3 Interfaces

4.3.1 Control connector X1

Observe the compliance with the type of protection, see Section 3.7.

Connect control connector X1. The pin assignments are provided on next page. Given in Fig. 4.3 is an example of how to connect a remote control unit. Instead of switches, relays may also be used in the remote control unit.

For an overview on the relays see below.

NOTICE

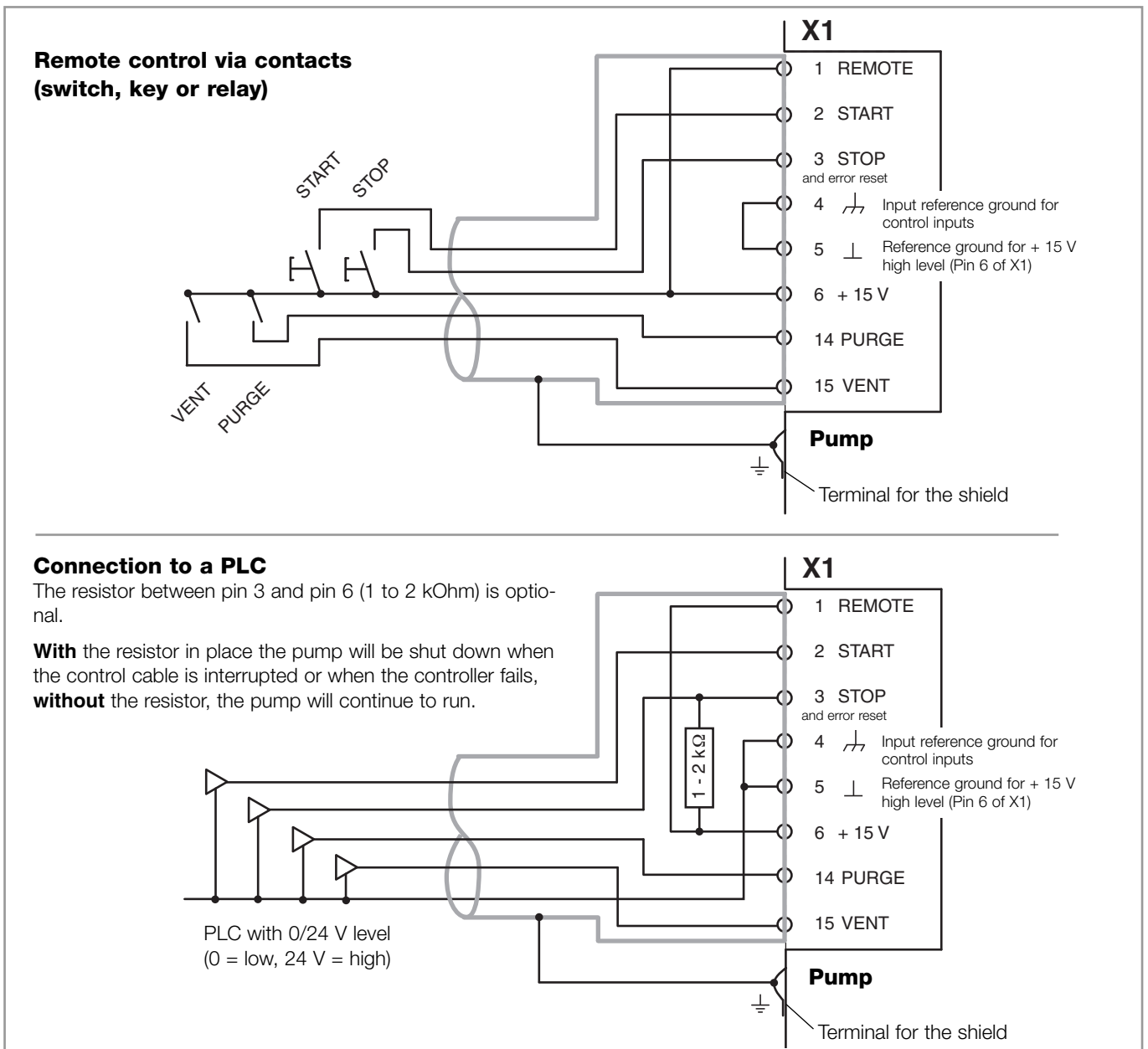


Pin 6 (+15 V) is not protected against external voltages exceeding 15 V.

Shield













Observe the EMC requirements when connecting the control cables.

In the case of exceptionally high electromagnetic interference levels we recommend that you additionally connect the shield of the control cables to the shield terminals. For this strip the insulation on the control cable by about 1 cm and connect the cable at this point to the terminal.



Interfaces

Relay functions

Pin	Relay		Possible cause	
18	Warning n.o.		Motor power of the pump is too great due to excessively high pressures or gas throughput.	<p>“Too high” means that the measured values are significantly higher than those for normal operation and that in the case of further operation the operator will have to expect that the pump will shut down.</p> <p>The relay is energised when one or more warnings are present.</p>
19	Warning com.		Because of excessive loading the pump is not able to maintain its nominal speed.	
20	Warning n.c.		<p>The temperature at one bearing is too high.</p> <p>The temperature of the motor is too high.</p> <p>The self test of the frequency converter which is run upon applying the mains power will indicate that maintenance is due.</p> <p>Upon applying the mains power it was found that the clock is faulty (possibly an exhausted battery).</p>	
8	Fault n.o.		Pump was overloaded for quite some time.	<p>As soon as this relay picks up the pump is shut down.</p> <p>Note: The relay picks up when the pump is in undisturbed operation.</p>
9	Fault com.		The minimum speed was not attained within a certain time.	
21	Fault n.c.		<p>Speed has dropped below the minimum.</p> <p>Motor or bearing temperatures have exceeded the limit.</p> <p>Internal electrical fault.</p>	
10	Normal n.o.		Rotor speed has attained 95% of its nominal speed (= normal operation).	The relay picks up as soon as the normal operation threshold is attained.
11	Normal com.			
23	Normal n.c.			
12	Pump running n.o.		Speed of the pump < 3 Hz (Pump has arrived at standstill)	The relay picks up when the pump has arrived at standstill (f < 3 Hz).
13	Pump running com.			
25	Pump running n.c.			

Pin assignment for the control connector X1 (female)

Pin	Assignment	Description for the signal	
1	Floating control input	Remote control [H]	must be [H] so that the inputs Start [H], Stop [H], purge gas [H], venting [H] are enabled , disables START/STOP via the push-buttons
2	Floating control input	Start [H]	High pulse from prog. cont. starts the pump (pulse ≥ 1 s)
3	Floating control input	Stop [H]	High pulse from prog. cont. stops the pump (pulse ≥ 1 s)
4	Floating	Reference ground for the floating control inputs	
5	Power supply ground	Reference ground for prog. cont. H level (pin 6)	
6	Prog. cont. H signal	Prog. cont. H level with reference to pin 5, $\geq +15$ V, 80 mA max.	
7	Analog output	Programmable analog output, range: 4 to 20 mA adjustable to; bearing temperature top / bottom, motor current, speed default: bearing temperature top (4 mA = 0 °C / 20 mA = 100 °C) Set-up: see parameter 30 (function) and parameter 31 (range), can be set up through Profibus interface or service PC via RS 232 (X7)	
8	N.O. contact	Error relay	General error indication; active when no error is present
9	Common contact	Error relay	General error indication
10	N.O. contact	Normal operation relay	Full speed almost reached; activated when setpoint frequency has been reached
11	Common contact	Normal operation relay	Full speed almost reached
12	N.O. contact	Pump running relay	Active at speeds < 3 Hz
13	Common contact	Pump running relay	Active at speeds < 3 Hz
14	Floating control input	purge gas [H]	Prog. cont. H activates purge gas valve
15	Floating control input	Venting [H]	Prog. cont. H activates venting valve
16	Not used		
17	Analog ground	Reference ground for analog input and output (pin 7 and pin 24)	
18	N.O. contact	Warning relay	General error indication; active when warning is present
19	Common contact	Warning relay	General error indication
20	N.C. contact	Warning relay	General error indication; active when no warning is present
21	N.C. contact	Error relay	General error indication; active when no error is present
22	Floating control input	Standby [H]	Enables standby speed (standby speed is defined through parameter 150; see list of parameters)
23	N.C. contact	Normal operation	Full speed almost reached; active when setpoint relay frequency has been reached
24	Analog input (see Fig. 4.4)	Speed setpoint	0 V = minimum speed (parameter 20, default 300 Hz) 10 V = nominal speed (parameter 24, default 500 Hz) Input open : Nominal speed, proportional increase
25	N.C. contact	Pump running relay	Active at speeds < 3 Hz
S	Shield	Connected to chassis ground and PE Caution: do not use for potential equalisation or ground connection.	

Prog. cont. = programmable control

[H] = SPS high level 13 ... 30 V

[L] = SPS low level 0 ... 5 V

Interfaces

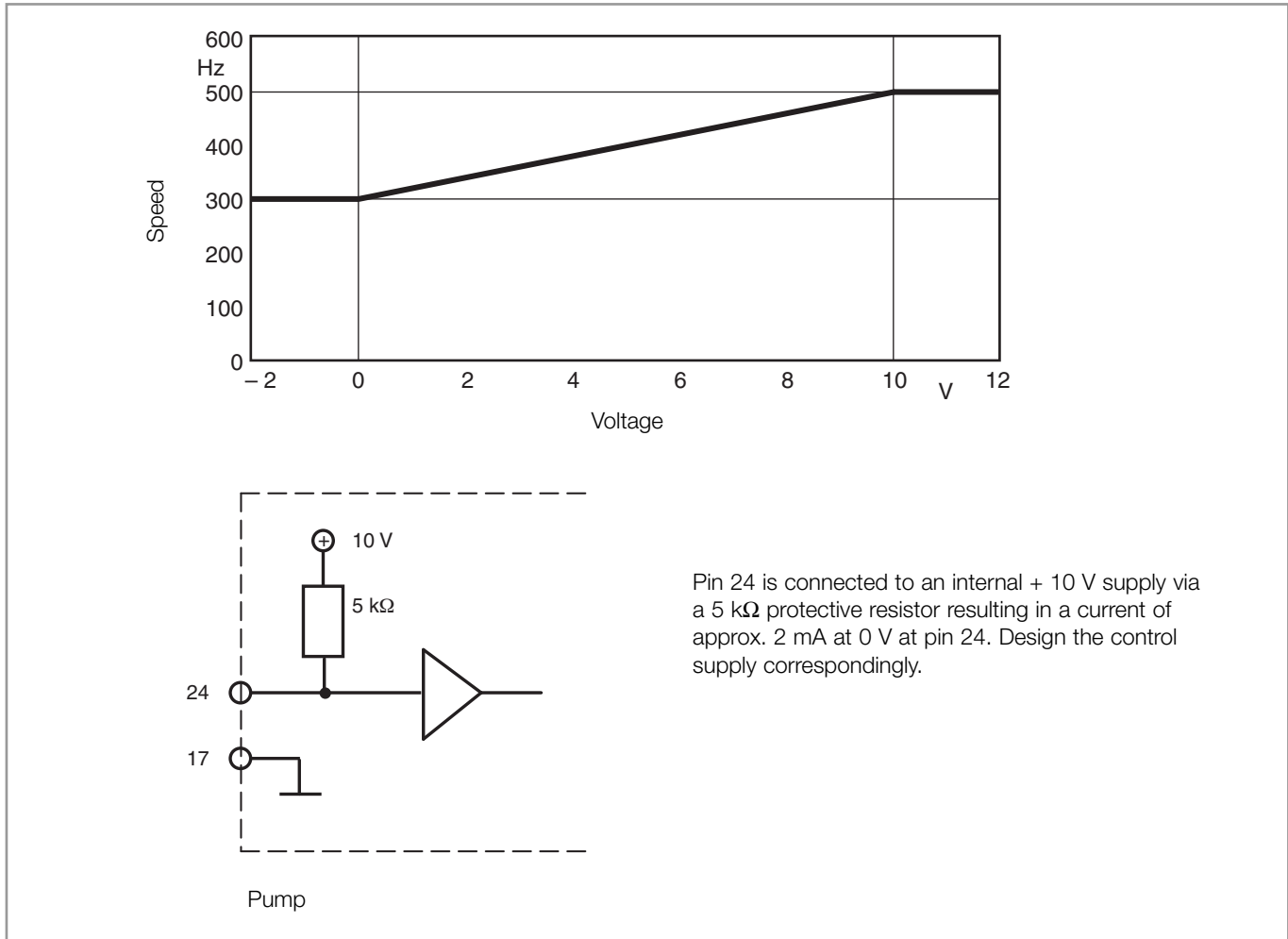


Fig. 4.4 Analog input

Controlling the pump's speed

The TURBOVAC is equipped with an analog input for adjusting the pump's speed.

If pin 24 is **not** connected the normal operation speed is 500 Hz as default.

Through pin 24 you may set the normal operation speed to values between 300 and 500 Hz. No further adjustments are necessary on the pump when wanting to use this analog input.

NOTICE



A dynamic speed adjustment is not permissible. The setpoint speed may be set up only once within the given limits.

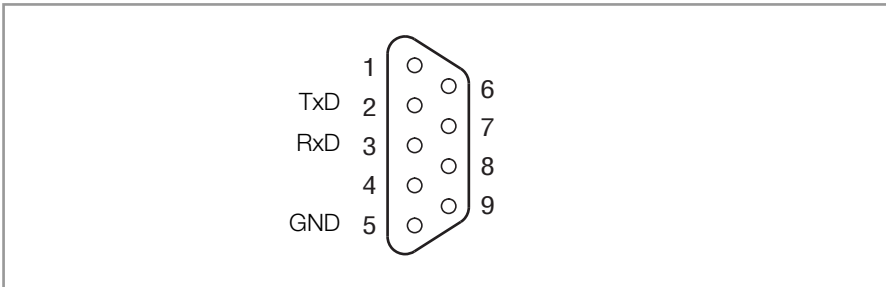


Abb. 4.5 Pin assignment for the socket at the frequency converter (female)

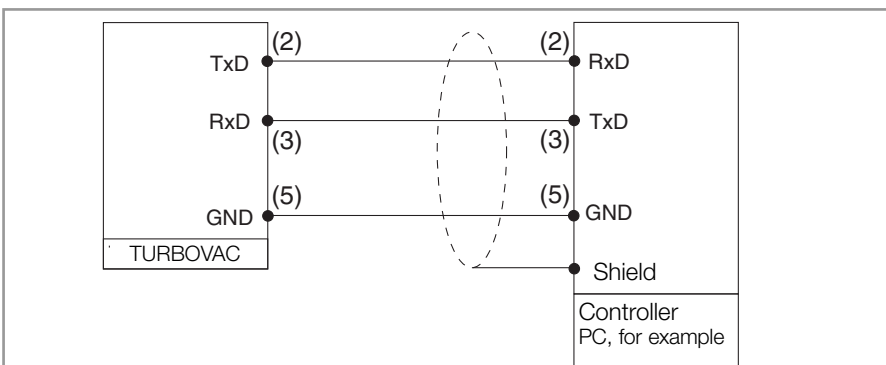


Fig. 4.6 Providing a RS 232 connection

4.3.2 RS 232 service interface

The integrated frequency converter is equipped with an RS 232 interface.

It is configured through the parameters according to the parameter list.

Observe the compliance with the type of protection, see Section 3.7.

The PC software "TURBO.DRIVE Server" allows convenient access by the user to the parameters of the frequency converter.

Standards	DIN 66020
Protocol	acc. to VDI/VDE 3689
Transmission rate	9600 baud fixed
Address range	non-addressable
Max. cable length	5 m
Nominal voltage level (see also "Standards")	at the receiver logic "0": 3 ... 15 V logic "1": - 3 ... - 15 V
Interface connector	9 way Sub-D type, socket on the instrument (female) thread UNC4-40

Note: If on the controlling side an interface in accordance with the PC standard with a 9-pole Sub-D socket is present, then a commercially available straight through cable may be used.

4.3.3 Profibus DP

Upon request the TURBOVAC pump may be equipped with a field bus interface Profibus DP. Through this interface, process automation equipment may easily be hooked up in a network.

The field bus system Profibus DP is described in the standard EN 501 70 (corresponding to the previous standard DIN 19245 Part 1 and Part 3). The engineering and functional features of the Profibus DP have been laid down here. In the case of Profibus DP a difference is made between master and slave units. In this case the master units define the data traffic. They transmit data to the assigned slaves and request data from these. There exists the possibility of operating one or several masters in a system.

The TURBOVAC pump is a slave unit and thus responds when queried by the master. Thus it only supplies data when requested by the master to do so.

GSD - Basic instrument data file

Documented in the GSD file are the capabilities and the scope of the performance offered by a Profibus DP unit. The file format has been laid down in the standard so that software tools of different manufacturers may be used.

The current GSD file is on a disk which has been included with the pump. In addition, the contents of the GSD file are documented in the Annex to these Operating Instructions.

Connection

Observe the compliance with the type of protection, see Section 3.7.

Connect the Profibus via the Profibus DP interface; see Fig.4.7.

Terminating resistor

At the ends of the bus, a terminating resistor must be connected. This is done by means of a special connector. The connections required for this are present in the interface plug. For this refer to the standard.

Use the bus cable SIEMENS-SINEC-L2 for the bus.; P/N.6XV1830-0AH10.

Transmission rate (in kBits/s)	Max. length of a segment (in m)
9.6 - 93.75	1200
187.5	1000
500	400
1500	200
3000 - 12000	100

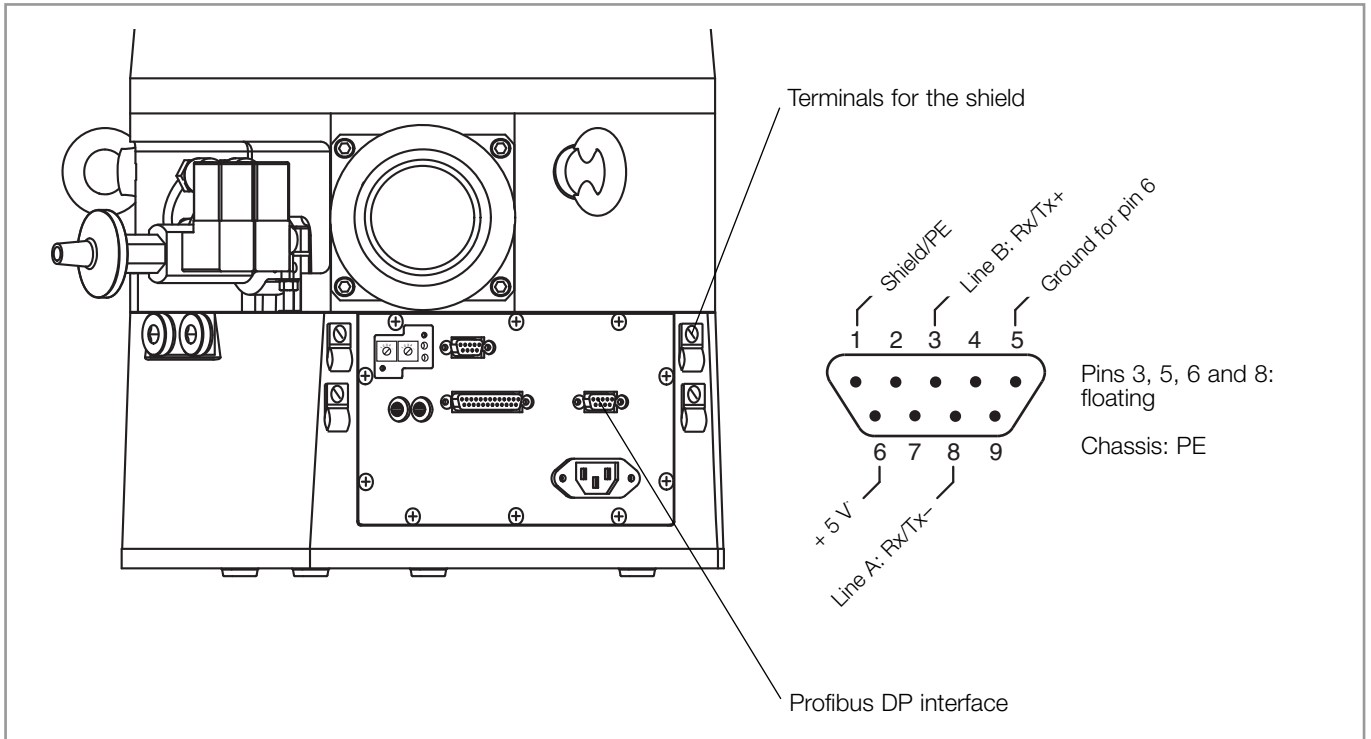


Fig. 4.7 Profibus DP interface

The length of a segment may be extended by using RS-485 repeaters; for example SINEC L2 Repeater RS 485; P/N 6GK1510-OAC00.

In the case of exceptionally high electromagnetic interference levels we recommend that you additionally connect the shield of the bus cables to the shield terminals. For this strip the insulation on the bus cable by about 1 cm and connect the cable at this point to the terminal.

Supported Baud rates

- 9.6 k Baud
- 19.2 k Baud
- 45.45 k Baud
- 93.75 k Baud
- 187.5 k Baud
- 500 k Baud
- 1.5 M Baud
- 3 M Baud
- 6 M Baud
- 12 M Baud

Interfaces

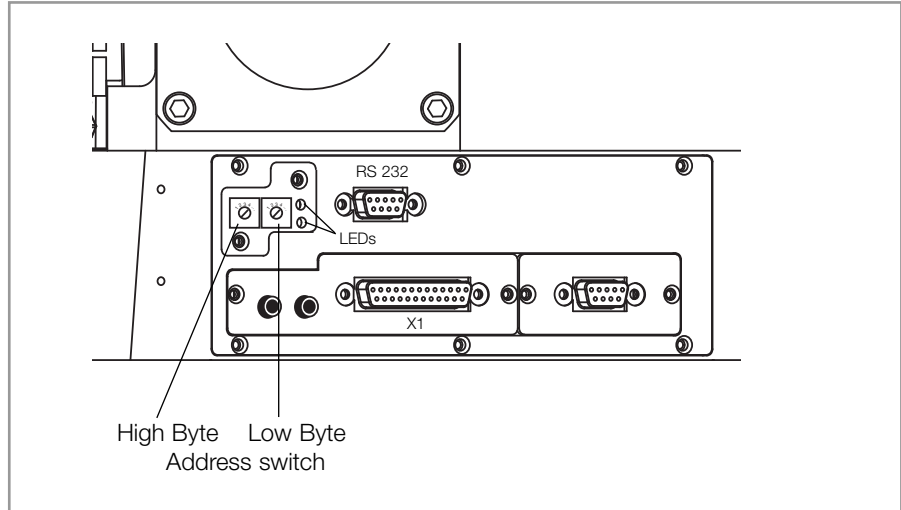


Fig. 4.8 Setting up the slave address

The baud rate is adjusted automatically. No parameter or switch needs to be set.

Extended user parameter data are not required.

The sync. mode and the freeze mode are supported.

Slave address

The slave address is set up through two address switches; see Fig. 4.8. These address switches may be accessed after removing the transparent Plexiglas cover. After having set up the address, fit the Plexiglas cover once more so as to maintain the IP 54 protection rating specified for the pump.

The address switches are set according to hexadecimal codes resulting in a range from 03_{hex} to $7E_{\text{hex}}$ ($7E_{\text{hex}} = 126_{\text{dec}}$).

The address which has been set up will only become effective after switching the unit on.

Configuration (PPO types)

For the TURBOVAC, several different protocol types (PPO types) have been implemented.

PPO type 1

Number of input and output data 6 words each = 12 byte

Identifier = 0xF3, 0xF1 (net. data assignment see VDI/VDE standard 3689, page 29).

For the way in which the control and status words are assigned in accordance with VDI/VDE standard 3689 page 14 to page 16; see Fig. 4.9 and 4.10.

Byte 0	Parameter order or reply and 3 most significant bits of the parameter number
Byte 1	Parameter number (Low byte)
Byte 2	Parameter index for error data (P171 ... P174, otherwise always 0)
Byte 3	Not used
Byte 4 to 7	Parameter value (high low)
Byte 8 and 9	Control and status word, same as for PPO type 6
Byte 10 and 11	Setpoint or actual value (target speed; bit 6 of the control word must be set to „1“).

In the case of the word definition, the high byte is transmitted first (Motorola standard).

Interfaces

PPO type 6

Number of input and output data 1word each = 2 byte

Identifier = 0x00, 0xF0 (1 control word + 1 status word).

Control word for TURBOVAC

Bit	
0	*Start/Stop pump
1, 2, 3, 4, 5	Not used
6	*Enable set point —(enable the principal setpoint (speed) in the case of PPO type 1; set always to „0“ in the case of PPO type 6)
7	*Acknowledge error
8	*Standby speed
9	Not used
10	Enable process data (bit 0, 6, 7, 8, 11, 12)
11	*Purge gas ON
12	*Venting ON
13/14/15	Not used

* In order to activate the control function through the Profibus interface, **bit 10 must be set in the case of PPO types 1 or 6**. Control via the control connector X1 or via the push-buttons is then disabled.

Status word from the TURBOVAC

Bit	
0	Ready to switch on
1	Always 0
2	Operation enabled — (converter active)
3	Error active
4	Not used
5	Not used
6	Switch on lock
7	Temperature warning
8	Not used
9	Not used
10	Normal operation
11	Pump is running (speed over 3 Hz)
12	Maintenance is required
13	Overload warning
14	Not used
15	Not used

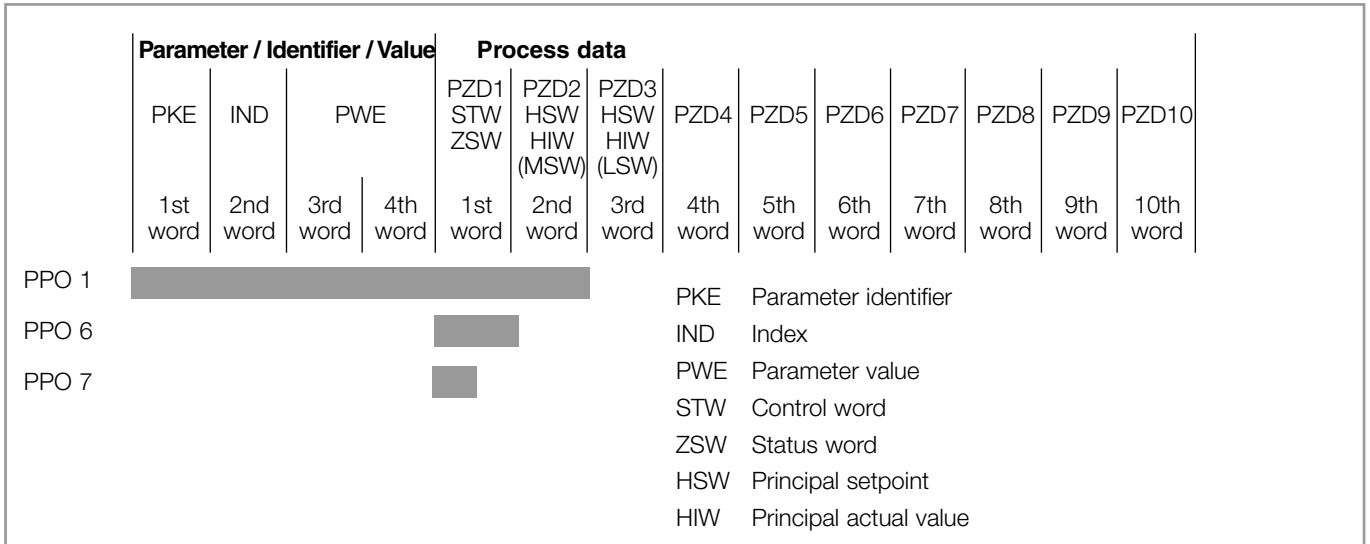


Fig. 4.9 Parameter process data object (PPO Types)

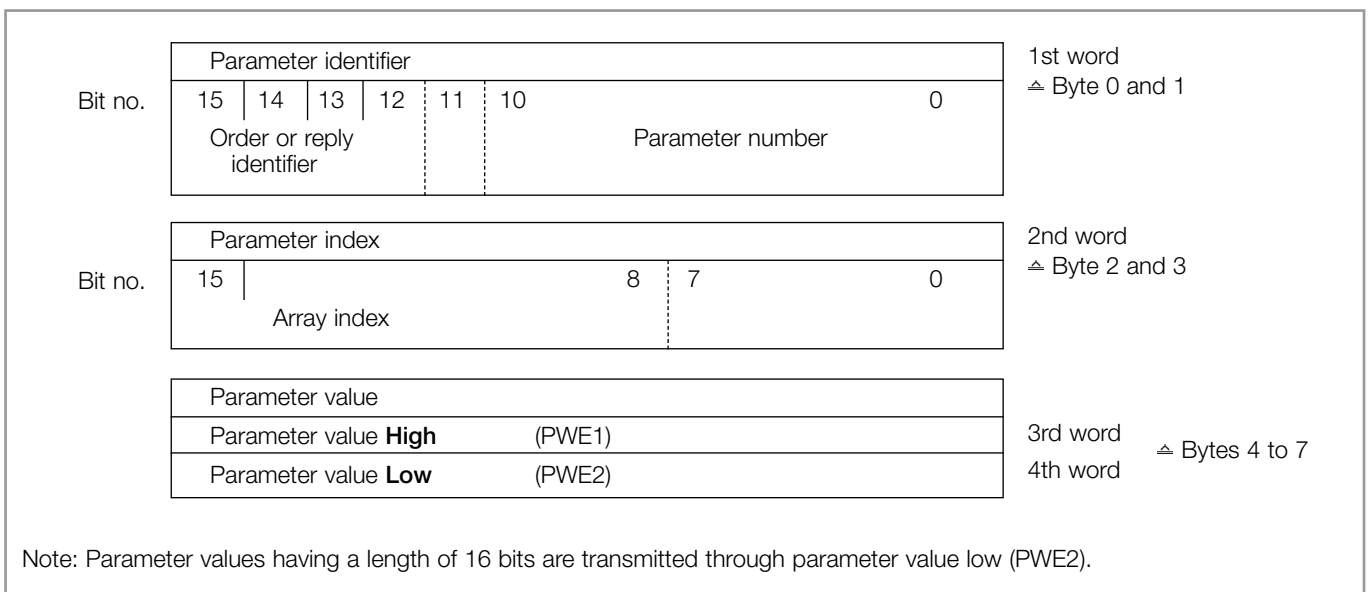


Fig. 4.10 Structure of the parameter range (PKW = parameter identifier value)

PPO type 7

Number of input and output data 1 byte each

Identifier = 0x00, 0xB0 (1 control byte and 1 status byte)

Control byte for the TURBOVAC

Bit	
0	*Start/Stop pump
1	Not used
2	Enable process data (bit 0, 4, 5, 6 and 7)
3	Not used
4	*Purge gas ON
5	*Venting ON
6	*Go to standby speed
7	*Acknowledge error

Status byte from the TURBOVAC

Bit	
0	Normal operation has been attained
1	Pump is running (speed over 3 Hz)
2	Maintenance is required
3	Error active
4	Not used
5	Not used
6	Overload warning
7	Temperature warning

* In order to activate the control function through the Profibus interface, **bit 2 must be set** in the case of PPO type 7. Control via the control connector X1 or via the push-buttons is then disabled.

Parameter range (PKW)

Through the PKW feature it is possible to process the following:

- Operation and observation of parameters (write/read)
- Transmission and acknowledgement of spontaneous messages

The parameter range always comprises 4 words; see Fig. 4.10.

Parameter identifier (PKE) (1st word)

The parameter identifier (PKE) is always a 16 bit value. The bits 0 to 10 (PNU) contain the number of the desired parameter. For the meaning of each parameter see list of parameters.

Bit 11 = 0 (reserved)

Bits 12 to 15 (AK) contain the order or reply identifier.

Meaning of the order identifier for the order message (master → main electronics or converter)

Order identifier	Meaning	Reply identifier	
		positive	negative
0	No order	0	7 or 8
1	Query parameter value	1 or 2	7 or 8
2	Change parameter value (word)	1	7 or 8
3	Change parameter value (double word)	2	7 or 8
4	Query descriptive element ¹⁾ (not for 181 35)	3	7 or 8
5	Change descriptive element (not for 181 35)	3	7 or 8
6	Query parameter value (array) ²⁾	4 or 5	7 or 8
7	Change parameter value (array, word) ²⁾	4	7 or 8
8	Change parameter value (array, double word) ²⁾	5	7 or 8
9	Query number of array elements	6	7 or 8
10			
11			
12			
13			
14			
15			

Interfaces

Meaning of the order identifier for the reply message (main electronics or converter → master)

Reply identifier	Meaning
0	No reply
1	Transmit parameter value (word)
2	Transmit parameter value (double word)
3	Transmit descriptive element ¹⁾
4	Transmit parameter value (array, word) ²⁾
5	Transmit parameter value (array, double word) ²⁾
6	Transmit number of array elements
7	Order can not be executed (with error number)
8	Not authorised for PKW interface
9	
10	
11	
12	
13	
14	
15	

Depending on the order identifier only certain reply identifiers are possible. If the reply identifier has a value of 7 (order can not be executed), then an error number will be available under parameter value 2 (PWE 2).

Parameter index IND (2nd word)

The index complies to the Profibus standard VDI/VDE 3689.

¹⁾ The desired element of the parameter description is stated in IND (2nd word).

²⁾ The desired element of the indexed parameter is stated in IND (2nd word).

Parameter list

No.	Designation	Range	Unit	Default	Type	Access
0	Not used	-	-	0	-	
1	Unit identifier	100 - 102	-	102	u16	r
2	Software version	02.01.01 - 6.55.35	0.00.00	2.03.16	u16	r
3	Actual value of the frequency	0 - 510	Hz	0	u16	r
4	Intermediate circuit voltage Uz _k	0 - 100.0	0.1 V	591	u16	r
5	Actual value of the motor current	0 - 100.0	0.1 A	0	u16	r
6	Power	0 - 6553.5	0.1 W	0	u16	r
7	Actual value of the motor temperature	0 - 250	°C	23	s16	r
11	Actual value of the converter temperature	0 - 100	°C	29	s16	r
12	Operating mode 0 = Key pad or control connector 1 = Serial interface 2 = Serial interface and STOP push-button	0 - 2	-	0	3 Bits	r/w
13	Remote/local 0 = Local (key pad) 1 = Remote (control connector)	0 - 1	-	0	1 Bit	r
16	Warning temperature for the motor	0 - P133	°C	80	u16	r
17	Nominal current for the motor	0 - 31.9	0.1 A	80	u16	r
18	Nominal frequency	0 - 500	Hz	500	u16	r
19	Minimum frequency	P20 - P18	Hz	300	u16	r
20	Frequency threshold for run-up until minimum frequency; shutdown frequency at overload	0 - P19	Hz	280	u16	r
21	Motor current threshold: is checked after P32 seconds for P17 x P12; in case the current is exceeded: overload warning	1 - 100	%	73 for T 1600/T 1601 100 for TW 1600	u16	r
22	Run-up time until shut down frequency (P20)	0 - P32	s	450 for T 1600/T 1601 420 for TW 1600	u16	r
23	Pump model (T 1600 = 20)	20 - 30	-	20/21	u16	r
24	Setpoint frequency	P19 - P18	Hz	500	u16	r/w
25	Nominal operating factor of the setpoint frequency P24 but > P20	35 - 99	%	95	u16	r/w
30	Mode for the analogue output 0 = Bearing temperature, top 1 = Bearing temperature, bottom 2 = Motor current 3 = Frequency	0 - 3	-	0	u16	r/w
31	Ranging S factor for the analogue output 1.0	0 - 2.0	0.1	10	u16	r/w

Interfaces

No.	Designation	Range	Unit	Default	Type	Access
32	Max. run-up time; max. overload time	600 - 3600	s	800 for T 1600/T 1601 720 for TW 1600	u16	r/w
34	General status; Bit 0: bearing change	0 - 65535	-	0	u16	r
36	Start delay time	0 - 1200	s	-	u16	r/w
38	Number of start bits	0 - 65535	-	-	u16	r
40	Number of all errors	0 - 65535	-	-	u16	r
41	Number of errors relating to overloads	0 - 65535	-	-	u16	r
42	Number of errors relating to motor temp.	0 - 65535	-	-	u16	r
43	Number of errors relating to mains failures	0 - 65535	-	-	u16	r
44	Number of operating hours for the pump	0 - 167772.16	0.01 h	-	u32	r
50	Part No. of the pump	0 - 16777216	-	-	u32	r
52	Serial number of the pump	0 - 16777216	-	-	u32	r
54	Manufacturing date	0 - 1677.72.16	0.00.00	-	u32	r
56	Service date	0 - 1677.72.16	0.00.00	-	u32	r
58	Service identifier	0 - 16777216	-	0	u32	r
60	Operating hours counter at last maintenance	0 - 167772.16	0.01 h	0	u32	r
62	Repair date	0 - 1677.72.16	0.00.00	-	u32	r
64	Repair identifier	0 - 16777216	-	0	u32	r
66	Operating hours since last repair	0 - 167772.16	0.01 h	0	u32	r
72	Inspector identifier	0 - 16777216	-	-	u32	r
84	Serial number for the converter	0 - 65535	-	-	u16	r
85	Serial number for the power supply unit	0 - 65535	-	-	u16	r
86	Option converter 1	0 - 65535	-	0	u16	r
87	Option converter 2	0 - 65535	-	-	u16	r
125	Bearing temperature top, actual value	0 - 100	°C	21	u16	r
126	Warning temperature bearing top	0 - P131	°C	70	u16	r
127	Bearing temperature bottom, actual value	0 - 100	°C	23	u16	r
128	Warning temperature bearing bottom	0 - P132	°C	65	u16	r
131	Shut down temperature bearing top	0 - 100	°C	75	u16	r
132	Shut down temperature bearing bottom	0 - 100	°C	70	u16	r
133	Shut down temperature motor	0 - 140	°C	100	u16	r

No.	Designation	Range	Unit	Default	Type	Access
150	Standby speed	P20 - P24	Hz	350	u16	r/w
151	Enable standby 0 = Normal operation 1 = Standby speed	0 - 1	-	0	u16	r/w
152	Acknowledge maintenance of moving parts Write „1“ and reset to „0“ within 1 minute	0 - 1	-	-	u16	r
153	Acknowledge bearing exchange Write „1“ and reset to „0“ within 1 minute	0 - 1	-	-	u16	r
160	Set clock: Write „1“ and reset to „0“	0 - 1	-	0	u16	r
161	Real time seconds	0 - 59	-	-	u16	r
162	Real time minutes	0 - 59	-	-	u16	r
163	Real time hours	0 - 23	-	-	u16	r
164	Real time days	1 - 31	-	-	u16	r
165	Real time months	1 - 12	-	-	u16	r
166	Real time years	1991 - 2089	-	-	u16	r
167	Real time clock	0 - 2359	-	-	u16	r
168	Real time date	01.01.00 - 31.12.99	-	-	u32	r
171	Error number (0..39) See Section "Error Memory"	0 - 55	-	-	u16	r
172	Error date (0..39) See Section "Error Memory"	0 - 31.12.99	-	-	u32	r
173	Error time (0..39) See Section "Error Memory"	0 - 23.59	-	-	u16	r
174	Error frequency (0..39) See Section "Error Memory"	0 - 510	Hz	-	u16	r
227	Warning_bits1 See Section "Error Memory"	0 - 65535	-	-	s16	r
228	Warning_bits2; reserved	0 - 65535	-	-	s16	r
918	Active Profibus address	3 - 126	-	-		
947	Current error number	0 - 55	-	0		
967	Control word (USS, Profibus)	-	-	-		
968	Status word (USS, Profibus)	-	-	-		

Access: r: read only; r/w: read and write

Interfaces

Error memory

No.	Description	Shut down	Remark/Condition (P = parameter)
0	No error	—	
1	Overload (load limit has been exceeded)	no	$P3 < P25 \times P24$
2	Motor temperature too high	yes	$P7 > P133$
3	A mains failure has occurred	no	Mains failure during pump operation
4	Converter temperature too high	yes	$P11 > 74 \text{ °C}$
5	The pump has been running at overspeed	no	$P3 > (P24 + 10 \text{ Hz})$
6	Speed has fallen below shutdown frequency threshold at overload	yes	$P20 > P3$
7	Max. run-up time has been exceeded	yes	$(P3 > P25 \times P24)$ not reached in P32
8	Error in the communication identifying the pump	yes	Internal electronic error
9	Temperature at bearing 1 top too high	yes	$P125 > P131$
10	Temperature at bearing 2 bottom too high	yes	$P127 > P132$
16	Max. overload time has been exceeded	yes	$(P3 < P25 \times P24)$ for longer than P32
17	No motor current	yes	
19	Run-up time exceeded	yes	P20 not reached in P22
25	Overload operation	no	$P5 > P17 \times P21$
26	Short circuit in the temperature sensor for the top bearing	yes	$P125 < 1 \text{ °C}$
27	Short circuit in the temperature sensor for the bottom bearing	yes	$P127 < 1 \text{ °C}$
28	Short circuit in the temperature sensor for the motor	yes	$P7 < 1 \text{ °C}$
29	Maintenance of moving parts is required	no	The TURBOVAC will indicate this warning every 48,000 operating hours. This maintenance can only be done by Oerlikon Leybold Vacuum Service.
31	Max. overload time has been exceeded	yes	$P5 > P17 \times P21$ for longer than $2 \times P32$
43 to 55	Internal error	yes	If you experience one of the error codes 43 to 55, you should check operation of the TURBOVAC for safety reasons. Please contact us in such a case.

Real time clock - error memory

In pump memory block 8, the past 40 errors are saved (ring counter). This block contains 8 bytes indicating the following (sequence MSB → LSB)

The parameter 171 (with index 0 to 39) contains the error number; see Section „Error memory“.

The parameter 172 (with index 0 to 39) contains the date of the error (day, month, year) in **decimal code** (140201 indicates Feb. 14 (20)01).

The parameter 173 (with index 0 to 39) contains the time of the error (hour, minute) in **decimal code** (1345 is 13.45 hours).

Processing of the data relating to the internal clock is ensured until the year 2090.

The parameter 174 (with index 0 to 39) contains the frequency at which the error occurred.

If one of the parameters 171 to 174 under an index is queried for the first time, the data for this index need to be requested from the pump's memory first. This results in slight delay for the first access. All further accessing to this index is performed at full speed until there are new entries in the error memory.

Warnings relating to parameters

The parameter 227 (Warning_bits 1) has been assigned as follows:

P227

Bit	Meaning	Remark
0	Motor temperature*	if P7 > P16
1	Converter temperature*	if P11 > 64
2	Temperature bearing 1 (top)*	if P125 > P126
3	Temperature bearing 2 (bottom)*	if P127 > P128
4	—	not used
5	PK communication	read or write
6	Overspeed	if P3 > (P24 + 10 Hz)
7	—	not used
8	Overload	P32 seconds after starting if P5 > (P17 x P21)
9	Maintenance for moving parts	if P44 > (P60+48000h)
10	Bearing change (Bearing temperature warning)	if P127 – P125 > 10 °C or P125 – P127 > 6 °C

* The temperatures stated are the upper warning levels. For the warning to be erased, the temperatures need to be reduced by 10%.

Interfaces

Acknowledging errors

An error can only be acknowledged if

- the cause for the error no longer persists (for example because the pump has cooled down)
- the frequency of the pump has dropped below 25 Hz and
- no Start command is present.

Checklist: Control the pump via Profibus

- Profibus connected correctly?
- Profibus address set?
- Correct GSD file used? (Annex)
- Profibus slave “pump” integrated correctly?
- Bit “Enable process data” set (Bit 10 at PPO Type 1 or 6, Bit 2 at PPO Type 7) in order to activate the control function through the Profibus interface?
- Start or stop the pump by setting or resetting Bit 0 in the control word!

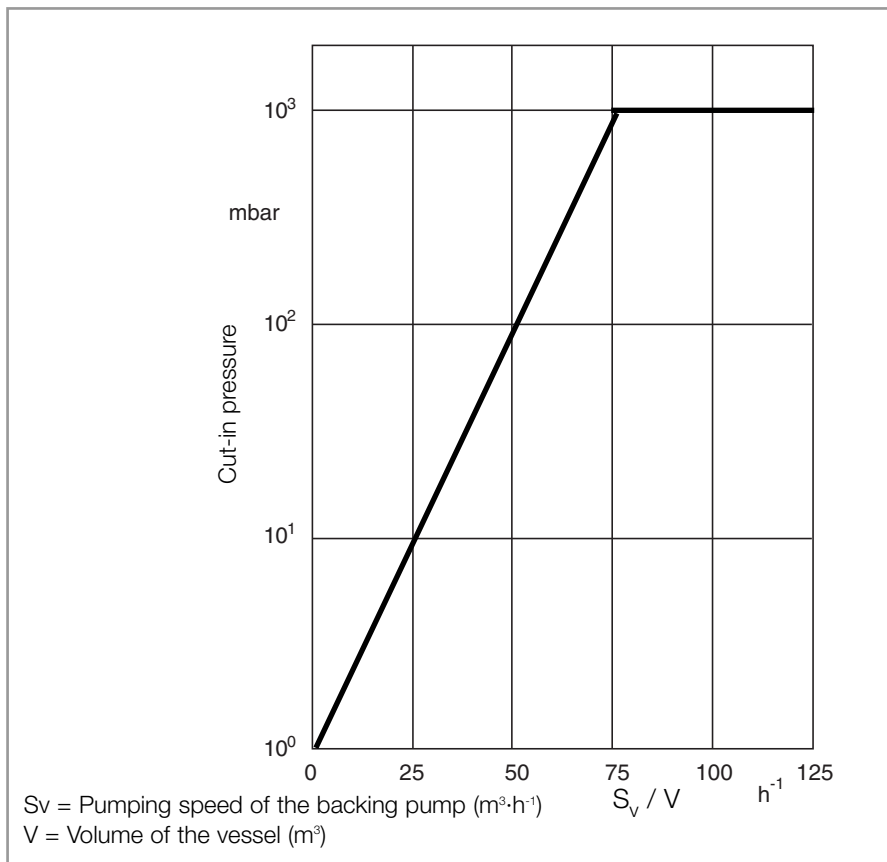


Fig. 4.11 Determining the cut-in pressure for a TURBOVAC when evacuating large volumes

4.4 Switching on

Open the cooling water and purge gas supplies.

Large vessels must first be evacuated by the backing pump or a backing pump system.

In the case of smaller vessels the cut-in pressure for the TURBOVAC may be taken from Fig. 4.11.

If $S_v / V > 75$ [h^{-1}] then both TURBOVAC and the backing pump may be switched on simultaneously.

Operate the START push-button or start the pump via the interface.

Avoid the influences of shock and vibration when the pump is running.

Exposure of the pump to accelerating forces must be avoided or reduced to such an extent that the rotor unit will not be excited by vibrations. In the case of critical applications you must consult our Applications Dept. first.

Starting pressure

NOTICE



Operation

4.5 Shutting down

Operate the STOP push-button or switch the pump off via its interface.

Venting

In order to avoid any damaging back-diffusion of aggressive gases or particles the pump should be vented after shut-down.

When the system is not operating, ensure that neither ambient air nor cleaning media can enter the pump.

Formation of condensate

Immediately after switching off the TURBOVAC also shut off the cooling water supply so as to prevent the formation of condensate by the pump.

4.6 Venting

Refer to Section 4.1 for suited gases.

Venting methods

There are three different methods of venting the turbomolecular pump.

In the case processes requiring a purge gas, the pump must be vented via the **purge gas and venting valve** when shutting the pump down.

When additionally venting the vacuum chamber, the venting function of the purge gas and venting valve must be opened before opening the chamber valve. This will ensure the presence of a higher pressure in the area of the ball bearings compared to the remaining vacuum area. This will prevent particles, dust or aggressive gases from being forced through the bearings into the not yet vented motor chamber of the pump.

Cautious venting of the pump is possible from the **high vacuum side**, since here the bearing forces will be lowest. When doing so, no free jet of gas must be allowed to form on the rotor so as to avoid exposing the rotor to additional forces.

When venting the pump through its **foreline connection**, neither oil nor particles may be entrained in the gas flow from the forevacuum side into the pump.

Speed of the pressure rise

Speed Pressure rise curve

All turbomolecular pumps may be vented at full speed. However, the pressure must not increase faster than specified through the pressure rise curve.

Particles

The pump must be vented significantly slower when there is the risk of particles entering into the pump from the process. During venting, the flow must be of the laminar type in both the vacuum chamber and the turbomolecular pump.

The speed of the pressure rise during venting of the running pump will greatly influence the load on the rotor/stator pack and the bearings. The slower the pump is vented, the longer the service life of the bearings will be.

The pump must not be vented to pressures above atmospheric pressure.

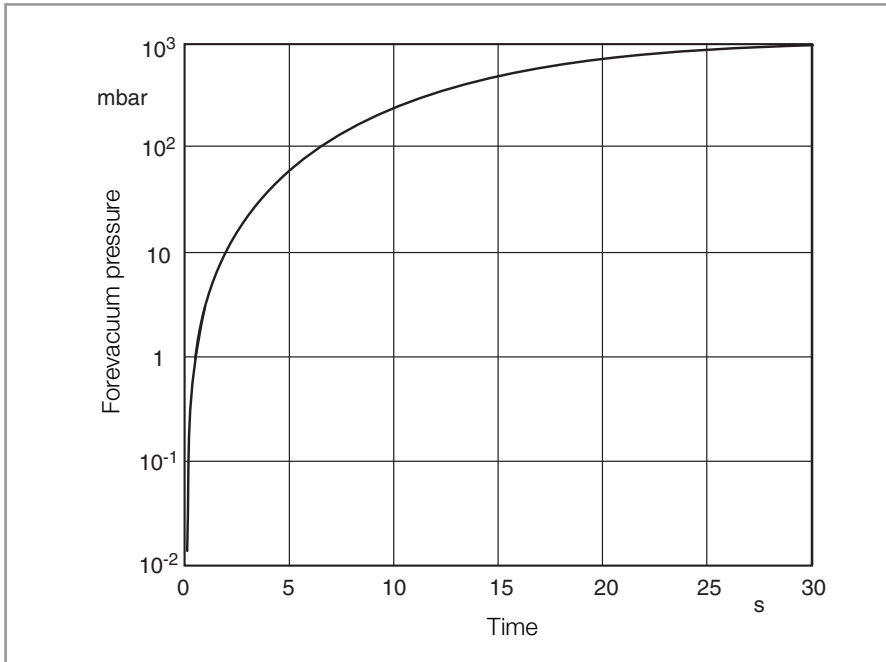


Fig. 4.12 Maximum rise in pressure

4.7 Bakeout

For TURBOVACs with CF flange

If pressures in the range of 10^{-8} mbar or below are to be developed, the vacuum chamber and the components installed therein will have to be baked out. In addition, the TURBOVAC can be baked out using the flange heater provided for this purpose.

Protect the rotor against intensive, direct heat radiation. When baking out at the forevacuum side – at a sorption trap, for example – ensure that the components attached direct are not heated to more than 100 °C (212 °F).

The forevacuum pump must be in operation so as to eliminate the vapors liberated at the sorption trap.

Operation

4.8 Removing the pump from the system

Shut down the pump and vent as described in Sections 4.5 and 4.6.



If the pump has previously handled hazardous gases, implement the proper precautionary measures before opening the intake or exhaust connection.

Observe Safety Informations 0.4.6.

If the pump previously handled corrosive gases, then allow the purge gas to flow for as long as possible before detaching the pump from the system.

Disconnect the pump only when it has come to a full stop.

Hazardous gases

The pumps may be contaminated with process gases. These gases may be toxic and hazardous to health. In addition, deposits with similarly dangerous properties may have formed. Many of these gases and deposits form acids when they come into contact with humid air. This will result in serious corrosion damage to the pump.

Deposits

Desiccant

To avoid health hazards and corrosion damage when the pumps are detached from the system, fasten a container of desiccant under the transport cover of the high-vacuum connection and then close the pump immediately at all flange connections. Store the pump, with a desiccant, in an airtight PE bag.

We recommend to use the seal kit for the TURBOVAC; Ref. no. see Section 1.3.

Corrosion damage due to faulty packing will nullify the guarantee.

Pack the pump so that it cannot be damaged during shipping and storage. Pay particular attention to protection for the flanges and the electrical plug.

Observe the instructions in Section 5.2 if you forward the pump to Oerlikon Leybold Vacuum.

5 Maintenance

We recommend a standard bearing exchange after 20 000 to 25 000 hours of operation.

We recommend to change the rotor after **80,000 hours of operation** or after **20,000 starts/ stops** or cycles at the latest.

Such maintenance works can only be done by the Oerlikon Leybold Vacuum Service. If required contact the Oerlikon Leybold Vacuum service center nearest to your location. You can find the address on our internet page www.oerlikon.com.

At high pump loads - for example during cyclic operation, at high gas throughputs or at high ambient temperatures - the aforementioned maintenance work should be carried forward. Please consult Oerlikon Leybold Vacuum for recommendations.

Observe Safety information 0.1.7.

Depending on the degree of contamination of the purge gas used the filter will clog and will have to be exchanged (our experience indicates that this will become necessary after 1 to 6 months).

When an adsorption trap is used, regenerate or renew the adsorption agent regularly; refer to the operating instructions provided with the trap.

5.1 Cleaning

If required clean the turbomolecular pump of dust with a dry cloth.

Cleaning the frequency converter internally

The converter essentially requires no servicing since it contains no components which could be adjusted.

Depending on the installation particulars and the ambient conditions, the converter may collect grime (dust, moisture) on the inside. Such contamination can lead to malfunctions, overheating or short circuits and will have to be avoided to the maximum extent possible. The Oerlikon Leybold Vacuum Service Department can clean the converter. We recommend adhering to a cleaning interval of about five years.

Standard bearing exchange

Rotor exchange

WARNING



Purge gas filter

Adsorption trap

Maintenance

5.2 Oerlikon Leybold Vacuum service

Contamination

Whenever you send us in equipment, indicate whether the equipment is contaminated or is free of substances which could pose a health hazard. If it is contaminated, specify exactly which substances are involved. You must use the form we have prepared for this purpose.

Form

A copy of the form has been reproduced at the end of these Operating Instructions: "Declaration of Contamination for Compressors, Vacuum Pumps and Components". Another suitable form is available from www.oerlikon.com → Oerlikon Leybold Vacuum → Documentation → Download Documents.

Attach the form to the equipment or enclose it with the equipment.

This statement detailing the type of contamination is required to satisfy legal requirements and for the protection of our employees.

We must return to the sender any equipment which is not accompanied by a contamination statement.

6 Troubleshooting

Fault	Possible cause	Remedy
TURBOVAC will not start.	Mains power has not been applied or is out of limit.	Check mains voltage and mains cord.
The message „Warning“ is indicated.	<p>The self test of the frequency converter which is run upon applying the mains power will indicate that maintenance is due.</p> <p>Upon applying the mains power it was found that the clock is faulty (possibly an exhausted battery).</p> <p>The temperature at one bearing is too high.</p> <p>The temperature of the motor is too high.</p> <p>Motor power of the pump is too great due to excessively high pressures or gas throughput.</p> <p>Because of excessive loading the pump is not able to maintain its nominal speed.</p>	<p>We recommend that you have the bearings exchanged after 20,000 to 25,000 operating hours and the rotor after 80,000 operating hours. Contact us for more information on this. The “warning” may be indicated after less operating hours; it may be ignored in this case.</p> <p>Contact Oerlikon Leybold Vacuum Service.</p> <p>Check the cooling water supply. Possibly plan with OLV an exchange of the bearings.</p> <p>Check loading of the pump and reduce the load to acceptable levels. Check cooling water supply.</p> <p>Check loading of the pump and reduce the load to acceptable levels. Check cooling water supply.</p> <p>Check loading of the pump and reduce the load to acceptable levels.</p>
The TURBOVAC shuts down with the message “Fault”.	<p>Internal electrical fault.</p> <p>The minimum speed was not attained within a certain time.</p> <p>Speed has dropped below the minimum.</p> <p>Pump was overloaded for quite some time.</p> <p>Motor or bearing temperatures have exceeded the limit.</p>	<p>Contact Oerlikon Leybold Vacuum Service.</p> <p>Check loading of the pump and reduce the load to acceptable levels.</p> <p>Check loading of the pump and reduce the load to acceptable levels.</p> <p>Check loading of the pump and reduce the load to acceptable levels. Contact OLV Service.</p> <p>Contact Oerlikon Leybold Vacuum Service.</p>
The TURBOVAC produces a lot of noise and vibrations.	<p>Unbalanced rotor.</p> <p>Failed bearing.</p> <p>Pump is running at the resonance frequency of the remaining system.</p>	<p>Balance the pump (OLV Service only).</p> <p>An exchange of the bearings is required (Oerlikon Leybold Vacuum Service only).</p> <p>Change the mass of the system or fit vibration absorbers for decoupling the vibrations.</p>

Troubleshooting

Fault	Possible cause	Remedy
The TURBO-VAC does not attain its ultimate pressure.	Faulty vacuum gauge. Contaminated gauge head. Leak in the system, lines or the pump. Contaminated pump. Backing pump system does not provide enough pumping speed or its base pressure is too high. Forevacuum pressure is too high. Quantity of gas too great / leak in the system.	Check the vacuum gauge. Clean the gauge head or replace it. Leak search. Have the pump cleaned (OLV Service only). Check ultimate pressure of backing pump; if required install a larger backing pump system. Check the backing pump; if required install a larger backing pump system. Seal off the leak; if required install a larger backing pump.
Pump cannot be controlled via Profibus or control is not reliable.	Profibus connected wrongly. Terminating resistor forgotten. Wrong bus cable used. High electromagnetic interference levels. Profibus address for the pump or for one of the pumps set wrongly. Wrong GSD file used. Profibus slave "pump" integrated wrongly. Bit "Enable process data" not set. Bit 0 in the control word not set or set wrongly. Connectors are corroded because they are not suitable or are not connected water-tight.	Connect Profibus correctly, see Fig. 4.7. Install terminating resistor. Use SIEMENS-SINEC-L2 bus cable. Connect the shield of the bus cables to the shield terminals. Set Profibus address correctly: 03 _{hex} to 7E _{Hex} . Use correct GSD file (Annex) Integrate Profibus slave "pump" correctly. Set bit "Enable process data" (Bit 10 at PPO Type 1 or 6, Bit 2 at PPO Type 7) in order to activate the control function through the Profibus interface. Start or stop the pump by setting or resetting Bit 0 in the control word. Connect the connectors in compliance with the required type of protection (IP 54 or IP 67), see Section 3.7.

7 Waste disposal

The equipment may have been contaminated by the process or by environmental influences. In this case the equipment must be decontaminated in accordance with the relevant regulations. We offer this service at fixed prices. Further details are available on request.

Contaminated parts can be detrimental to health and environment. Before beginning with any work, first find out whether any parts are contaminated. Adhere to the relevant regulations and take the necessary precautions when handling contaminated parts.

Separate clean components according to their materials, and dispose of these accordingly. We offer this service. Further details are available on request.

When sending us any equipment, observe the regulations given in Section "5.2 Oerlikon Leybold Vacuum service".

Contamination

WARNING



Our products comply with the requirements of the EC Machinery Directive (up to December 28, 2009: 98/37/EG, from December 29, 2009: 2006/42/EG) and fulfil the corresponding regulations laid down in the Low Voltage Directive (LVD) (2006/95/EG) und Electromagnetic Compatibility (EMC) Directive (2004/108/EG).

An Incorporation Declaration in accordance with the EC Machinery Directive (2006/42/EG) is provided on the next page.

Should you require a separate copy of the Incorporation Declaration with the current date, then please request it from documentation.vacuum@oerlikon.com.

In order to be able to send you the proper Incorporation Declaration, we require the part number and the serial number of the corresponding product as well as your full address.

You can contact our technical documentation officer – Mr. Herbert Etges – best through the following e-mail address documentation.vacuum@oerlikon.com .

Oerlikon Leybold Vacuum GmbH

Bonner Straße 498

D-50968 Köln

Tel.: +49-(0)221-347 1234

Fax: +49-(0)221-347 1245

documentation.vacuum@oerlikon.com

EC Incorporation Declaration

The manufacturer: Oerlikon Leybold Vacuum GmbH
Bonner Straße 498
D-50968 Cologne
Germany
Tel.: +49(0)221 347-0
email@oerlikon.com

herewith declares that the following product:

Product designation: **Turbomolecular pump**

Type designation:	P/N
TURBOVAC T1600	800040Vxxxx
TURBOVAC T1601	800040V4444
TURBOVAC TW1600	800041Vxxxx

x= 1 bis 9

complies with the following fundamental requirements of the **EC Machinery Directive (2006/42/EG)**:
Annex I, Paragraph 1.1.2, 1.1.3, 1.1.5, 1.2.1, 1.2.3, 1.2.4.1, 1.2.4.2, 1.2.6, 1.3.1, 1.3.2, 1.3.3, 1.3.4,
1.3.7, 1.5.1, 1.5.2, 1.5.4, 1.5.5, 1.5.13, 1.6.1 and 1.7.1

Moreover, the incomplete machine complies with all regulations laid down in the **Low Voltage Directive (LVD) (2006/95/EG)**.

The following harmonised standards have been applied:

EN 1012-2,	1996	Compressors and vacuum pumps - Safety requirements - Part 2: Vacuum pumps
EN 61010-1	2001	Safety requirements for electrical equipment for measurement, control, and laboratory use - Part 1: General requirements

The incomplete machine may only be put into operation after it has been determined that the machine into which the incomplete machine shall be installed complies with the regulations laid down in the EC Machinery Directive (2006/42/EG).

The manufacturer commits himself to make the special documentation on the incomplete machine electronically available to national authorities upon request.

The special engineering documentation belonging to the machine was compiled in accordance with Annex VII Part B.

Documentation Officer

Herbert Etges
Tel.: +49(0)221 347-0
Fax: + 49(0)221 347 1250
Documentation.vacuum@oerlikon.com
Oerlikon Leybold Vacuum GmbH
Bonner Straße 498 , D-50968 Cologne
Germany

Cologne, dated *2.10.09*

ppa h. Mattern-Klosson

Dr. Monika Mattern-Klosson
Head of Research & Development

Cologne, dated *02.10.09*

i.V. d. Udelhoven

Harald Udelhoven
Head of Quality Management



EC Declaration of Conformity

The manufacturer: Oerlikon Leybold Vacuum GmbH
Bonner Straße 498
D-50968 Cologne
Germany
Tel.: +49(0)221 347-0
email@oerlikon.com

herewith declares that the products specified and listed below which we have placed on the market, comply with the applicable EC Council Directives.

This declaration becomes invalid if modifications are made to the product without agreement of Oerlikon Leybold Vacuum GmbH.

Compliance with the EMC Directives requires that the components are installed within a system or machine in a manner adapted to EMC requirements.

Product designation: **Turbomolecular pump**

Type designation:	P/N
TURBOVAC T1600	800040Vxxxx
TURBOVAC T1601	800040V4444
TURBOVAC TW1600	800041Vxxxx

x= 1 bis 9

The product complies to the following European Council Directives:

EC-Directive relating to **electromagnetic compatibility (2004/108/EG)**.

The following harmonised standard has been applied:

EN 61326-1, 2006 Electrical equipment for measurement, control and laboratory use
— EMC requirements — Part 1: General requirements

Cologne, dated *2.10.09*

Cologne, dated *02.10.09*

ppa h. katten-kloss

Dr. Monika Mattern-Klosson
Head of Research & Development

i.v. b. ude

Harald Udelhoven
Head of Quality Management

300299320_002_A0 - 10/2009

A

accelerating forces 8, 49
address 4, 33, 36, 45, 48, 53, 56, 58, 64
adsorption trap 22, 26, 53
ambient temperature 11, 17, 24

B

backing pump 10, 16, 23, 49, 55
bakeout 51
baud rate 35, 36

C

compound stage 10
contamination 53, 54, 57
control connector 23, 25, 27, 28, 31, 38, 40, 43
cooling water 10, 11, 23, 24, 49, 50, 55
corrosion 6, 15, 17, 27, 52
crane eyes 15
cut-in pressure 49

D

deposits 6, 7, 16, 27, 52
desiccant 10, 15, 18, 52
dimensional drawings 14

E

error memory 45-47

F

fault 26, 30, 55, 56
filter 7, 10, 18, 20, 27, 53
forevacuum connection 2, 22
frequency converter 6, 8, 10, 16, 17, 26, 30, 33, 53, 55

H

hazardous gases 7, 22, 52
high-vacuum connection 10, 52
high-vacuum flange 18-20

I

ignition 8
inlet screen 8, 10, 19, 20

M

magnetic field 17
mains cord 10, 12, 25, 55
media 3, 7, 27, 50

N

normal operation 11, 30, 31, 32, 38, 40, 45

O

overpressure 5, 23
oxygen 16

P

particles 50
PE bag 10, 15, 52
PLC 29
pressure rise 50
protection 6, 11, 16, 19, 25, 28, 33, 34, 36, 52, 54, 56
pump's speed 32
purge gas 5, 7, 10, 11, 16, 18, 23, 25-27, 31, 38, 40, 49, 50, 52, 53
push-button 18, 26, 43, 49, 50

R

radiation 17, 51
relay 11, 29, 30, 31
remote control 18, 28, 29, 31
rotor exchange 53
RS 232 3, 12, 18, 31, 33, 36

S

seal kit 12, 52
shield 19, 28, 29, 31, 33, 35, 56
shocks 18
standard bearing exchange 53

T

torque 5, 7, 17, 19, 20, 21, 22

V

venting 19, 23, 26, 27, 31, 38, 40, 50
vibration 17, 19, 49, 55

W

water 6, 10, 11, 17, 18, 23, 24, 49, 50, 55, 56

Sales and Service

Germany

Oerlikon
Leybold Vacuum GmbH
Bonner Strasse 498
D-50968 Cologne
Phone: +49-(0)221-347 1234
Fax: +49-(0)221-347 1245
sales.vacuum@oerlikon.com
www.oerlikon.com

Oerlikon
Leybold Vacuum GmbH
Sales Area North/Northeast
Branch Office Berlin
Industriestrasse 10b
D-12099 Berlin
Phone: +49-(0)30-435 609 0
Fax: +49-(0)30-435 609 10
sales.vacuum.bn@oerlikon.com

Oerlikon
Leybold Vacuum GmbH
Sales Area South/Southwest
Branch Office Munich
Karl-Hammerschmidt-Strasse 34
D-85609 Aschheim-Dornach
Phone: +49-(0)89-357 33 9-10
Fax: +49-(0)89-357 33 9-33
sales.vacuum.mn@oerlikon.com
service.vacuum.mn@oerlikon.com

Oerlikon
Leybold Vacuum GmbH
Sales Area West & Benelux
Branch Office Cologne
Bonner Strasse 498
D-50968 Cologne
Phone: +49-(0)221-347 1270
Fax: +49-(0)221-347 1291
sales.vacuum.kn@oerlikon.com

Oerlikon
Leybold Vacuum GmbH
Service Competence Center
Emil-Hoffmann-Strasse 43
D-50996 Cologne-Suerth
Phone: +49-(0)221-347 1439
Fax: +49-(0)221-347 1945
service.vacuum.kn@oerlikon.com

Oerlikon
Leybold Vacuum GmbH
Mobil Customer Service
Emil-Hoffmann-Strasse 43
D-50996 Cologne-Suerth
Phone: +49-(0)221-347 1765
Fax: +49-(0)221-347 1944
service.vacuum.kn@oerlikon.com

Oerlikon
Leybold Vacuum
Dresden GmbH
Service Competence Center
Zur Wetterwarte 50, Haus 304
D-01109 Dresden
Service:
Phone: +49-(0)351-88 55 00
Fax: +49-(0)351-88 55 041
info.vacuum.dr@oerlikon.com

Oerlikon
Leybold Vacuum USA Inc.
5700 Mellon Road
USA-Export, PA 15632
Phone: +1-724-327-5700
Fax: +1-724-325-3577
info.vacuum.ex@oerlikon.com

Europe

Belgium
Oerlikon
Leybold Vacuum Nederland B.V.
Belgisch bijkantoor
Leuvensesteenweg 542-9A
B-1930 Zaventem
Sales:
Phone: +32-2-711 00 83
Fax: +32-2-720 83 38
sales.vacuum.zv@oerlikon.com
Service:
Phone: +32-2-711 00 82
Fax: +32-2-720 83 38
service.vacuum.zv@oerlikon.com

France
Oerlikon
Leybold Vacuum France S.A.
7, Avenue du Québec
Z.A. de Courtaboeuf 1 - B.P. 42
F-91942 Courtaboeuf Cedex
Sales and Service:
Phone: +33-1-69 82 48 00
Fax: +33-1-69 07 57 38
info.vacuum.ctb@oerlikon.com
sales.vacuum.ctb@oerlikon.com

Oerlikon
Leybold Vacuum France S.A.
Valence Factory
640, Rue A. Bergès
B.P. 107 640
F-26501 Bourg-lès-Valence Cedex
Service:
Phone: +33-4-75 82 33 00
Fax: +33-4-75 82 92 69
marketing.vacuum.vc@oerlikon.com

Great Britain
Oerlikon
Leybold Vacuum UK LTD.
Silverglade Business Park
Leatherhead Road Unit 2
KT9 2QL Chessington, Surrey
(London)
Sales:
Phone: +44-13-7273 7300
Fax: +44-13-7273 7301
sales.vacuum.ln@oerlikon.com
Service:
Phone: +44-20-8971 7030
Fax: +44-20-8971 7003
service.vacuum.ln@oerlikon.com

Italy
Oerlikon
Leybold Vacuum Italia S.r.l.
Via Trasimeno 8
I-20128 Milano
Sales:
Phone: +39-02-27 22 31
Fax: +39-02-27 20 96 41
sales.vacuum.mi@oerlikon.com
Service:
Phone: +39-02-27 22 31
Fax: +39-02-27 22 32 17
service.vacuum.mi@oerlikon.com

Netherlands
Oerlikon
Leybold Vacuum Nederland B.V.
Proostwetering 24N
NL-3543 AE Utrecht
Sales and Service:
Phone: +31-(30) 242 6330
Fax: +31-(30) 242 6331
sales.vacuum.ut@oerlikon.com
service.vacuum.ut@oerlikon.com

Spain
Oerlikon
Leybold Vacuum Spain, S.A.
C/ Huelva 7
E-08940 Cornellà de Llobregat
(Barcelona)
Sales:
Phone: +34-93-666 43 11
Fax: +34-93-666 43 70
sales.vacuum.ba@oerlikon.com
Service:
Phone: +34-93-666 46 16
Fax: +34-93-685 43 70
service.vacuum.ba@oerlikon.com

Sweden
Oerlikon
Leybold Vacuum Scandinavia AB
Box 9084
SE-40092 Göteborg
Sales and Service:
Phone: +46-31-68 84 70
Fax: +46-31-68 39 39
info.vacuum.gt@oerlikon.com
sales.vacuum.gt@oerlikon.com
Visiting/delivery address:
Datavägen 57B
SE-43632 Askim

Switzerland
Oerlikon
Leybold Vacuum Schweiz AG
Leutschenbachstrasse 55
CH-8050 Zürich
Sales:
Phone: +41-44-308 40 50
Fax: +41-44-302 43 73
sales.vacuum.zh@oerlikon.com
Service:
Phone: +41-44-308 40 62
Fax: +41-44-308 40 60
service.vacuum.zh@oerlikon.com

America

USA
Oerlikon
Leybold Vacuum USA Inc.
5700 Mellon Road
USA-Export, PA 15632
Phone: +1-724-327-5700
Fax: +1-724-325-3577
info.vacuum.ex@oerlikon.com
Sales:
Eastern & Central time zones
Phone: +1-724-327-5700
Fax: +1-724-333-1217
Pacific, Mountain, Alaskan &
Hawaiian time zones
Phone: +1-408-436-2828
Fax: +1-408-436-2849
Service:
Phone: +1-724-327-5700
Fax: +1-724-325-3577

Latin America
Oerlikon
Leybold Vacuum USA Inc.
Brazilian Office
Av. Dória 360 cj. 12 Campo Belo
04635-070 São Paulo SP BRAZIL
Sales:
Phone: +55 11-3554 3117
Fax: +55 11-3554 3117
nelson.batistucci@oerlikon.com

Oerlikon
Leybold Vacuum GmbH
Bonner Strasse 498
D-50968 Cologne
Phone: +49-(0)221-347 0
Fax: +49-(0)221-347 1250
info.vacuum@oerlikon.com

Asia

P.R. China
Oerlikon
Leybold Vacuum (Tianjin)
International Trade Co. Ltd.
Beichen Economic
Development Area (BEDA),
No.8 Western Shuangchen Road
Tianjin 300400
China
Sales and Service:
Phone: +86-22-2697 0808
Fax: +86-22-2697 4061
Fax: +86-22-2697 2017
info.vacuum.tj@oerlikon.com
sales.vacuum.tj@oerlikon.com
service.vacuum.tj@oerlikon.com

Oerlikon
Leybold Vacuum
(Tianjin) Co. Ltd.
Beichen Economic
Development Area (BEDA),
No.8 Western Shuangchen Road
Tianjin 300400
China
Sales and Service:
Phone: +86-22-2697 0808
Fax: +86-22-2697 4061
info.vacuum.tj@oerlikon.com
sales.vacuum.tj@oerlikon.com
service.vacuum.tj@oerlikon.com

Oerlikon
Leybold Vacuum (Tianjin)
International Trade Co. Ltd.
Shanghai Branch:
No.33
76 Fu Te Dong San Road
Waigaoqiao Free Trade Zone
Shanghai 200131
China
Sales and Service:
Phone: +86-21-5064-4666
Fax: +86-21-5064-4668
info.vacuum.sh@oerlikon.com
sales.vacuum.sh@oerlikon.com
service.vacuum.sh@oerlikon.com

Oerlikon
Leybold Vacuum (Tianjin)
International Trade Co. Ltd.
Guangzhou Office and
Service Center
1st F, Main Building
Science City Plaza,
No.111 Science Revenue,
Guangzhou Science City
(GZSC) 510663, Guangzhou,
China
Sales:
Phone: +86-20-223 23 980
Fax: +86-20-223 23 990
info.vacuum.gz@oerlikon.com
sales.vacuum.gz@oerlikon.com
service.vacuum.gz@oerlikon.com

Oerlikon
Leybold Vacuum (Tianjin)
International Trade Co. Ltd.
Beijing Branch:
1-908, Beijing Landmark Towers
8 North Dongsanhuan Road
Beijing 100004
China
Sales:
Phone: +86-10-6590-7622
Fax: +86-10-6590-7607
sales.vacuum.bj@oerlikon.com
service.vacuum.bj@oerlikon.com

India
Oerlikon
Leybold Vacuum India Pvt Ltd.
EL 22, J-Block
MIDC Bhosari
Pune 411026
India
Sales and Service:
Phone: +91-20-3061 6000
Fax: +91-20-2712 1571
sales.vacuum.pu@oerlikon.com
service.vacuum.pu@oerlikon.com

Japan
Oerlikon
Leybold Vacuum
Japan Co., Ltd.
Headquarter
23-3, Shin-Yokohama
3-chome
Tobu A.K. Bldg. 4th Floor
Kohoku-ku
Yokohama-shi 222-0033
Sales:
Phone: +81-45-471-3330
Fax: +81-45-471-3323
info.vacuum.yh@oerlikon.com
sales.vacuum.yh@oerlikon.com

Oerlikon
Leybold Vacuum
Japan Co., Ltd.
Osaka Sales Office
3F, Shin-Osaka Terasaki
No.3 Bldg.
1-5-28 Nishi-Miyahara
Yodogawa-ku, Osaka-shi
Osaka 532-0004
Phone: +81-6-6399-6271
Fax: +81-6-6399-6273
info.vacuum.os@oerlikon.com
sales.vacuum.os@oerlikon.com

Oerlikon
Leybold Vacuum
Japan Co., Ltd.
Tsukuba Technical Service Center
Kogyo Danchi
21, Kasuminosato,
Ami-machi, Inashiki-gun
Ibaraki-ken, 300-0315
Service:
Phone: +81-298 89 2841
Fax: +81-298 89 2838
info.vacuum.iik@oerlikon.com
sales.vacuum.iik@oerlikon.com

South Korea
Oerlikon
Leybold Vacuum Korea Ltd.
3F, Jellzone 2 Tower
Jeongja-dong 159-4
Bundang-gu Sungnam-si
Gyeonggi-do
Bundang 463-384, Korea
Sales:
Phone: +82-31 785 1367
Fax: +82-31 785 1359
sales.vacuum.bd@oerlikon.com

Service:
623-7, Upsung-Dong
Cheonan-Si
Chungcheongnam-Do
Korea 330-290
Phone: +82-41 589 3035
Fax: +82-41 588 0166
service.vacuum.cn@oerlikon.com

Singapore
Oerlikon
Leybold Vacuum
Singapore Pte Ltd.
1 Science Park Road
Singapore Science Park 2
#02-12, Capricorn Building
Singapore 117528
Sales and Service:
Phone: +65-6303 7000
Fax: +65-6773 0039
sales.vacuum.sg@oerlikon.com
service.vacuum.sg@oerlikon.com

Taiwan
Oerlikon
Leybold Vacuum Taiwan Ltd.
No 416-1, Sec. 3
Chungshin Road., Chutung
Hsinchu County 310
Taiwan, R.O.C.
Sales and Service:
Phone: +886-3-500 1688
Fax: +886-3-583 3999
sales.vacuum.hc@oerlikon.com
service.vacuum.hc@oerlikon.com

oerlikon
leybold vacuum
www.oerlikon.com/
leyboldvacuum