

SPARE PARTS CATALOGUE

Valvola mixproof

model: B925

code: BCW*****

serial: MPF

period approx: from 02/2006 to...

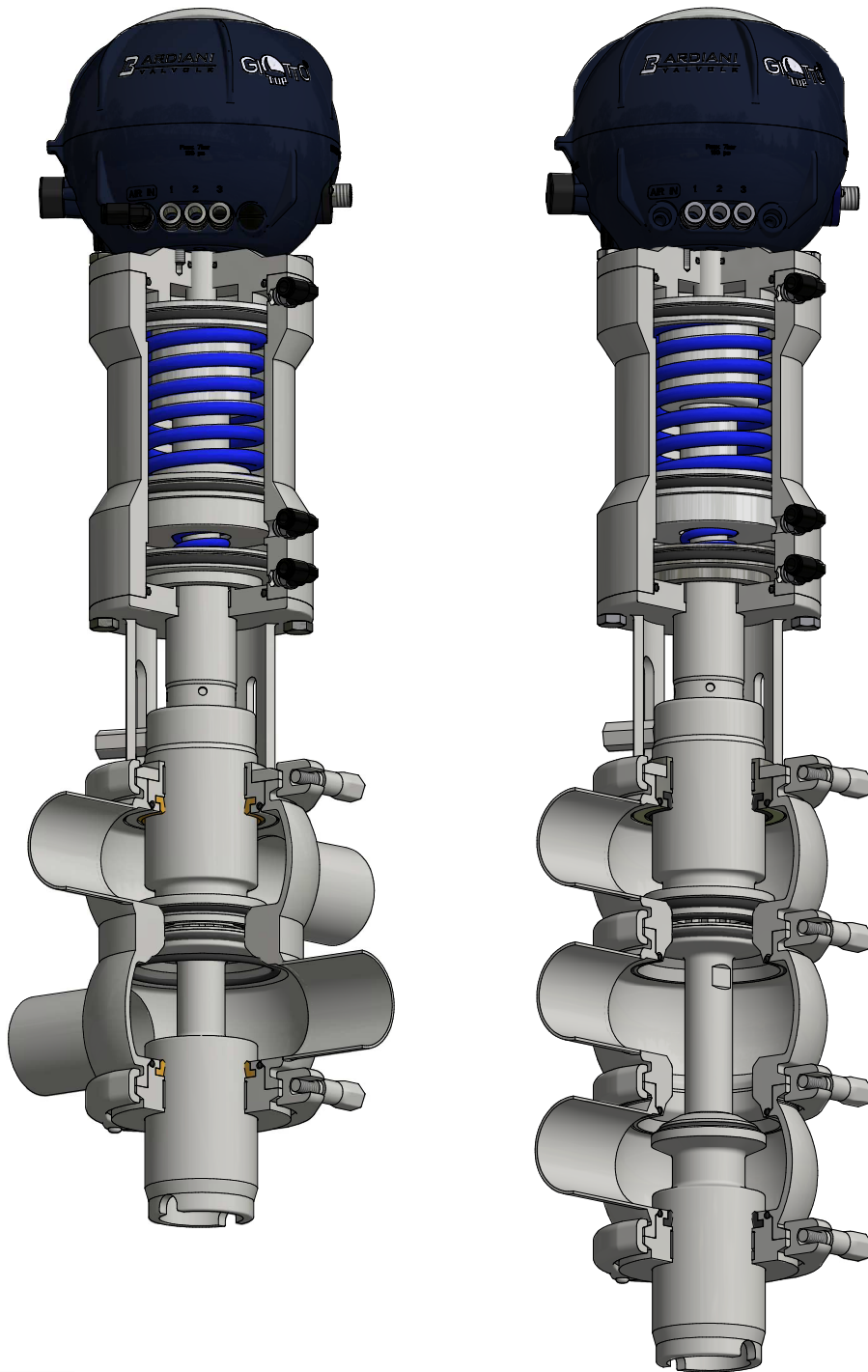

model: B925 DN:25 - - 150
gaskets material: EPDM/VIT

valve bodies: LL-TT-LT-TL

welding ends
actuator: SE

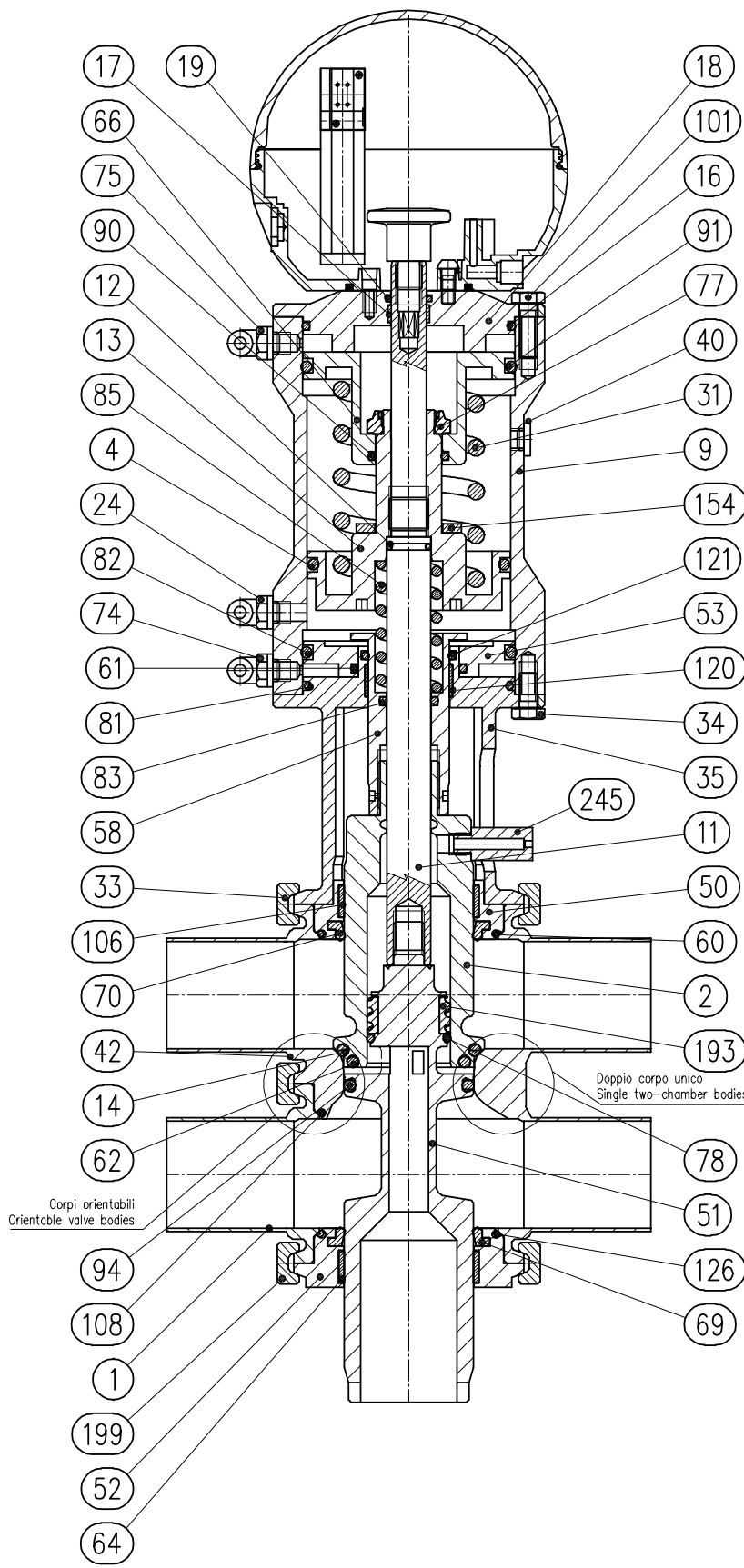

245	Perno guida/Pin guide
199	Morsetto/Clamp
193	Boccola/Guide bushing
154	Spessore/Gauge
126	Anello di tenuta/Seal ring
121	Anello di tenuta/Seal ring
120	Boccola/Guide bushing
108	Anello di tenuta/Seal ring
106	Boccola/Guide bushing
101	Vite/Socket screw
94	Anello di tenuta/Seal ring
91	Anello di tenuta/Seal ring
90	Anello di tenuta/Seal ring
85	Molla secondaria/Secondary spring
83	Anello di tenuta/Seal ring
82	Anello di tenuta/Seal ring
81	Anello di tenuta/Seal ring
78	Anello di tenuta/Seal ring
77	Dado/Nut
75	Raccordo aria/Lower connectios
74	Raccordo Aria/Lower connection
70	Anello di tenuta/Seal ring
69	Anello di tenuta/Seal ring
66	Pistone superiore/Piston upper
64	Boccola/Guide Bushing
62	Anello di tenuta/Seal ring
61	Anello di tenuta/Seal ring
60	Anello di tenuta/Seal ring
58	Manicotto di trascinamento/Adjusting sleeve
53	Pistone inferiore/Piston lower
52	Tappo/Plug
51	Otturatore inferiore/Shutter lower
50	Disco portatenuta/Cap
42	Corpo superiore/Body upper
40	Tappo/Plug
35	Assemblaggio/Part assembling
34	Vite/Socket scew
33	Morsetto/Clamp
31	Molla/Spring
24	Raccordo aria/Lower connection
19	Anello di tenuta/Seal ring
18	Tampone/Stopper
17	Boccola/Guide bushing
16	Anello di tenuta/Seal ring
14	Anello di tenuta/Seal ring
13	Pistone centrale/Piston main
12	Anello di tenuta/Seal ring
11	Perno/Pin
9	Cilindro/Cylinder
4	Anello di tenuta/Seal ring
2	Otturatore superiore/Shutter upper
1	Corpo inferiore/Body lower
Pos.	Descrizione

model: B925 DN:25 - - 100
gaskets material: EPDM/VIT

valve bodies: LL-TT-LT-TL

welding ends
actuator: SE

Pos.	Q.ty	Description	DN25-25.4	DN32	DN40-38.1	DN50-50.8	DN65-63.5	DN80-76.1	DN100-101.6
1	1	Lower body DIN "L"	TSA000025BBA	TSA000032BBA	TSA000040BBA	TSA000050BBA	TSA000065BBA	TSA000080BBA	TSA000100BBA
1	1	Lower body DIN "T"	TSA100025BBA	TSA100032BBA	TSA100040BBA	TSA100050BBA	TSA100065BBA	TSA100080BBA	TSA100100BBA
1	1	Lower body SMS "L"	TSA050100BBA		TSA050112BBA	TSA050200BBA	TSA050212BBA	TSA050300BBA	TSA000100BBA
1	1	Lower body SMS "T"	TSA150100BBA		TSA150112BBA	TSA150200BBA	TSA150212BBA	TSA150300BBA	TSA100100BBA
2	1	Upper shutter	TPA100040BBA	TPA100040BBA	TPA100040BBA	TPA100050BBA	TPA100065BBA	TPA100080BBA	TPA100100BBA
4	1	Seal ring	RAAGA6325	RAAGA6325	RAAGA6325	RAAGA6325	RAAGA6412	RAAGA6412	RAAGA204
9	1	Cylinder	TNC100093AAA	TNC100093AAA	TNC100093AAA	TNC100093AAA	TNC100115AAA	TNC100115AAA	TNC100138AAA
11	1	Pin	TNG100093AAA	TNG100093AAA	TNG100093AAA	TNG100093AAA	TNG100115AAA	TNG100115AAA	TNG100138AAA
12	1	Seal ring	RAAGA119	RAAGA119	RAAGA119	RAAGA119	RAAGA119	RAAGA119	RAAGA3087
13	1	Main piston	TNE100093LAA	TNE100093LAA	TNE100093LAA	TNE100093LAA	TNE100115LAB	TNE100115LAB	TNE100138LAA
14	1	Seal ring EPDM	TPJGM03806	TPJGM03806	TPJGM03806	TPJGM05106	TPJGM06506	TPJGM07406	TPJGM09706
14	1	Seal ring VIT	TPJGD03806	TPJGD03806	TPJGD03806	TPJGD05106	TPJGD06506	TPJGD07406	TPJGD09706
16	1	Seal ring	RAAGA4350	RAAGA4350	RAAGA4350	RAAGA4350	RAAGA4437	RAAGA4437	RAAGA4525
17	1	Guide bushing	TOJTE01615	TOJTE01615	TOJTE01615	TOJTE01615	TOJTE01615	TOJTE01615	TOJTE01615
18	1	Stopper cylinder	TNA100093AAA	TNA100093AAA	TNA100093AAA	TNA100093AAA	TNA100115AAA	TNA100115AAA	TNA100138AAA
19	1	Seal ring	RAAGA121	RAAGA121	RAAGA121	RAAGA121	RAAGA121	RAAGA121	RAAGA121
24	1	Air connector	RCSOA118	RCSOA118	RCSOA118	RCSOA118	RCSOA118	RCSOA118	RCSOA118
31	1	Spring	TNS070220FZA	TNS070220FZA	TNS070220FZA	TNS070220FZA	TNS090210FZA	TNS090210FZA	TNS120240FZA
33	2	Clamp	TOH000090AAA	TOH000090AAA	TOH000090AAA	TOH000105AAA	TOH000119AAA	TOH000130AAA	TOH000155AAA
34	4	Socket screw	RBAAA08X16	RBAAA08X16	RBAAA08X16	RBAAA08X16	RBAAA08X16	RBAAA08X16	RBAAA08X16
35	1	Part assembling	TOA100040AAA	TOA100040AAA	TOA100040AAA	TOA100050AAA	TOA100065AAB	TOA100080AAB	TOA100100AAA
40	1	Plug	RCS001PSA	RCS001PSA	RCS001PSA	RCS001PSA	RCS001PSA	RCS001PSA	RCS001PSA
42	1	Upper body DIN "L"	TSE000025BBA	TSE000032BBA	TSE000040BBA	TSE000050BBA	TSE000065BBA	TSE000080BBA	TSE000100BBA
42	1	Upper body DIN "T"	TSE100025BBA	TSE100032BBA	TSE100040BBA	TSE100050BBA	TSE100065BBA	TSE100080BBA	TSE100100BBA
42	1	Upper body SMS "L"	TSE050100BBA		TSE050112BBA	TSE050200BBA	TSE050212BBA	TSE050300BBA	TSE000100BBA
42	1	Upper body SMS "T"	TSE150100BBA		TSE150112BBA	TSE150200BBA	TSE150212BBA	TSE150300BBA	TSE100100BBA
50	1	Cap	TOF100040BBA	TOF100040BBA	TOF100040BBA	TOF100050BBA	TOF100065BBA	TOF100080BBA	TOF100100BBA
51	1	Lower shutter	TPA120040BBA	TPA120040BBA	TPA120040BBA	TPA120050BBA	TPA120065BBA	TPA120080BBA	TPA120100BBA
52	1	Plug	TPN000040BBA	TPN000040BBA	TPN000040BBA	TPN000050BBA	TPN000065BBA	TPN000080BBA	TPN000100BBA
53	1	Lower piston	TNE140093LAA	TNE140093LAA	TNE140093LAA	TNE140093LAA	TNE140115LAA	TNE140115LAA	TNE140138LAA
58	1	Adjusting sleeve	TNK000093AAA	TNK000093AAA	TNK000093AAA	TNK000093AAA	TNK000115AAA	TNK000115AAA	TNK000138AAA
60	1	Seal ring EPDM	RAAGM165	RAAGM165	RAAGM165	RAAGM4300	RAAGM4350	RAAGM4400	RAAGM4487
60	1	Seal ring VITON	RAAGD165	RAAGD165	RAAGD165	RAAGD4300	RAAGD4350	RAAGD4400	RAAGD4487
61	1	Seal ring	RAAGA150	RAAGA150	RAAGA150	RAAGA150	RAAGA150	RAAGA150	RAAGA6262
62	1	Seal ring EPDM	TPJGM02606	TPJGM02606	TPJGM02606	TPJGM04106	TPJGM05406	TPJGM06306	TPJGM08406
62	1	Seal ring VIT	TPJGD02606	TPJGD02606	TPJGD02606	TPJGD04106	TPJGD05406	TPJGD06306	TPJGD08406
64	1	Guide bushing	TOJ001045TAA	TOJ001045TAA	TOJ001045TAA	TOJ001059TAA	TOJ001075TAA	TOJ001084TAA	TOJ001106TAA
66	1	Upper piston	TNE120093LAA	TNE120093LAA	TNE120093LAA	TNE120093LAA	TNE120115LAB	TNE120115LAB	TNE120138LAA
69	1	Seal ring EPDM	TPG000045GMA	TPG000045GMA	TPG000045GMA	TPG000059GMA	TPG000075GMA	TPG000084GMA	TPG000106GMA
69	1	Seal ring VIT	TPG000045GDA	TPG000045GDA	TPG000045GDA	TPG000059GDA	TPG000075GDA	TPG000084GDA	TPG000106GDA
70	1	Seal ring EPDM	TPG000045GMA	TPG000045GMA	TPG000045GMA	TPG000059GMA	TPG000075GMA	TPG000084GMA	TPG000106GMA
70	1	Seal ring VIT	TPG000045GDA	TPG000045GDA	TPG000045GDA	TPG000059GDA	TPG000075GDA	TPG000084GDA	TPG000106GDA
74	1	Air connector	RCSOA118	RCSOA118	RCSOA118	RCSOA118	RCSOA118	RCSOA118	RCSOA118
75	1	Air connector	RCSOA118	RCSOA118	RCSOA118	RCSOA118	RCSOA118	RCSOA118	RCSOA118
77	2	Nut	TNQ250000FCA	TNQ250000FCA	TNQ250000FCA	TNQ250000FCA	TNQ250000FCA	TNQ250000FCA	TNQ300000FCA
78	1	Seal ring EPDM	RAAGM4075	RAAGM4075	RAAGM4075	RAAGM4125	RAAGM4187	RAAGM159	RAAGM178
78	1	Seal ring VIT	RAAGD4075	RAAGD4075	RAAGD4075	RAAGD4125	RAAGD4187	RAAGD159	RAAGD178
81	1	Seal ring	RAAGA4350	RAAGA4350	RAAGA4350	RAAGA4350	RAAGA4437	RAAGA4437	RAAGA4525
82	1	Seal ring	RAAGA6337	RAAGA6337	RAAGA6337	RAAGA6337	RAAGA6425	RAAGA6425	RAAGA8500
83	1	Seal ring	RAAGA4081	RAAGA4081	RAAGA4081	RAAGA4081	RAAGA4081	RAAGA4081	RAAGA4112
85	1	Secondary spring	TNS045081FZA	TNS045081FZA	TNS045081FZA	TNS045081FZA	TNS045090FZA	TNS045090FZA	TNS065080FZA
90	1	Seal ring	RAAGA4118	RAAGA4118	RAAGA4118	RAAGA4118	RAAGA4118	RAAGA4118	RAAGA4137
91	1	Seal ring	RAAGA6337	RAAGA6337	RAAGA6337	RAAGA6337	RAAGA6425	RAAGA6425	RAAGA8500
94	1	Seal ring EPDM	TPJGM03306A	TPJGM03306A	TPJGM03306A	TPJGM04706A	TPJGM06206	TPJGM07106	TPJGM09206
94	1	Seal ring VIT	TPJGD03206	TPJGD03206	TPJGD03206	TPJGD04506	TPJGD06106	TPJGD07206	TPJGD09406
101	4	Socket screw	RBAAA08X25	RBAAA08X25	RBAAA08X25	RBAAA08X25	RBAAA08X25	RBAAA08X25	RBAAA08X25
106	1	Guide bushing	TOJ001045TAA	TOJ001045TAA	TOJ001045TAA	TOJ001059TAA	TOJ001075TAA	TOJ001084TAA	TOJ001106TAA
108	1	Seal ring EPDM	RAAGM165	RAAGM165	RAAGM165	RAAGM4300	RAAGM4350	RAAGM4400	RAAGM4487
108	1	Seal ring VIT	RAAGD165	RAAGD165	RAAGD165	RAAGD4300	RAAGD4350	RAAGD4400	RAAGD4487
120	1	Guide bushing	TOJTE03715	TOJTE03715	TOJTE03715	TOJTE03715	TOJTE03715	TOJTE03715	TOJTE03715
121	1	Seal ring	RAAGA4143	RAAGA4143	RAAGA4143	RAAGA4143	RAAGA4143	RAAGA4143	RAAGA6200
126	1	Seal ring EPDM	RAAGM165	RAAGM165	RAAGM165	RAAGM4300	RAAGM4350	RAAGM4400	RAAGM4487
126	1	Seal ring VIT	RAAGD165	RAAGD165	RAAGD165	RAAGD4300	RAAGD4350	RAAGD4400	RAAGD4487
154	1	Gauge	TNP310040LAA	TNP310040LAA	TNP310040LAA		TNP310070LAA		
193	1	Guide bushing	TOJ000016TAA	TOJ000016TAA	TOJ000016TAA	TOJ000028TAA	TOJ000044TAA	TOJ000053TAA	TOJ000069TAA
199	1	Clamp	TOH000090AAA	TOH000090AAA	TOH000090AAA	TOH000105AAA	TOH000119AAA	TOH000130AAA	TOH000155AAA
245	1	Guide pin	TNG101086AAA	TNG101086AAA	TNG101086AAA	TNG101086AAA	TNG101086AAA	TNG101086AAA	TNG101086AAA

model: B925 DN:125 - 150
gaskets material: EPDM/VIT

valve bodies: LL-TT-LT-TL

welding ends
actuator: SE

Pos.	Qty	Description	DN125	DN150
1	1	Lower body DIN "L"	TSA000125BBA	TSA000150BBA
1	1	Lower body DIN "T"	TSA100125BBA	TSA100150BBA
1	1	Lower body SMS "L"	TSA050500BBA	TSA050600BBA
1	1	Lower body SMS "T"	TSA150500BBA	TSA150600BBA
2	1	Upper shutter	TPA100150BBA	TPA100150BBA
4	1	Seal ring	RAAGA226	RAAGA226
9	1	Cylinder	TNC100176AAA	TNC100176AAA
11	1	Pin	TNG100176AAA	TNG100176AAA
12	1	Seal ring	RAAGA3087	RAAGA3087
13	1	Main piston	TNE100176LAA	TNE100176LAA
14	1	Seal ring EPDM	TPJGM11706	TPJGM11706
14	1	Seal ring VIT	TPJGD11706	TPJGD11706
16	1	Seal ring	RAAGA4675	RAAGA4675
17	1	Guide bushing	TOJTE01615	TOJTE01615
18	1	Stopper cylinder	TNA100176AAA	TNA100176AAA
19	1	Seal ring	RAAGA121	RAAGA121
24	1	Air connector	RCSOA118	RCSOA118
31	1	Spring	TNS170340FZA	TNS170340FZA
33	2	Clamp	TOHAA1830	TOHAA1830
34	4	Socket screw	RBAAA10X16	RBAAA10X16
35	1	Part assembling	TOA100150AAA	TOA100150AAA
40	1	Plug	RCS001PSA	RCS001PSA
42	1	Upper body DIN "L"	TSE000125BBA	TSE000150BBA
42	1	Upper body DIN "T"	TSE100125BBA	TSE100150BBA
42	1	Upper body SMS "L"	TSE050500BBA	TSE050600BBA
42	1	Upper body SMS "T"	TSE150500BBA	TSE150600BBA
50	1	Cap	TOF100150BBA	TOF100150BBA
51	1	Lower shutter	TPA120150BBA	TPA120150BBA
52	1	Plug	TPN000150BBA	TPN000150BBA
53	1	Lower piston	TNE140176LAA	TNE140176LAA
58	1	Adjusting sleeve	TNK000176AAA	TNK000176AAA
60	1	Seal ring EPDM	RAAGM4575	RAAGM4575
60	1	Seal ring VIT	RAAGD4575	RAAGD4575
61	1	Seal ring	RAAGA6287	RAAGA6287
62	1	Seal ring EPDM	TPJGM10606	TPJGM10606
62	1	Seal ring VIT	TPJGD10606	TPJGD10606
64	1	Guide bushing	TOJ001128TAA	TOJ001128TAA
66	1	Upper piston	TNE120176LAAA	TNE120176LAAA
69	1	Seal ring EPDM	TPG000128GMA	TPG000128GMA
69	1	Seal ring VIT	TPG000128GDA	TPG000128GDA
70	1	Seal ring EPDM	TPG000128GMA	TPG000128GMA
70	1	Seal ring VIT	TPG000128GDA	TPG000128GDA
74	1	Air connector	RCSOA118	RCSOA118
75	1	Air connector	RCSOA118	RCSOA118
77	2	Nut	TNQ300000FCA	TNQ300000FCA
78	1	Seal ring EPDM	RAAGM6375	RAAGM6375
78	1	Seal ring VIT	RAAGD6375	RAAGD6375
81	1	Seal ring	RAAGA4675	RAAGA4675
82	1	Seal ring	RAAGA228	RAAGA228
83	1	Seal ring	RAAGA4112	RAAGA4112
85	1	Secondary spring	TNS100130FZA	TNS100130FZA
90	1	Seal ring	RAAGA4137	RAAGA4137
91	1	Seal ring	RAAGA228	RAAGA228
94	1	Seal ring EPDM	TPJGM11706	TPJGM11706
94	1	Seal ring VIT	TPJGD11706	TPJGD11706
101	4	Socket screw	RBAAA10X25	RBAAA10X25
106	1	Guide bushing	TOJ001128TAA	TOJ001128TAA
108	1	Seal ring EPDM	RAAGM4575	RAAGM4575
108	1	Seal ring VIT	RAAGD4575	RAAGD4575
120	1	Guide bushing	TOJ002057TEA	TOJ002057TEA
121	1	Seal ring	RAAGA6225	RAAGA6225
126	1	Seal ring EPDM	RAAGM4575	RAAGM4575
126	1	Seal ring VIT	RAAGD4575	RAAGD4575
193	1	Guide bushing	TOJ000091TAA	TOJ000091TAA
199	1	Clamp	TOHAA1830	TOHAA1830
245	1	Guide pin	TNG101086AAA	TNG101086AAA

model: B925 DN:25 - - 150
gaskets material: EPDM/VIT

valve bodies: LL-TT-LT-TL

welding ends
actuator: SE

	DN25 - - 40	DN50 - 50.8	DN65 - 63.5	DN80 - 76.1	DN100 - 101.6	DN125 - 150
Service KIT wetted part EPDM	TTABCW040E	TTABCW050E	TTABCW065E	TTABCW080E	TTABCW100E	TTABCW125E
Service KIT wetted part VIT	TTABCW040V	TTABCW050V	TTABCW065V	TTABCW080V	TTABCW100V	TTABCW125V
Position	14 - 60 - 62 - 69 - 70 - 78 - 94 - 108 - 126					

Cylinder service KIT NBR	TTEBCW093G	TTEBCW093G	TTEBCW115G	TTEBCW115G	TTEBCW138G	TTEBCW176G
Position	4 - 12 - 16 - 19 - 61 - 81 - 82 - 83 - 90 - 91 - 121					

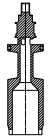
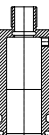
	Lower shutters plus seal ring EPDM	QPA120040BBAE	QPA120050BBAE	QPA120065BBAE	QPA120080BBAE	QPA120100BBAE	QPA120125BBAE
	Lower shutters plus seal ring VIT	QPA120040BBAV	QPA120050BBAV	QPA120065BBAV	QPA120080BBAV	QPA120100BBAV	QPA120125BBAV
	Position	51 - 78 - 94 - 193					
	Upper shutters plus seal ring EPDM	QPA100040BBAE	QPA100050BBAE	QPA100065BBAE	QPA100080BBAE	QPA100100BBAE	QPA100125BBAE
	Upper shutters plus seal ring VIT	QPA100040BBAV	QPA100050BBAV	QPA100065BBAV	QPA100080BBAV	QPA100100BBAV	QPA100125BBAV
	Position	2 - 14 - 62					

	Pre assembled cylinder plus york plus shutter EPDM	QNC100093AAA00E	QNC100093AAA01E	QNC100115AAA00E	QNC100115AAA01E	QNC100138AAA01E	QNC100176AAA01E
	Pre assembled cylinder plus york plus shutter VIT	QNC100093AAA00V	QNC100093AAA01V	QNC100115AAA00V	QNC100115AAA01V	QNC100138AAA01V	QNC100176AAA01V
	Position	2 - 4 - 9 - 11 - 12 - 13 - 14 - 16 - 17 - 18 - 19 - 24 - 31 - 34 - 35 - 40 - 50 - 51 - 53 - 58 - 60 - 61 - 62 - 66 - 70 - 74 - 75 77 - 78 - 81 - 82 - 83 - 85 - 90 - 91 - 94 - 101 - 106 - 120 - 121 - 154 - 193 - 245					

model: B925 DN:25 - - 150
gaskets material: EPDM/VIT

valve bodies: LLL-TTT

welding ends
actuator: SE

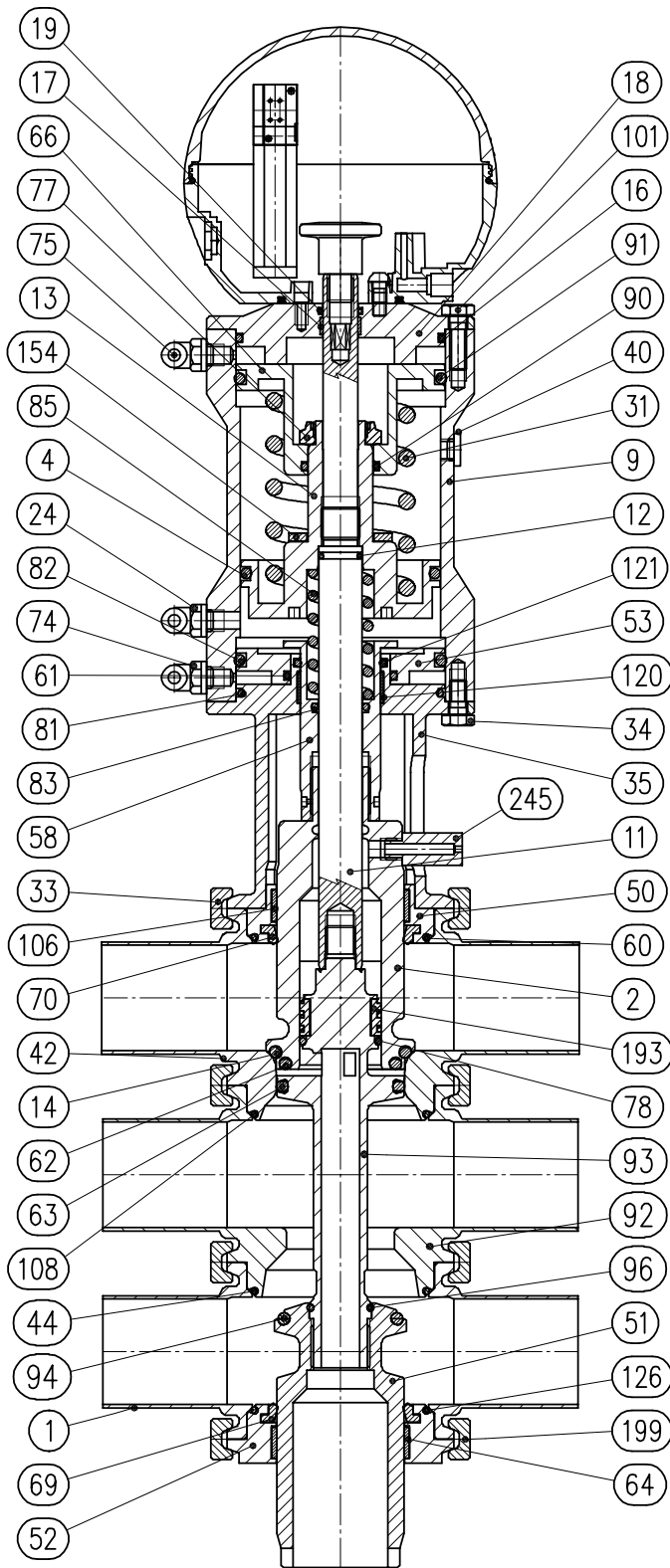

245	Perno guida/Pin guide
199	Morsetto/Clamp
193	Boccola/Guide bushing
154	Spessore / Gauge
126	Anello di tenuta/Seal ring
121	Anello di tenuta/Seal ring
120	Boccola/Guide bushing
108	Anello di tenuta/Seal ring
106	Boccola/Guide bushing
101	Vite/Socket screw
96	Anello di tenuta/Seal ring
94	Anello di tenuta/Seal ring
93	Otturatore intermedio/Shutter middle
92	Corpo intermedio/Body middle
91	Anello di tenuta/Seal ring
90	Anello di tenuta/Seal ring
85	Molla secondaria/Secondary spring
83	Anello di tenuta/Seal ring
82	Anello di tenuta/Seal ring
81	Anello di tenuta/Seal ring
78	Anello di tenuta/Seal ring
77	Dado/Nut
75	Raccordo aria/Lower connectios
74	Raccordo Aria/Lower connection
70	Anello di tenuta/Seal ring
69	Anello di tenuta/Seal ring
66	Pistone superiore/Piston upper
64	Boccola/Guide Bushing
63	Anello di tenuta/Seal ring
62	Anello di tenuta/Seal ring
61	Anello di tenuta/Seal ring
60	Anello di tenuta/Seal ring
58	Manicotto di trascinamento/Adjusting sleeve
53	Pistone inferiore/Piston lower
52	Tappo/Plug
51	Otturatore inferiore/Shutter lower
50	Disco portatenuta/Cap
44	Anello di tenuta/Seal ring
42	Corpo superiore/Body upper
40	Tappo/Plug
35	Assemblaggio/Part assembling
34	Vite/Socket scwew
33	Morsetto/Clamp
31	Molla/Spring
24	Raccordo aria/Lower connection
19	Anello di tenuta/Seal ring
18	Tampone/Stopper
17	Boccola/Guide bushing
16	Anello di tenuta/Seal ring
14	Anello di tenuta/Seal ring
13	Pistone centrale/Piston main
12	Anello di tenuta/Seal ring
11	Perno/Pin
9	Cilindro/Cylinder
4	Anello di tenuta/Seal ring
2	Otturatore superiore/Shutter upper
1	Corpo inferiore/Body lower
Pos.	Descrizione

model: B925 DN:25 - - 100
gaskets material: EPDM/VIT

valve bodies: LLL-TTT

welding ends
actuator: SE

Pos.	Q.ty	Description	DN25-25.4	DN32	DN40-38.1	DN50-50.8	DN65-63.5	DN80-76.1	DN100-101.6
1	1	Lower body DIN "L"	TSA000025BBA	TSA000032BBA	TSA000040BBA	TSA000050BBA	TSA000065BBA	TSA000080BBA	TSA000100BBA
1	1	Lower body DIN "T"	TSA100025BBA	TSA100032BBA	TSA100040BBA	TSA100050BBA	TSA100065BBA	TSA100080BBA	TSA100100BBA
1	1	Lower body SMS "L"	TSA050100BBA		TSA050112BBA	TSA050200BBA	TSA050212BBA	TSA050300BBA	TSA000100BBA
1	1	Lower body SMS "T"	TSA150100BBA		TSA150112BBA	TSA150200BBA	TSA150212BBA	TSA150300BBA	TSA100100BBA
2	1	Upper shutter	TPA100040BBA	TPA100040BBA	TPA100040BBA	TPA100050BBA	TPA100065BBA	TPA100080BBA	TPA100100BBA
4	1	Seal ring	RAAGA6325	RAAGA6325	RAAGA6325	RAAGA6325	RAAGA6412	RAAGA6412	RAAGA204
9	1	Cylinder	TNC100093AAA	TNC100093AAA	TNC100093AAA	TNC100093AAA	TNC100115AAA	TNC100115AAA	TNC100138AAA
11	1	Pin	TNG100093AAA	TNG100093AAA	TNG100093AAA	TNG100093AAA	TNG100115AAA	TNG100115AAA	TNG100138AAA
12	1	Seal ring	RAAGA119	RAAGA119	RAAGA119	RAAGA119	RAAGA119	RAAGA119	RAAGA3087
13	1	Main piston	TNE100093LAA	TNE100093LAA	TNE100093LAA	TNE100093LAA	TNE100115LAB	TNE100115LAB	TNE100138LAA
14	1	Seal ring EPDM	TPJGM03806	TPJGM03806	TPJGM03806	TPJGM05106	TPJGM06506	TPJGM07406	TPJGM09706
14	1	Seal ring VIT	TPJGD03806	TPJGD03806	TPJGD03806	TPJGD05106	TPJGD06506	TPJGD07406	TPJGD09706
16	1	Seal ring	RAAGA4350	RAAGA4350	RAAGA4350	RAAGA4350	RAAGA4437	RAAGA4437	RAAGA4525
17	1	Guide bushing	TOJTE01615	TOJTE01615	TOJTE01615	TOJTE01615	TOJTE01615	TOJTE01615	TOJTE01615
18	1	Stopper cylinder	TNA100093AAA	TNA100093AAA	TNA100093AAA	TNA100093AAA	TNA100115AAA	TNA100115AAA	TNA100138AAA
19	1	Seal ring	RAAGA121	RAAGA121	RAAGA121	RAAGA121	RAAGA121	RAAGA121	RAAGA121
24	1	Air connector	RCSOA118	RCSOA118	RCSOA118	RCSOA118	RCSOA118	RCSOA118	RCSOA118
31	1	Spring	TNS070220FZA	TNS070220FZA	TNS070220FZA	TNS070220FZA	TNS090210FZA	TNS090210FZA	TNS120240FZA
33	3	Clamp	TOH000090AAA	TOH000090AAA	TOH000090AAA	TOH000105AAA	TOH000119AAA	TOH000130AAA	TOH000155AAA
34	4	Socket screw	RBAAA08X16	RBAAA08X16	RBAAA08X16	RBAAA08X16	RBAAA08X16	RBAAA08X16	RBAAA08X16
35	1	Part assembling	TOA100040AAA	TOA100040AAA	TOA100040AAA	TOA100050AAA	TOA100065AAB	TOA100080AAB	TOA100100AAA
40	1	Plug	ORCS001PSA	ORCS001PSA	ORCS001PSA	RCS001PSA	RCS001PSA	RCS001PSA	RCS001PSA
42	1	Upper body DIN "L"	TSE000025BBA	TSE000032BBA	TSE000040BBA	TSE000050BBA	TSE000065BBA	TSE000080BBA	TSE000100BBA
42	1	Upper body DIN "T"	TSE100025BBA	TSE100032BBA	TSE100040BBA	TSE100050BBA	TSE100065BBA	TSE100080BBA	TSE100100BBA
42	1	Upper body SMS "L"	TSE050100BBA		TSE050112BBA	TSE050200BBA	TSE050212BBA	TSE050300BBA	TSE000100BBA
42	1	Upper body SMS "T"	TSE150100BBA		TSE150112BBA	TSE150200BBA	TSE150212BBA	TSE150300BBA	TSE100100BBA
44	1	Seal ring EPDM	RAAGM165	RAAGM165	RAAGM165	RAAGM4300	RAAGM4350	RAAGM4400	RAAGM4487
44	1	Seal ring VIT	RAAGD165	RAAGD165	RAAGD165	RAAGD4300	RAAGD4350	RAAGD4400	RAAGD4487
50	1	Cap	TOF100040BBA	TOF100040BBA	TOF100040BBA	TOF100050BB	TOF100065BBA	TOF100080BBA	TOF100100BBA
51	1	Lower shutter	TPA160040BBA	TPA160040BBA	TPA160040BBA	TPA160050BBA	TPA160065BBA	TPA160080BBA	TPA160100BBA
52	1	Plug	TPN000040BBA	TPN000040BBA	TPN000040BBA	TPN000050BBA	TPN000065BBA	TPN000080BBA	TPN000100BBA
53	1	Lower piston	OTNE140093LAA	OTNE140093LAA	OTNE140093LAA	TNE140093LAA	TNE140115LAA	TNE140115LAA	TNE140138LAA
58	1	Adjusting sleeve	TNK000093AAA	TNK000093AAA	TNK000093AAA	TNK000093AAA	TNK000115AAA	TNK000115AAA	TNK000138AAA
60	1	Seal ring EPDM	RAAGM165	RAAGM165	RAAGM165	RAAGM4300	RAAGM4350	RAAGM4400	RAAGM4487
60	1	Seal ring VIT	RAAGD165	RAAGD165	RAAGD165	RAAGD4300	RAAGD4350	RAAGD4400	RAAGD4487
61	1	Seal ring	RAAGA150	RAAGA150	RAAGA150	RAAGA150	RAAGA150	RAAGA150	RAAGA6262
62	1	Seal ring EPDM	TPJGM02606	TPJGM02606	TPJGM02606	TPJGM04106	TPJGM05406	TPJGM06306	TPJGM08406
62	1	Seal ring VIT	TPJGD02606	TPJGD02606	TPJGD02606	TPJGD04106	TPJGD05406	TPJGD06306	TPJGD08406
63	1	Seal ring EPDM	TPJGM03306A	TPJGM03306A	TPJGM03306A	TPJGM04706A	TPJGM06206	TPJGM07106	TPJGM09206
63	1	Seal ring VIT	TPJGD03206	TPJGD03206	TPJGD03206	TPJGD04506	TPJGD06106	TPJGD07206	TPJGD09406
64	1	Guide bushing	TOJ001045TAA	TOJ001045TAA	TOJ001045TAA	TOJ001059TAA	TOJ001075TAA	TOJ001084TAA	TOJ001106TAA
66	1	Upper piston	TNE120093LAA	TNE120093LAA	TNE120093LAA	TNE120093LAA	TNE120115LAB	TNE120115LAB	TNE120138LAA
69	1	Seal ring EPDM	TPG000045GMA	TPG000045GMA	TPG000045GMA	TPG000059GMA	TPG000075GMA	TPG000084GMA	TPG000106GMA
69	1	Seal ring VIT	TPG000045GDA	TPG000045GDA	TPG000045GDA	TPG000059GDA	TPG000075GDA	TPG000084GDA	TPG000106GDA
70	1	Seal ring EPDM	TPG000045GMA	TPG000045GMA	TPG000045GMA	TPG000059GMA	TPG000075GMA	TPG000084GMA	TPG000106GMA
70	1	Seal ring VIT	TPG000045GDA	TPG000045GDA	TPG000045GDA	TPG000059GDA	TPG000075GDA	TPG000084GDA	TPG000106GDA
74	1	Air connector	RCSOA118	RCSOA118	RCSOA118	RCSOA118	RCSOA118	RCSOA118	RCSOA118
75	1	Air connector	RCSOA118	RCSOA118	RCSOA118	RCSOA118	RCSOA118	RCSOA118	RCSOA118
77	2	Nut	TNQ250000FCA	TNQ250000FCA	TNQ250000FCA	TNQ250000FCA	TNQ250000FCA	TNQ250000FCA	TNQ300000FCA
78	1	Seal ring EPDM	RAAGM4075	RAAGM4075	RAAGM4075	RAAGM4125	RAAGM4187	RAAGM159	RAAGM178
78	1	Seal ring VIT	RAAGD4075	RAAGD4075	RAAGD4075	RAAGD4125	RAAGD4187	RAAGD159	RAAGD178
81	1	Seal ring	0RAAGA4350	0RAAGA4350	0RAAGA4350	RAAGA4350	RAAGA4437	RAAGA4437	RAAGA4525
82	1	Seal ring	RAAGA6337	RAAGA6337	RAAGA6337	RAAGA6337	RAAGA6425	RAAGA6425	RAAGA8500
83	1	Seal ring	RAAGA4081	RAAGA4081	RAAGA4081	RAAGA4081	RAAGA4081	RAAGA4081	RAAGA4112
85	1	Secondary spring	TNS045081FZA	TNS045081FZA	TNS045081FZA	TNS045081FZA	TNS045090FZA	TNS045090FZA	TNS065080FZA
90	1	Seal ring	RAAGA4118	RAAGA4118	RAAGA4118	RAAGA4118	RAAGA4118	RAAGA4118	RAAGA4137
91	1	Seal ring	RAAGA6337	RAAGA6337	RAAGA6337	RAAGA6337	RAAGA6425	RAAGA6425	RAAGA8500
92	1	Middle body DIN "L"	TSI000025BBA	TSI000032BBA	TSI000040BBA	TSI000050BBA	TSI000065BBA	TSI000080BBA	TSI000100BBA
92	1	Middle body DIN "T"	TSI100025BBA	TSI100032BBA	TSI100040BBA	TSI100050BBA	TSI100065BBA	TSI100080BBA	TSI100100BBA
92	1	Middle body SMS "L"	TSI050100BBA		TSI050112BBA	TSI050200BBA	TSI050212BBA	TSI050300BBA	TSI000100BBA
92	1	Middle body SMS "T"	TSI150100BBA		TSI150112BBA	TSI150200BBA	TSI150212BBA	TSI150300BBA	TSI100100BBA
93	1	Middle Shutter	TPA140040BBA	TPA140040BBA	TPA140040BBA	TPA140050BBA	TPA140065BBA	TPA140080BBA	TPA140100BBA
94	1	Seal ring EPDM	TPJGM03106	TPJGM03106	TPJGM03106	TPJGM04106	TPJGM05906	TPJGM06806	TPJGM08906
94	1	Seal ring VIT	TPJGD03106	TPJGD03106	TPJGD03106	TPJGD04106	TPJGD05906	TPJGD06806	TPJGD08906
96	1	Seal ring EPDM	RAAGM3068	RAAGM3068	RAAGM3068	RAAGM3093	RAAGM3112	RAAGM3112	RAAGM3156
96	1	Seal ring VIT	RAAGD3068	RAAGD3068	RAAGD3068	RAAGD3093	RAAGD3112	RAAGD3112	RAAGD3156
101	4	Socket screw	RBAAA08X25	RBAAA08X25	RBAAA08X25	RBAAA08X25	RBAAA08X25	RBAAA08X25	RBAAA08X25
106	1	Guide bushing	TOJ001045TAA	TOJ001045TAA	TOJ001045TAA	TOJ001059TAA	TOJ001075TAA	TOJ001084TAA	TOJ001106TAA
108	1	Seal ring EPDM	RAAGM165	RAAGM165	RAAGM165	RAAGM4300	RAAGM4350	RAAGM4400	RAAGM4487
108	1	Seal ring VIT	RAAGD165	RAAGD165	RAAGD165	RAAGD4300	RAAGD4350	RAAGD4400	RAAGD4487
120	1	Guide bushing	TOJTE03715	TOJTE03715	TOJTE03715	TOJTE0371	TOJTE03715	TOJTE03715	TOJ002050TEA
121	1	Seal ring	RAAGA4143	RAAGA4143	RAAGA4143	RAAGA4143	RAAGA4143	RAAGA4143	RAAGA6200
126	1	Seal ring EPDM	RAAGM165	RAAGM165	RAAGM165	RAAGM4300	RAAGM4350	RAAGM4400	RAAGM4487
126	1	Seal ring VIT	RAAGD165	RAAGD165	RAAGD165	RAAGD4300	RAAGD4350	RAAGD4400	RAAGD4487
154	1	Gauge	TNP310040LAA	TNP310040LAA	TNP310040LAA		TNP310070LAA		
193	1	Guide bushing	TOJ000016TAA	TOJ000016TAA	TOJ000016TAA	TOJ000028TAA	TOJ000044TAA	TOJ000053TAA	TOJ000069TAA
199	1	Clamp	TOH000090AAA	TOH000090AAA	TOH000090AAA	TOH000105AAA	TOH000119AAA	TOH000130AAA	TOH000155AAA
245	1	Guide pin	TNG101086AAA	TNG101086AAA	TNG101086AAA	TNG101086AAA	TNG101086AAA	TNG101086AAA	TNG101086AAA

model: B925 DN:125 - 150
gaskets material: EPDM/VIT

valve bodies: LLL-TTT

welding ends
actuator: SE

Pos.	Q.ty	Description	DN125	DN150
1	1	Lower body DIN "L"	TSA000125BBA	TSA000150BBA
1	1	Lower body DIN "T"	TSA100125BBA	TSA100150BBA
1	1	Lower body SMS "L"	TSA050500BBA	TSA050600BBA
1	1	Lower body SMS "T"	TSA150500BBA	TSA150600BBA
2	1	Upper shutter	TPA100150BBA	TPA100150BBA
4	1	Seal ring	RAAGA226	RAAGA226
9	1	Cylinder	TNC100176AAA	TNC100176AAA
11	1	Pin	TNG100176AAA	TNG100176AAA
12	1	Seal ring	RAAGA3087	RAAGA3087
13	1	Main piston	TNE100176LAA	TNE100176LAA
14	1	Seal ring EPDM	TPJGM11706	TPJGM11706
14	1	Seal ring VIT	TPJGD11706	TPJGD11706
16	1	Seal ring	RAAGA4675	RAAGA4675
17	1	Guide bushing	TOJTE01615	TOJTE01615
18	1	Stopper cylinder	TNA100176AAA	TNA100176AAA
19	1	Seal ring	RAAGA121	RAAGA121
24	1	Air connector	RCSOA118	RCSOA118
31	1	Spring	TNS170340FZA	TNS170340FZA
33	3	Clamp	TOHAA1830	TOHAA1830
34	4	Socket screw	RBAAA10X16	RBAAA10X16
35	1	Part assembling	TOA100150AAA	TOA100150AAA
40	1	Plug	RCS001PSA	RCS001PSA
42	1	Upper body DIN "L"	TSE000125BBA	TSE000150BBA
42	1	Upper body DIN "T"	TSE100125BBA	TSE100150BBA
42	1	Upper body SMS "L"	TSE050500BBA	TSE050600BBA
42	1	Upper body SMS "T"	TSE150500BBA	TSE150600BBA
44	1	Seal ring EPDM	RAAGM4575	RAAGM4575
44	1	Seal ring VIT	RAAGD4575	RAAGD4575
50	1	Cap	TOF100150BBA	TOF100150BBA
51	1	Lower shutter	TPA160150BBA	TPA160150BBA
52	1	Plug	TPN000150BBA	TPN000150BBA
53	1	Lower piston	TNE140176LAA	TNE140176LAA
58	1	Adjusting sleeve	TNK000176AAA	TNK000176AAA
60	1	Seal ring EPDM	RAAGM4575	RAAGM4575
60	1	Seal ring VIT	RAAGD4575	RAAGD4575
61	1	Seal ring	RAAGA6287	RAAGA6287
62	1	Seal ring EPDM	TPJGM10606	TPJGM10606
62	1	Seal ring VIT	TPJGD10606	TPJGD10606
63	1	Seal ring EPDM	TPJGM11706	TPJGM11706
63	1	Seal ring VIT	TPJGD11706	TPJGD11706
64	1	Guide bushing	TOJ001128TAA	TOJ001128TAA
66	1	Upper piston	TNE120176LAA	TNE120176LAA
69	1	Seal ring EPDM	TPG000128GMA	TPG000128GMA
69	1	Seal ring VIT	TPG000128GDA	TPG000128GDA
70	1	Seal ring EPDM	TPG000128GMA	TPG000128GMA
70	1	Seal ring VIT	TPG000128GDA	TPG000128GDA
74	1	Air connector	RCSOA118	RCSOA118
75	1	Air connector	RCSOA118	RCSOA118
77	2	Nut	TNQ300000FCA	TNQ300000FCA
78	1	Seal ring EPDM	RAAGM6375	RAAGM6375
78	1	Seal ring VIT	RAAGD6375	RAAGD6375
81	1	Seal ring	RAAGA4675	RAAGA4675
82	1	Seal ring	RAAGA228	RAAGA228
83	1	Seal ring	RAAGA4112	RAAGA4112
85	1	Secondary spring	TNS100130FZA	TNS100130FZA
90	1	Seal ring	RAAGA4137	RAAGA4137
91	1	Seal ring	RAAGA228	RAAGA228
92	1	Middle body DIN "L"	TSI000125BBA	TSI000150BBA
92	1	Middle body DIN "T"	TSI100125BBA	TSI100150BBA
92	1	Middle body SMS "L"	TSI050500BBA	TSI050600BBA
92	1	Middle body SMS "T"	TSI150500BBA	TSI150600BBA
93	1	Middle shutter	TPA140150BBA	TPA140150BBA
94	1	Seal ring EPDM	TPJGM11906	TPJGM11906
94	1	Seal ring VIT	TPJGD11906	TPJGD11906
96	1	Seal ring EPDM	RAAGM3193	RAAGM3193
96	1	Seal ring VIT	RAAGD3193	RAAGD3193
101	4	Socket screw	RBAAA10X25	RBAAA10X25
106	1	Guide bushing	TOJ001128TAA	TOJ001128TAA
108	1	Seal ring EPDM	RAAGM4575	RAAGM4575
108	1	Seal ring VIT	RAAGD4575	RAAGD4575
120	1	Guide bushing	TOJ002057TEA	TOJ002057TEA
121	1	Seal ring	RAAGA6225	RAAGA6225
126	1	Seal ring EPDM	RAAGM4575	RAAGM4575
126	1	Seal ring VIT	RAAGD4575	RAAGD4575
193	1	Guide bushing	TOJ000091TAA	TOJ000091TAA
199	1	Clamp	TOHAA1830	TOHAA1830
245	1	Guide pin	TNG101086AAA	TNG101086AAA

model: B925 DN:25 - - 150
gaskets material: EPDM/VIT



valve bodies: LLL-TTT

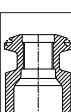
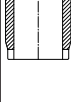

welding ends
actuator: SE

	DN25 - - 40	DN50 - 50.8	DN65 - 63.5	DN80 - 76.1	DN100 - 101.6	DN125 - 150
Service KIT wetted part EPDM	TTCBCW040E	TTCBCW050E	TTCBCW065E	TTCBCW080E	TTCBCW100E	TTCBCW125E
Service KIT wetted part VIT	TTCBCW040V	TTCBCW050V	TTCBCW065V	TTCBCW080V	TTCBCW100V	TTCBCW125V
Position	14 - 44 - 60 - 62 - 63 - 69 - 70 - 78 - 94 - 96 - 108 - 126					

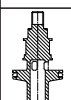
Cylinder service KIT NBR	TTEBCW093G	TTEBCW093G	TTEBCW115G	TTEBCW115G	TTEBCW138G	TTEBCW176G
Position	4 - 12 - 16 - 19 - 61 - 81 - 82 - 83 - 90 - 91 - 121					

	Lower shutter for divert type plus seal ring EPDM	QPA160040BBAE	QPA160050BBAE	QPA160065BBAE	QPA160080BBAE	QPA160100BBAE	QPA160150BBAE
	Lower shutter for divert type plus seal ring VIT	QPA160040BBAV	QPA160050BBAV	QPA160065BBAV	QPA160080BBAV	QPA160100BBAV	QPA160150BBAV
Position	51 - 94						

	Middle shutter plus ring EPDM	QPA140040BBAE	QPA140050BBAE	QPA140065BBAE	QPA140080BBAE	QPA140100BBAE	QPA140150BBAE
	Middle shutter plus ring VIT	QPA140040BBAV	QPA140050BBAV	QPA140065BBAV	QPA140080BBAV	QPA140100BBAV	QPA140150BBAV
Position	63 - 78 - 93 - 96 - 193						

	Upper shutter plus ring VIT	QPA100040BBAE	QPA100050BBAE	QPA100065BBAE	QPA100080BBAE	QPA100100BBAE	QPA100150BBAE
	Upper shutter plus ring VIT	QPA100040BBAV	QPA100050BBAV	QPA100065BBAV	QPA100080BBAV	QPA100100BBAV	QPA100150BBAV
Position	2 - 14 - 62						

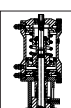
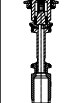
	Pre assembled cylinder plus york plus shutter EPDM	QNC100093AAA10E	QNC100093AAA11E	QNC100115AAA10E	QNC100115AAA11E	QNC100138AAA00E	QNC100176AAA00E
	Pre assembled cylinder plus york plus shutter VIT	QNC100093AAA10V	QNC100093AAA11V	QNC100115AAA10V	QNC100115AAA11V	QNC100138AAA00V	QNC100176AAA00V
Position	2 - 4 - 9 - 11 - 12 - 13 - 14 - 16 - 17 - 18 - 19 - 24 - 31 - 34 - 35 - 40 - 50 - 51 - 53 - 58 - 60 - 61 - 62 - 63 - 66 - 70 - 74 - 75 - 77 - 78 - 81 - 82 - 83 - 85 - 90 - 91 - 93 - 94 - 96 - 101 - 106 - 120 - 121 - 154 - 193 - 245						

Recommendations

- 1.** Consultation of the “Instruction, Use and Maintenance Manual” is mandatory prior to the installation, use and maintenance of the products of all Products. All the information, indications, specifications, technical details provided herein are based on test data which the Manufacturer Bardiani Valvole S.p.A. holds to be reliable nevertheless the above is not deemed to be assumed as fully exhaustive inasmuch as not every possible use has been envisaged.
- 2.** All the illustrations and drawings provided are to be intended as indicative and therefore not binding, the illustrations being for presentation purposes only.
- 3.** It is the Buyer’s duty to assess the suitability of the products for the use he intends to make of the same prior to placing the order as he/she will take the risks and accept liability in case of incorrect choice and use of the Products.
- 4.** The Manufacturer strongly recommends the Buyer to contact their sales team and request any information that might be needed in relation to the specifications and uses of the Products.
- 5.** The information provided in this manual refers to the standard products manufactured by Bardiani Valvole S.p.A. and therefore cannot be assumed to apply to customized products as well.
- 6.** Bardiani Valvole S.p.A. reserves the right to amend and/or integrate and/or update the data and/or information and/or technical details relative to Products at any time and without prior notice. Please visit the website www.bardiani.com, where the latest updated of the “Instruction, Use and Maintenance Manual” can be found”.
- 7.** The content and validity of the warranty covering the Products of Bardiani Valvole S.p.A are dealt with in the relevant section in the “Instruction, Use and Maintenance Manual” which constitutes an integral part of the Products themselves.
- 8.** Bardiani Valvole S.p.A., shall not in any way be held liable for immaterial, indirect and consequential damages, such as (by way of example only), damages or loss of business, contracts, opportunities, time, production, profits, goodwill, image etc..